

Elia Garcia
Mayor
Rene Rodriguez
At Large
Cesar Nevarez
District 1/Mayor ProTem



Ralph Duran
District 2
Victor Perez
District 3
Yvonne Colon-Villalobos
District 4
Adriana Rodarte
City Manager

**NOTICE OF SPECIAL COUNCIL MEETING
OF THE CITY COUNCIL
OF THE
CITY OF SOCORRO**

.....
THE FACILITY IS WHEELCHAIR ACCESSIBLE AND ACCESSIBLE PARKING SPACES ARE AVAILABLE. REQUESTS FOR ACCOMMODATION FOR INTERPRETIVE SERVICES MUST BE MADE 48 HOURS PRIOR TO THIS MEETING. PLEASE CONTACT THE CITY CLERK'S OFFICE AT (915) 858-2915 FOR FURTHER INFORMATION.

SUPPLEMENTAL NOTICE OF MEETING BY VIRTUAL SERVICES

IN ACCORDANCE WITH ORDER OF THE OFFICE OF THE GOVERNOR ISSUED MARCH 16, 2020, THE CITY COUNCIL OF THE CITY OF SOCORRO WILL CONDUCT THE MEETING SCHEDULED FOR THURSDAY NOVEMBER 12, 2020 AT 6:00 PM BROADCASTED FROM CITY COUNCIL CHAMBERS AT 860 RIO VISTA., RD. SOCORRO, TEXAS VIA TELEPHONE CONFERENCE AND LIVED STREAMED IN ORDER TO ADVANCE THE PUBLIC HEALTH GOAL OF LIMITING THE NUMBER OF PEOPLE PHYSICALLY PRESENT AT OUR LOCATION (ALSO CALLED "SOCIAL DISTANCING") TO SLOW THE SPREAD OF THE CORONAVIRUS (COVID-19). THERE WILL BE NO PUBLIC ACCESS TO THE LOCATION DESCRIBED BELOW.

THIS WRITTEN NOTICE, THE MEETING AGENDA, AND THE AGENDA PACKET, ARE POSTED ONLINE AT [HTTP://CI.SOCORRO.TX.US/CITY-CLERK-PUBLIC-NOTICE](http://ci.socorro.tx.us/city-clerk-public-notice) THE PUBLIC CAN ACCESS THE MEETING BY CALLING TOLL FREE-NUMBER 844-854-2222 ACCESS CODE 323610.

THE PUBLIC MUST CALL IN 844-854-2222 ACCESS CODE 323610 BY 5:30 PM MOUNTAIN STANDARD TIME (MST) ON NOVEMBER 12, 2020 TO SIGN UP FOR PUBLIC COMMENT AND THE AGENDA ITEM THEY WISH TO COMMENT ON. THE PUBLIC THAT SIGNED UP TO SPEAK WILL BE CALLED UPON BY THE PRESIDING OFFICER DURING THE MEETING.

-
1. Call to order
 2. Pledge of Allegiance and a Moment of Silence

3. Establishment of Quorum

PUBLIC COMMENT

- 4. Public Comment** (The maximum time for public comment will be 30 minutes and three minutes will be allotted for each speaker. Government Code 551.042 allows for responses by city council to be a statement of specific factual information given in response to the inquiry; or a recitation of existing policy in response to the inquiry; or a decision to add the public comment to a future agenda.)

NOTICE TO THE PUBLIC

ALL MATTERS LISTED UNDER THE CONSENT AGENDA, INCLUDING THOSE ON THE ADDENDUM TO THE AGENDA, WILL BE CONSIDERED BY THE CITY COUNCIL TO BE ROUTINE AND WILL BE ENACTED BY ONE MOTION. THERE WILL BE NO SEPARATE DISCUSSION ON THESE ITEMS UNLESS CITY COUNCIL MEMBERS REMOVE SPECIFIC ITEMS FROM THE CONSENT AGENDA TO THE REGULAR AGENDA FOR DISCUSSION PRIOR TO THE TIME THE CITY COUNCIL MEMBERS VOTE ON THE MOTION TO ADOPT THE CONSENT AGENDA.

ITEMS REMOVED FROM THE CONSENT AGENDA TO THE REGULAR AGENDA WILL BE CONSIDERED BY THE CITY COUNCIL AFTER ACTING ON THE CONSENT AGENDA.

ANY MATTERS LISTED ON THE CONSENT AGENDA AND THE REGULAR AGENDA MAY BE DISCUSSED IN EXECUTIVE SESSION AT THE OPTION OF THE CITY OF SOCORRO CITY COUNCIL FOLLOWING VERBAL ANNOUNCEMENT, IF AN APPROPRIATE EXCEPTION TO THE OPEN MEETING REQUIREMENT OF THE TEXAS OPEN MEETINGS ACT IS APPLICABLE.

CONSENT AGENDA

PUBLIC COMMENTS ARE NOT TAKEN DURING THE INTRODUCTION OF ORDINANCES. PUBLIC COMMENTS WILL BE ALLOWED AT THE SCHEDULED PUBLIC HEARING-ORDINANCE 320

- 5. *Excuse* absent council members. *Olivia Navarro***
- 6. *Approval* of Regular Council Meeting Minutes of October 15, and Special Council Minutes October 19, 2020. *Olivia Navarro***
- 7. *Discussion and action* to approve September 2020 Accounts Payable Report. *Charles Casiano***
- 8. *Discussion and action* to approve September 2020 Cash Receipts Report. *Charles Casiano***

9. **Discussion and action** to approve September 2020 Unaudited Financial Report.

Charles Casiano

10. **Introduction, First Reading and calling for a Public Hearing** of an Ordinance to amend Chapter 46 (Zoning), Sections 46-239 (Accessory Structures), 46-263 (Accessory Structures), 46-329 (Accessory Structures), 46-352 (Accessory Structures), and 46-623 (Accessory Building) to reduce rear setback requirements for accessory structures.

Job Terrazas

REGULAR AGENDA

GRANTS DEPARTMENT

11. **Discussion and action** to approve the submission of a grant application to the Texas Historical Commission's FY 2021 Certified Local Government Program to offset the costs of an interactive website and virtual map/tour of the Rio Vista Farm Historic District to educate the public about the complex history of the site and increase accessibility to the site. There is a match requirement of 1:1.

Alejandra Valadez

PLANNING AND ZONING DEPARTMENT

12. **Discussion and action** on the final plat approval for Sendero Flores Village being all of Tracts 4B, 4C, Socorro Grant, Block 25 for a new development.

Job Terrazas

13. **Discussion and action** to approve a Neighborhood Traffic Management Pilot Program.

Michael Medina

CITY MANAGER

14. **Discussion and action** regarding Texas Gas Service Elizabeth O'hara and Jasmine King-Bush regarding Energy Efficiency Program.

Adriana Rodarte

15. **Discussion and action** to approve Resolution 628 canvassing the returns of the General Election and Charter Amendment Election held November 3, 2020.

Adriana Rodarte

16. **Discussion and action** to approve an order calling for a Runoff Election to be held on December 12, 2020, from the General Election in the Offices of Mayor, AtLarge Representative and District 4 Representative.

Adriana Rodarte

The City Council of the City of Socorro may retire into EXECUTIVE SESSION pursuant to Section 3.08 of the City of Socorro Charter and the Texas Government Code, Sections 551, Subchapter D to discuss any of the following: (The items listed below are matters of the sort routinely discuss in Executive Session, but the City Council of the City of Socorro may move to Executive Session any of the items on this agenda, consistent with the terms of the Open Meetings Act.) The City Council will return to open session to take any final action and may also, at any time during the meeting, bring forward any of the following items for public discussion, as appropriate.

Section 551.071 CONSULTATIONS WITH ATTORNEY
Section 551.072 DELIBERATION REGARDING REAL PROPERTY
Section 551.073 DELIBERATION REGARDING PROSPECTIVE GIFT
Section 551.074 PERSONNEL MATTERS
Section 551.076 DELIBERATION REGARDING SECURITY
Section 551.087 DELIBERATION REGARDING ECONOMIC DEVELOPMENT NEGOTIATIONS

Discussion on the following:

17. ***Discussion and action*** on advice received from City Attorney in closed session, and action to approve real estate transaction; authorize filing or settlement of legal action; authorize employment of expert witnesses and consultants, and employment of special counsel with respect to pending legal matters. ***Adriana Rodarte***

18. ***Discussion and action*** on qualifications of individuals for employment and for appointment to Boards & Commissions, job performance of employees, real estate acquisition and receive legal advice from City Attorney regarding legal issues affecting these matters. ***Adriana Rodarte***

19. ***Discussion and action*** regarding pending litigation and receive status report regarding pending litigation. ***Adriana Rodarte***

20. ***Discussion and action*** regarding personnel matters involving municipal courts under 551.071 and 551.074. ***Adriana Rodarte***

21. ***Ralph Duran v. City of Socorro, Texas, and International Eagle Enterprises, Inc. d/b/a Eagle Construction and/or Eagle Transportation***, in the 120th District Court of El Paso County, Texas, Cause No. 2020-DCV3246 [551.071]. ***James A. Martinez***

22. ***Adjourn***

DATED THIS 9th DAY OF NOVEMBER, 2020

By: 

Olivia Navarro, City Clerk

I, the undersigned authority, hereby certify that the above notice of the meeting of the City Council of Socorro, Texas is a correct copy of the notice and that I posted this notice at least Seventy-two (72) hours preceding the scheduled meeting at the City Administration Building, 124 S. Horizon Blvd., in Socorro, Texas.

DATED THIS 9TH DAY OF NOVEMBER, 2020

By: 

Olivia Navarro, City Clerk

Agenda posted: 11-9-2020 @ 1:15 pm
Removed: _____ Time: _____ by: _____

Elia Garcia
Mayor

Rene Rodriguez
At Large

Cesar Nevarez
District 1



Ralph Duran
District 2

Victor Perez
District 3/Mayor Pro Tem

Yvonne Colon-Villalobos
District 4

**REGULAR COUNCIL MEETING MINUTES
OCTOBER 15, 2020 @ 6:00 P.M.
VIRTUAL MEETING**

MEMBERS PRESENT:

Mayor Elia Garcia
Rene Rodriguez
Cesar Nevarez
Ralph Duran
Victor Perez
Yvonne Colon-Villalobos

STAFF PRESENT:

Adriana Rodarte, City Manager
Olivia Navarro, City Clerk
Jim Martinez (*joined virtually*)

Estevan Gonzales, IT Director
Michael Medina, City Planner
Mayela Granados, Executive Assistant

1. CALL TO ORDER

The meeting was called to order at: 6:10 p.m.

2. PLEDGE OF ALLEGIANCE AND A MOMENT OF SILENCE

Pledge of Allegiance was led by Adriana Rodarte.

3. ESTABLISHMENT OF QUORUM

A quorum was established with all members present.

4. PUBLIC COMMENT

Miriam Cruz spoke during Public Comment.

PRESENTATION

5. **PRESENTATION AND RECOGNITION TO 10 YEAR ANNIVERSARIES FOR CHRISTOPHER REY, JASIEL MUNOZ AND ISRAEL RODRIGUEZ.**

ADRIANA RODARTE

Presentation made by Adriana Rodarte.

Chief Burton, Rene Rodriguez, Ralph Duran, Victor Perez, Cesar Nevarez, Mayor Garcia, Lt. Christopher Rey, Sgt. Jasiel Muñoz and Corporal Israel Rodriguez spoke on this item.

6. **PRESENTATION ON THE CITY OF SOCORRO COMMUNITY INITIATIVE'S (CSCI) YEAR 1 ANNUAL REPORT TO CITY COUNCIL.**

ALEJANDRA VALADEZ

Presentation made by Alejandra Valadez

CONSENT AGENDA

7. **EXCUSE ABSENT COUNCIL MEMBERS.** **OLIVIA NAVARRO**

8. **APPROVAL OF REGULAR COUNCIL MEETING MINUTES OF OCTOBER 1, 2020.** **OLIVIA NAVARRO**

A motion was made by Victor Perez seconded by Rene Rodriguez to *approve the Consent Agenda*. Motion passed.

Ayes: Rene Rodriguez, Cesar Nevarez, Ralph Duran, Victor Perez and Yvonne Colon-Villalobos.

Nays:

Abstain:

REGULAR AGENDA

PUBLIC HEARING/ORDINANCES

9. **PUBLIC HEARING OF AN ORDINANCE AUTHORIZING THE ISSUANCE AND SALE OF CITY OF SOCORRO, TEXAS GENERAL OBLIGATION REFUNDING BONDS, SERIES 2020A; ESTABLISHING PROCEDURES AND DELEGATING AUTHORITY FOR THE SALE AND DELIVERY OF THE BONDS; LEVYING AN ANNUAL AD VALOREM TAX FOR THE PAYMENT OF SAID BONDS; PROVIDING AN EFFECTIVE DATE; AND ENACTING OTHER PROVISIONS RELATING TO THE SUBJECT.**

ADRIANA RODARTE

Public Hearing opened at 6:39 pm
No speakers for Public Hearing
Public Hearing closed at 6:40

10. SECOND READING AND ADOPTION OF AN ORDINANCE AUTHORIZING THE ISSUANCE AND SALE OF CITY OF SOCORRO, TEXAS GENERAL OBLIGATION REFUNDING BONDS, SERIES 2020A; ESTABLISHING PROCEDURES AND DELEGATING AUTHORITY FOR THE SALE AND DELIVERY OF THE BONDS; LEVYING AN ANNUAL AD VALOREM TAX FOR THE PAYMENT OF SAID BONDS; PROVIDING AN EFFECTIVE DATE; AND ENACTING OTHER PROVISIONS RELATING TO THE SUBJECT.
ADRIANA RODARTE

A motion was made by Rene Rodriguez seconded by Cesar Nevarez to *approve item number ten (10)*. Motion passed.

An amended motion was made by Rene Rodriguez seconded by Cesar Nevarez to *approve Amegy Bank*. Motion passed.

Miriam Cruz and Robert Tijerina spoke on this item.

Ayes: Rene Rodriguez, Cesar Nevarez, Ralph Duran, Victor Perez and Yvonne Colon-Villalobos.

Nays:

Abstain:

POLICE DEPARTMENT

11. DISCUSSION AND ACTION TO APPROVE AN AMENDMENT TO THE CITY OF SOCORRO RECRUIT POLICE OFFICER EMPLOYMENT CONTRACT.
CHIEF DAVID BURTON

Cesar Nevarez stepped out of the meeting at 6:55 pm

A motion was made by Rene Rodriguez seconded by Victor Perez to *approve item number eleven (11)*. Motion passed

Ayes: Rene Rodriguez, Ralph Duran, Victor Perez and Yvonne Colon-Villalobos.

Nays:

Absent: Cesar Nevarez

Cesar Nevarez stepped back to the meeting at 6:56 pm.

PLANNING AND ZONING DEPARTMENT

12. DISCUSSION AND ACTION ON THE FINAL PLAT APPROVAL FOR HUECO JUNCTION UNIT ONE BEING A PORTION OF TRACTS 12A, 12C, BLOCK 5, SOCORRO GRANT AND A REPLAT OF LOT 1, BLOCK 2, EASTLAKE VALLEY SUBDIVISION LOCATED AT THE INTERSECTION OF OLD HUECO TANKS ROAD AND NUEVO HUECO TANKS BLVD.

JOB TERRAZAS

A motion was made by Ralph Duran seconded by Cesar Nevarez to *approve item number twelve (12)*. Motion passed.

Ayes: Rene Rodriguez, Cesar Nevarez, Ralph Duran, Victor Perez and Yvonne Colon-Villalobos.

Nays:

Abstain:

CITY MANAGER

13. DISCUSSION AND ACTION TO APPROVE THE HIRING OF A PARKS AND PUBLIC WORKS DIRECTOR.

ADRIANA RODARTE

A motion was made by Victor Perez seconded by Cesar Nevarez to *approve item number thirteen (13)*. Motion passed.

Ayes: Rene Rodriguez, Cesar Nevarez, Ralph Duran, Victor Perez and Yvonne Colon-Villalobos.

Nays:

Abstain:

14. DISCUSSION AND ACTION ON APPROVING JOB DESCRIPTION FOR FOREMAN.

ADRIANA RODARTE

A motion was made by Victor Perez seconded by Cesar Nevarez to *approve item number fourteen (14)*. Motion passed.

Ayes: Rene Rodriguez, Cesar Nevarez, Ralph Duran, Victor Perez and Yvonne Colon-Villalobos.

Nays:

Abstain:

15. DISCUSSION AND ACTION ON ADVICE RECEIVED FROM CITY ATTORNEY IN CLOSED SESSION, AND ACTION TO APPROVE REAL ESTATE TRANSACTION; AUTHORIZE FILING OR SETTLEMENT OF LEGAL ACTION; AUTHORIZE EMPLOYMENT OF EXPERT WITNESSES AND CONSULTANTS, AND EMPLOYMENT OF SPECIAL COUNSEL WITH RESPECT TO PENDING LEGAL MATTERS. *ADRIANA RODARTE*

16. DISCUSSION AND ACTION ON QUALIFICATIONS OF INDIVIDUALS FOR EMPLOYMENT AND FOR APPOINTMENT TO BOARDS & COMMISSIONS, JOB PERFORMANCE OF EMPLOYEES, REAL ESTATE ACQUISITION AND RECEIVE LEGAL ADVICE FROM CITY ATTORNEY REGARDING LEGAL ISSUES AFFECTING THESE MATTERS. *ADRIANA RODARTE*

17. DISCUSSION AND ACTION REGARDING PENDING LITIGATION AND RECEIVE STATUS REPORT REGARDING PENDING LITIGATION. *ADRIANA RODARTE*

A motion was made by Victor Perez seconded by Cesar Nevarez to *delete items fifteen (15), sixteen (16) and seventeen (17)*. Motion passed.

Ayes: Rene Rodriguez, Cesar Nevarez, Ralph Duran, Victor Perez and Yvonne Colon-Villalobos.

Nays:

Abstain:

A motion was made by Victor Perez seconded by Rene Rodriguez to *move into Executive Session at this time*. Motion passed.

Ayes: Rene Rodriguez, Cesar Nevarez, Ralph Duran, Victor Perez and Yvonne Colon-Villalobos.

Nays:

Abstain:

THE CITY COUNCIL CONVENED INTO EXECUTIVE SESSION AT 7:18 PM

EXECUTIVE SESSION

THE CITY COUNCIL RECONVENED IN OPEN SESSION AT 8:01 PM

11. DISCUSSION AND ACTION REGARDING PERSONNEL MATTERS INVOLVING MUNICIPAL COURTS UNDER 551.071 AND 551.074. *ADRIANA RODARTE*

A motion was made by Victor Perez seconded by Rene Rodriguez to *address issue regarding municipal court for next Regular Meeting for possible censure of that individual.* Motion passed.

Ayes: Rene Rodriguez, Cesar Nevarez, Victor Perez and Yvonne Colon-Villalobos
Nays: Ralph Duran
Abstain:

12. DISCUSSION AND ACTION ON THE AUTHORIZATION FOR THE ACQUISITION OF PROPERTIES RELATED TO THE NORTH NEVAREZ ROADWAY PROJECT. MICHAEL MEDINA

A motion was made by Rene Rodriguez seconded by Cesar Nevarez to *approve Mr. Perez's recommendation as discussed in executive session.* Motion passed.

Ayes: Rene Rodriguez, Cesar Nevarez, Ralph Duran, Victor Perez and Yvonne Colon-Villalobos.
Nays:
Abstain:

18. ADJOURN

A motion was made by Victor Perez seconded by Ralph Duran to *adjourn at 8:04 pm.* Motion passed.

Ayes: Rene Rodriguez, Cesar Nevarez, Ralph Duran, Victor Perez and Yvonne Colon-Villalobos.
Nays:
Abstain:

Elia Garcia, Mayor

Olivia Navarro, City Clerk

Date minutes were approved

Elia Garcia
Mayor

Rene Rodriguez
At Large

Cesar Nevarez
District 1



Ralph Duran
District 2

Victor Perez
District 3/Mayor Pro Tem

Yvonne Colon-Villalobos
District 4

**SPECIAL COUNCIL MEETING MINUTES
OCTOBER 19, 2020 @ 6:00 P.M.
VIRTUAL MEETING**

MEMBERS PRESENT:

Mayor Elia Garcia
Rene Rodriguez
Cesar Nevarez
Ralph Duran
Yvonne Colon-Villalobos

MEMBERS ABSENT:

Victor Perez

STAFF PRESENT:

Adriana Rodarte, City Manager
Olivia Navarro, City Clerk
Jim Martinez (*joined virtually*)

Estevan Gonzales, IT Director
Mayela Granados, Executive Assistant

1. CALL TO ORDER

The meeting was called to order at: 6:13 p.m.

2. PLEDGE OF ALLEGIANCE AND A MOMENT OF SILENCE

Pledge of Allegiance was led by Adriana Rodarte.

3. ESTABLISHMENT OF QUORUM

A quorum was established with five members present.

4. PUBLIC COMMENT

Miriam Cruz and Jesse Montelongo spoke during Public Comment.

CONSENT AGENDA

5. EXCUSE ABSENT COUNCIL MEMBERS.

OLIVIA NAVARRO

A motion was made by Ralph Duran seconded by Rene Rodriguez to *approve Consent Agenda*. Motion passed.

Cesar Nevarez stepped out of the meeting at 6:18 pm

Ayes: Rene Rodriguez, Ralph Duran and Yvonne Colon-Villalobos

Nays:

Absent: Cesar Nevarez and Victor Perez

Cesar Nevarez stepped back into the meeting at 6:19 pm

REGULAR AGENDA

6. DISCUSSION AND ACTION REGARDING MONITORING OF AND IMPLEMENTATION OF PRECAUTIONARY MEASURES IN AND NEAR POLLING PLACES IN LIGHT OF AN INCREASE IN COVID-19 CASES.

RENE RODRIGUEZ

A motion was made by Cesar Nevarez seconded by Rene Rodriguez to *approve item number six (6)*.

A motion was made by Rene Rodriguez seconded by Ralph Duran to *move into Executive Session at this time*. Motion passed.

Ayes: Rene Rodriguez, Cesar Nevarez, Ralph Duran and Yvonne Colon Villalobos

Nays:

Absent: Victor Perez

THE CITY COUNCIL CONVENED INTO EXECUTIVE SESSION AT 6:25 PM

EXECUTIVE SESSION

THE CITY COUNCIL RECONVENED IN OPEN SESSION AT 6:57 PM

An amended motion was made by Cesar Nevarez seconded by Rene Rodriguez to *delete item number six (6)*. Motion passed.

Miriam Cruz and Jesse Montelongo spoke on this item.

Ayes: Rene Rodriguez, Cesar Nevarez, Ralph Duran and Yvonne Colon Villalobos

Nays:

Absent: Victor Perez

7. **DISCUSSION AND ACTION ON ADVICE RECEIVED FROM CITY ATTORNEY IN CLOSED SESSION, AND ACTION TO APPROVE REAL ESTATE TRANSACTION; AUTHORIZE FILING OR SETTLEMENT OF LEGAL ACTION; AUTHORIZE EMPLOYMENT OF EXPERT WITNESSES AND CONSULTANTS, AND EMPLOYMENT OF SPECIAL COUNSEL WITH RESPECT TO PENDING LEGAL MATTERS. ADRIANA RODARTE**

8. **DISCUSSION AND ACTION ON QUALIFICATIONS OF INDIVIDUALS FOR EMPLOYMENT AND FOR APPOINTMENT TO BOARDS & COMMISSIONS, JOB PERFORMANCE OF EMPLOYEES, REAL ESTATE ACQUISITION AND RECEIVE LEGAL ADVICE FROM CITY ATTORNEY REGARDING LEGAL ISSUES AFFECTING THESE MATTERS. ADRIANA RODARTE**

9. **DISCUSSION AND ACTION REGARDING PENDING LITIGATION AND RECEIVE STATUS REPORT REGARDING PENDING LITIGATION. ADRIANA RODARTE**

A motion was made by Ralph Duran seconded by Rene Rodriguez to *delete items seven (7), eight (8) and nine (9)*. Motion passed.

Ayes: Rene Rodriguez, Cesar Nevarez, Ralph Duran and Yvonne Colon Villalobos

Nays:

Absent: Victor Perez

10. **ADJOURN**

A motion was made by Ralph Duran seconded by Cesar Nevarez to *adjourn at 7:02 pm*. Motion passed.

Ayes: Rene Rodriguez, Cesar Nevarez, Ralph Duran and Yvonne Colon Villalobos

Nays:

Absent: Victor Perez

Elia Garcia, Mayor

Olivia Navarro, City Clerk

Date minutes were approved

Elia Garcia
Mayor
Rene Rodriguez
At Large
Cesar Nevarez
District 1 / Mayor Pro Tem



Ralph Duran
District 2
Victor Perez
District 3
Yvonne Colon-Villalobos
District 4
Adriana Rodarte
City Manager

DATE: October 29, 2020

TO: MAYOR AND CITY COUNCIL MEMBERS

FROM: Charles Casiano, Finance Director

SUBJECT: Discussion and action on approving September 2020 accounts payable report.

SUMMARY

The accounts payable report summarizes all of the checks which have been issued for September 2020. This report does not include any accruals entered as journal entries or any cash disbursements for credit card purchases.

STATEMENT OF THE ISSUE

FINANCIAL IMPACT

ALTERNATIVE

STAFF RECOMMENDATION

City of Socorro
Accounts Payable
for September 2020

Date	Name	Transaction Description	Code	GL Description	Amount	Department	Fund
9/1/2020	AFLAC	AFLACE4810 BILLING PERIOD AUG 2020	02005	AFLAC Sup Ins. Withheld (Emp)	98.64	Municipal Court	GENERAL FUND
9/1/2020	AFLAC	AFLACE4810 BILLING PERIOD AUG 2020	02005	AFLAC Sup Ins. Withheld (Emp)	281.88	Planning and Zoning	GENERAL FUND
9/1/2020	AFLAC	AFLACE4810 BILLING PERIOD AUG 2020	02005	AFLAC Sup Ins. Withheld (Emp)	1,760.90	Police Department	GENERAL FUND
9/1/2020	AFLAC	AFLACE4810 BILLING PERIOD AUG 2020	02005	AFLAC Sup Ins. Withheld (Emp)	728.28	Public Works	GENERAL FUND
9/1/2020	AFLAC	AFLACE4810 BILLING PERIOD AUG 2020	02005	AFLAC Sup Ins. Withheld (Emp)	318.60	Recreation Centers	GENERAL FUND
9/1/2020	AFLAC	AFLACE4810 BILLING PERIOD AUG 2020	02005	AFLAC Sup Ins. Withheld (Emp)	33.12	Mayor and City Council	GENERAL FUND
9/1/2020	AFLAC	AFLAC E4810 Billing Period: SEP 2020	02005	AFLAC Sup Ins. Withheld (Emp)	404.28	City Manager	GENERAL FUND
9/1/2020	AFLAC	AFLAC E4810 Billing Period: SEP 2020	02005	AFLAC Sup Ins. Withheld (Emp)	68.64	Finance Department	GENERAL FUND
9/1/2020	AFLAC	AFLAC E4810 Billing Period: SEP 2020	02005	AFLAC Sup Ins. Withheld (Emp)	149.22	Information Technology	GENERAL FUND
9/1/2020	AFLAC	AFLAC E4810 Billing Period: SEP 2020	02005	AFLAC Sup Ins. Withheld (Emp)	98.64	Municipal Court	GENERAL FUND
9/1/2020	AFLAC	AFLAC E4810 Billing Period: SEP 2020	02005	AFLAC Sup Ins. Withheld (Emp)	281.88	Planning and Zoning	GENERAL FUND
9/1/2020	AFLAC	AFLAC E4810 Billing Period: SEP 2020	02005	AFLAC Sup Ins. Withheld (Emp)	1,830.98	Police Department	GENERAL FUND
9/1/2020	AFLAC	AFLAC E4810 Billing Period: SEP 2020	02005	AFLAC Sup Ins. Withheld (Emp)	728.28	Public Works	GENERAL FUND
9/1/2020	AFLAC	AFLAC E4810 Billing Period: SEP 2020	02005	AFLAC Sup Ins. Withheld (Emp)	318.60	Recreation Centers	GENERAL FUND
9/1/2020	AFLAC	AFLAC E4810 Billing Period: SEP 2020	02005	AFLAC Sup Ins. Withheld (Emp)	33.12	Mayor and City Council	GENERAL FUND
9/10/2020	AFSCME Local 59	AFSCME LOCAL 59-EMPLOYEE LIST ATTACHED PPE 9/5/2020	02608	Local 59-AFL-CIO	119.00	Public Works	GENERAL FUND
9/24/2020	AFSCME Local 59	AFSCME LOCAL 59-EMPLOYEE LIST ATTACHED PPE 9/19/2020	02608	Local 59-AFL-CIO	119.00	Public Works	GENERAL FUND
9/4/2020	Anchor Mobile Home Service LLC	Modular Building	07502	Building and Facilities	49,749.00	Police Department	CARES ACT FUND
9/29/2020	APACHE BARRICADE & SIGNS	PO99903-TMA RENTAL-ALAMEDA/BOVEE	05312	Street Maintenance	500.00	Public Works	GENERAL FUND
9/25/2020	Armando Alegre	PO99907-PLUMBING INSPECTIONS 9/21-25/2020	05520	Service Contracts	2,926.00	Planning and Zoning	GENERAL FUND
9/18/2020	Armando Alegre	PO99907-PLUMBING INSPECTIONS 9/14-18/2020	05520	Service Contracts	3,652.00	Planning and Zoning	GENERAL FUND
9/4/2020	Armando Alegre	PO99907-PLUMBING INSPECTIONS 8/31-9/4/2020	05520	Service Contracts	2,343.00	Planning and Zoning	GENERAL FUND
9/11/2020	Armando Alegre	PO99907-PLUMBING INSPECTIONS 9/8-9/11/2020	05520	Service Contracts	2,596.00	Planning and Zoning	GENERAL FUND
9/7/2020	AT & T	LAND LINE TELEPHONE SVC. FROM 09/07/10/06/2020	05314	Telephone	149.88	City Manager	GENERAL FUND
9/7/2020	AT & T	LAND LINE TELEPHONE SVC. FROM 09/07/10/06/2020	05314	Telephone	1,683.21	Police Department	GENERAL FUND
9/7/2020	AT & T	LAND LINE TELEPHONE SVC. FROM 09/07/10/06/2020	05314	Telephone	164.99	Municipal Court	GENERAL FUND

Date	Name	Transaction Description	Code	GL Description	Amount	Department	Fund
9/7/2020	AT & T	LAND LINE TELEPHONE SVC. FROM 09/07/10/06/2020	05314	Telephone	199.92	Planning and Zoning	GENERAL FUND
9/22/2020	AT&T Mobility	PD WIRELESS SVC-8/15-9/14/2020	05314	Telephone	91.60	Police Department	GENERAL FUND
9/1/2020	Blue Cross Blue Shield of TX	HEALTH.INS.ACCT#000111535-0000171773- SEPT 2020	05113	Health Insurance Premiums	1,045.44	Information Technology	GENERAL FUND
9/1/2020	Blue Cross Blue Shield of TX	HEALTH.INS.ACCT#000111535-0000171773- SEPT 2020	05113	Health Insurance Premiums	2,594.56	Recreation Centers	GENERAL FUND
9/1/2020	Blue Cross Blue Shield of TX	HEALTH.INS.ACCT#000111535-0000171773- SEPT 2020	05113	Health Insurance Premiums	3,029.92	Finance Department	GENERAL FUND
9/1/2020	Blue Cross Blue Shield of TX	HEALTH.INS.ACCT#000111535-0000171773- SEPT 2020	05113	Health Insurance Premiums	648.64	City Clerk	GENERAL FUND
9/1/2020	Blue Cross Blue Shield of TX	HEALTH.INS.ACCT#000111535-0000171773- SEPT 2020	05113	Health Insurance Premiums	2,594.56	Mayor and City Council	GENERAL FUND
9/1/2020	Blue Cross Blue Shield of TX	HEALTH.INS.ACCT#000111535-0000171773- SEPT 2020	05113	Health Insurance Premiums	1,045.44	Grants and Special Projects	GENERAL FUND
9/1/2020	Blue Cross Blue Shield of TX	HEALTH.INS.ACCT#000111535-0000171773- SEPT 2020	05113	Health Insurance Premiums	5,059.41	Planning and Zoning	GENERAL FUND
9/1/2020	Blue Cross Blue Shield of TX	HEALTH.INS.ACCT#000111535-0000171773- SEPT 2020	05113	Health Insurance Premiums	2,594.56	Municipal Court	GENERAL FUND
9/1/2020	Blue Cross Blue Shield of TX	HEALTH.INS.ACCT#000111535-0000171773- SEPT 2020	05113	Health Insurance Premiums	37,430.27	Police Department	GENERAL FUND
9/1/2020	Blue Cross Blue Shield of TX	HEALTH.INS.ACCT#000111535-0000171773- SEPT 2020	05113	Health Insurance Premiums	14,918.72	Public Works	GENERAL FUND
9/1/2020	Blue Cross Blue Shield of TX	HEALTH.INS.ACCT#000111535-0000171773- SEPT 2020	05113	Health Insurance Premiums	5,708.05	City Manager	GENERAL FUND
9/1/2020	Brunson Pump Service	PO99903-HC/REG PORTABLE TOILET RENTAL-MOON CTY PK-SEP 2020	05520	Service Contracts	187.00	Public Works	GENERAL FUND
9/1/2020	Brunson Pump Service	PO99903-PORTABLE TOILET RENTAL VALLE DL SOL PK SEP 2020	05520	Service Contracts	109.70	Public Works	GENERAL FUND
9/1/2020	Brunson Pump Service	PO99903-PORTABLE RENTAL SEP 2020- PARADISE PK	05520	Service Contracts	154.60	Public Works	GENERAL FUND
9/25/2020	Budagher Generator, Inc.	Equipment Purchases - Sp Rev.	05810	Property and Equipment	15,500.00	Police Department	SPECIAL REVENUES FUND
9/28/2020	Cintas Corporation No. 2	PO99903/99902-UNIFORM SVCS	05213	Uniforms	256.31	Public Works	GENERAL FUND
9/28/2020	Cintas Corporation No. 2	PO99903/99902-UNIFORM SVCS	05213	Uniforms	55.37	City Manager	GENERAL FUND
9/21/2020	Cintas Corporation No. 2	PO99903/99902-UNIFORM SVCS	05213	Uniforms	256.31	Public Works	GENERAL FUND
9/21/2020	Cintas Corporation No. 2	PO99903/99902-UNIFORM SVCS	05213	Uniforms	55.37	City Manager	GENERAL FUND
9/8/2020	Cintas Corporation No. 2	PO99903/99902-UNIFORM SVCS	05213	Uniforms	204.93	Public Works	GENERAL FUND

Date	Name	Transaction Description	Code	GL Description	Amount	Department	Fund
9/8/2020	Cintas Corporation No. 2	PO99903/99902-UNIFORM SVCS	05213	Uniforms	209.25	City Manager	GENERAL FUND
9/14/2020	Cintas Corporation No. 2	PO99903/99902-UNIFORM SVCS	05213	Uniforms	220.87	Public Works	GENERAL FUND
9/14/2020	Cintas Corporation No. 2	PO99903/99902-UNIFORM SVCS	05213	Uniforms	55.37	City Manager	GENERAL FUND
9/30/2020	CITY OF EL PASO	SEPTEMBER 2020	05525	Health/Ambulance Contract	4,890.00	Health Department	GENERAL FUND
9/24/2020	CLEAT ADMIN. OFC.	CLEAT DUES EMPLOYEE LIST ATTACHED PPE 9/19/2020	02604	Cleat Dues	180.05	Police Department	GENERAL FUND
9/10/2020	CLEAT ADMIN. OFC.	CLEAT DUES EMPLOYEE LIST ATTACHED PPE 9/5/2020	02604	Cleat Dues	180.05	Police Department	GENERAL FUND
9/18/2020	Concentra Medical Centers	PO99912-INJURY CARE/POST ACCIDENT DRUG TEST-I. HERNANDEZ	05511	Advertising/Drug Testing	109.50	Human Resources	GENERAL FUND
9/1/2020	David De La Riva	Modular Bldg Site	07502	Building and Facilities	14,937.50	Capital Projects Fund	CAPITAL PROJECTS 2019 CO's
9/1/2020	Delgado Acosta et al LLP	Collection Fees MC	02617	Collection Agency COLL	6,556.14	Municipal Court	GENERAL FUND
9/3/2020	Don Chalmers Ford Inc.	Equipment Purchases	05810	Property and Equipment	43,706.01	Police Department	GENERAL FUND
9/3/2020	Don Chalmers Ford Inc.	Equipment Purchases	05810	Property and Equipment	14,472.67	Police Department	GENERAL FUND
9/1/2020	El Paso Central Appraisal	PO25247-APPRAISAL SVC, FY 20/21 1ST QTR DUE BEFORE 9/30/20	05513	Central Appraisal Fees	27,961.18	Finance Department	GENERAL FUND
9/1/2020	El Paso Disposal	Monthly svc-241 Old Hueco Tanks Rd SEP 2020	05311	Building & Property Maintenanc	50.00	Public Works	GENERAL FUND
9/30/2020	El Paso Disposal	PO99903-DISP. SVC ROLLOFF CONT. 241HuecoTanks-SEP 2020	05520	Service Contracts	970.14	Public Works	GENERAL FUND
9/14/2020	El Paso Electric Company	Electric Services Sept 2020	05313	Utilities	113.41	Public Works	GENERAL FUND
9/14/2020	El Paso Electric Company	Electric Services Sept 2020	05313	Utilities	17,854.60	Public Works	GENERAL FUND
9/14/2020	El Paso Electric Company	Electric Services Sept 2020	05313	Utilities	2,849.59	Police Department	GENERAL FUND
9/14/2020	El Paso Electric Company	Electric Services Sept 2020	05313	Utilities	579.18	Police Department	GENERAL FUND
9/12/2020	El Paso Times, Inc.	PO99914-PUBLIC HEARING NOTICE	05511	Advertising/Drug Testing	296.84	City Clerk	GENERAL FUND
9/13/2020	El Paso Times, Inc.	PO99914-STATE LOBBYING SVCS AD-20-01	05511	Advertising/Drug Testing	1,750.80	City Clerk	GENERAL FUND
9/13/2020	El Paso Times, Inc.	PO99914-COS SIDEWALK PRJ PH1 AD 20-01	05511	Advertising/Drug Testing	2,203.56	City Clerk	GENERAL FUND
9/5/2020	El Paso Times, Inc.	PO99914-PUBLIC HEARING NOTICE	05511	Advertising/Drug Testing	520.56	City Clerk	GENERAL FUND
9/1/2020	El Paso Times, Inc.	PO99914-ADOPTION OF ORDINANCES	05511	Advertising/Drug Testing	206.40	City Clerk	GENERAL FUND
9/1/2020	El Paso Times, Inc.	PO99914-PUBLIC HEARING NOTICE	05511	Advertising/Drug Testing	196.88	City Clerk	GENERAL FUND
9/1/2020	El Paso Times, Inc.	PO99914-ADOPTION OF ORDINANCE AD	05511	Advertising/Drug Testing	301.60	City Clerk	GENERAL FUND
9/1/2020	El Paso Times, Inc.	PO99914-PUBLIC NOTCE AD	05511	Advertising/Drug Testing	301.60	City Clerk	GENERAL FUND
9/23/2020	El Paso Times, Inc.	PO99914-PUBLIC HEARING AD	05511	Advertising/Drug Testing	330.16	City Clerk	GENERAL FUND

Date	Name	Transaction Description	Code	GL Description	Amount	Department	Fund
9/21/2020	El Paso Times, Inc.	PO99902-SUBSCRIPTION-DELIVERY SVC RATE INCREASE	05516	Dues/Subscriptions	7.29	City Manager	GENERAL FUND
9/15/2020	El Paso Times, Inc.	PO99914-ADOPTION OF ORDINANCE AD	05511	Advertising/Drug Testing	277.80	City Clerk	GENERAL FUND
9/30/2020	Elite Medical Transport	AMBULANCE SVCS CONTRACT	05525	Health/Ambulance Contract	27,500.00	Fire and Ambulance	GENERAL FUND
9/1/2020	Elite Medical Transport	AMBULANCE SVCS CONTRACT	05525	Health/Ambulance Contract	27,500.00	Fire and Ambulance	GENERAL FUND
9/1/2020	First Check	PO99912-STANDARD BACKGROUND-VARIOUS NEW EMPLOYEES-HR	05511	Advertising/Drug Testing	61.00	Human Resources	GENERAL FUND
9/1/2020	Flex Enterprises, LLC	PO99912-CORP WELLNESS-VARIOUS EMPLOYEES-HR	02623	EP FITNESS Withholding	259.68		GENERAL FUND
9/30/2020	Fusion Cloud Services, LLC	LD Telephone svc - SEP 2020	05314	Telephone	89.78	Police Department	GENERAL FUND
9/30/2020	Fusion Cloud Services, LLC	LD Telephone svc - SEP 2020	05314	Telephone	31.18	City Manager	GENERAL FUND
9/30/2020	Fusion LLC	PO25274-INTERNET/PHONE SVCS FOR ALL DEPTS-SEP 2020	05314	Telephone	75.94	City Manager	GENERAL FUND
9/30/2020	Fusion LLC	PO25274-INTERNET/PHONE SVCS FOR ALL DEPTS-SEP 2020	05314	Telephone	94.60	Municipal Court	GENERAL FUND
9/30/2020	Fusion LLC	PO25274-INTERNET/PHONE SVCS FOR ALL DEPTS-SEP 2020	05314	Telephone	59.98	Police Department	GENERAL FUND
9/30/2020	Fusion LLC	PO25274-INTERNET/PHONE SVCS FOR ALL DEPTS-SEP 2020	05314	Telephone	119.38	Police Department	GENERAL FUND
9/30/2020	Fusion LLC	PO25274-INTERNET/PHONE SVCS FOR ALL DEPTS-SEP 2020	05314	Telephone	94.59	Planning and Zoning	GENERAL FUND
9/30/2020	Fusion LLC	PO25274-INTERNET/PHONE SVCS FOR ALL DEPTS-SEP 2020	05314	Telephone	62.52	Recreation Centers	GENERAL FUND
9/30/2020	Fusion LLC	PO25274-INTERNET/PHONE SVCS FOR ALL DEPTS-SEP 2020	05314	Telephone	987.00	Recreation Centers	GENERAL FUND
9/30/2020	Fusion LLC	PO25274-INTERNET/PHONE SVCS FOR ALL DEPTS-SEP 2020	05314	Telephone	2,401.23	City Manager	GENERAL FUND
9/30/2020	Fusion LLC	PO25274-INTERNET/PHONE SVCS FOR ALL DEPTS-SEP 2020	05314	Telephone	406.57	Municipal Court	GENERAL FUND
9/30/2020	Fusion LLC	PO25274-INTERNET/PHONE SVCS FOR ALL DEPTS-SEP 2020	05313	Utilities	260.25	Police Department	GENERAL FUND
9/30/2020	Fusion LLC	PO25274-INTERNET/PHONE SVCS FOR ALL DEPTS-SEP 2020	05314	Telephone	2,490.75	Police Department	GENERAL FUND
9/30/2020	Fusion LLC	PO25274-INTERNET/PHONE SVCS FOR ALL DEPTS-SEP 2020	05314	Telephone	1,214.63	Police Department	GENERAL FUND
9/30/2020	Fusion LLC	PO25274-INTERNET/PHONE SVCS FOR ALL DEPTS-SEP 2020	05314	Telephone	406.57	Police Department	GENERAL FUND
9/30/2020	Fusion LLC	PO25274-INTERNET/PHONE SVCS FOR ALL DEPTS-SEP 2020	05314	Telephone	260.25	Police Department	GENERAL FUND

Date	Name	Transaction Description	Code	GL Description	Amount	Department	Fund
9/30/2020	Fusion LLC	PO25274-INTERNET/PHONE SVCS FOR ALL DEPTS-SEP 2020	05313	Utilities	987.00	Public Works	GENERAL FUND
9/30/2020	Fusion LLC	PO25274-INTERNET/PHONE SVCS FOR ALL DEPTS-SEP 2020	05314	Telephone	406.56	Planning and Zoning	GENERAL FUND
9/30/2020	Fusion LLC	PO25274-INTERNET/PHONE SVCS FOR ALL DEPTS-SEP 2020	05314	Telephone	993.71	Recreation Centers	GENERAL FUND
9/1/2020	I.C. System, Inc.	PO99902-SETTLEMENT - ATT LANDLINE 915-858-8802-200	05314	Telephone		City Manager	GENERAL FUND
9/1/2020	I.C. System, Inc.	PO99902-SETTLEMENT - ATT LANDLINE 915-858-8802-200	05314	Telephone	520.00	City Manager	GENERAL FUND
9/1/2020	Interlease	PO99916-COPYLEAS-KK6203-SVN/MPC305SPF-W794P103725 RVCC-SEP20	05523	Equipment Rental/Lease	135.32	Recreation Centers	GENERAL FUND
9/1/2020	Interlease	Contract Lease for Copier	05523	Equipment Rental/Lease	189.00	City Manager	GENERAL FUND
9/1/2020	Interlease	Equipment Rental	05523	Equipment Rental/Lease	358.00	Planning and Zoning	GENERAL FUND
9/1/2020	Interlease	PO99903-CONTRACT BASE RATE CHARGE SEP 2020	05523	Equipment Rental/Lease	85.54	Public Works	GENERAL FUND
9/24/2020	J & L Glass	PO99902-PLEXI GLASS-COVID19	05311	Building & Property Maintenanc	970.00	City Manager	CARES ACT FUND
9/24/2020	J & L Glass	PO99902-PLEXI GLASS-COVID19	05311	Building & Property Maintenanc	975.00	City Manager	CARES ACT FUND
9/24/2020	J & L Glass	PO99916-WINDOW REPLACEMENT-CACC	05311	Building & Property Maintenanc	540.00	Recreation Centers	GENERAL FUND
9/24/2020	Jacob Gomez	Settlement	08000	Settlements		Police Department	GENERAL FUND
9/16/2020	JC's Custom Shutters Inc	Building & Property Maintenanc	05810	Property and Equipment	2,570.32	Municipal Court	GENERAL FUND
9/16/2020	JC's Custom Shutters Inc	PO25204-SHUTTERS COMPLETED 9/16/2020	05810	Property and Equipment	730.45	Municipal Court	GENERAL FUND
9/28/2020	Jimmy Dominguez	PO99905-FUEL REIMB-BASIC SWAT TRNG-OFC J.DOMINGUEZ 9/28-10/2	05711	Travel Lodg Airf Mil	20.44	Police Department	GENERAL FUND
9/27/2020	Jimmy Dominguez	PO99905-PERDIEM-BASIC SWAT TRNG-OFC J.DOMINGUEZ 9/28-10/2/20	05711	Travel Lodg Airf Mil	308.00	Police Department	GENERAL FUND
9/29/2020	Jobe Materials, L.P.	Street Maintenance	05312	Street Maintenance	246.14	Public Works	GENERAL FUND
9/24/2020	Jobe Materials, L.P.	Street Maintenance	05312	Street Maintenance	253.58	Public Works	GENERAL FUND
9/1/2020	Jobe Materials, L.P.	Street Maintenance	05312	Street Maintenance	28,667.14	Capital Projects Fund	CAPITAL PROJECTS 2019 CO's
9/1/2020	Jobe Materials, L.P.	Street Maintenance	05312	Street Maintenance	1,620.06	Public Works	GENERAL FUND
9/2/2020	Jobe Materials, L.P.	Street Maintenance	05312	Street Maintenance	48,630.69	Capital Projects Fund	CAPITAL PROJECTS 2019 CO's
9/5/2020	Julio Cesar Huerta	PO99905-TOWING SVC-'20 CHEVY P/U	05520	Service Contracts	150.00	Police Department	GENERAL FUND
9/1/2020	Kaufman's West, LLC	PO99905-UNIFORM PATCHES	05213	Uniforms	156.00	Police Department	GENERAL FUND
9/1/2020	Kaufman's West, LLC	PO99905-UNIFORMS PANTS-CASTANEDA	05213	Uniforms	100.40	Police Department	GENERAL FUND

Date	Name	Transaction Description	Code	GL Description	Amount	Department	Fund
9/1/2020	Kaufman's West, LLC	PO99905-UNIFORM PANTS-ACEVEDO	05213	Uniforms	120.38	Police Department	GENERAL FUND
9/1/2020	Kaufman's West, LLC	PO99905-UNIFORM PANTS & ALTERATIONS-ESPARZA,SMITH	05213	Uniforms	236.76	Police Department	GENERAL FUND
9/1/2020	Kaufman's West, LLC	PO24619-UNIFORM PANS & ALTERATIONS-BENAVIDEZ,ROBERSON	05213	Uniforms	236.76	Police Department	GENERAL FUND
9/1/2020	Kaufman's West, LLC	PO24619-ERT UNIFORMS	05213	Uniforms	882.00	Police Department	GENERAL FUND
9/1/2020	Kaufman's West, LLC	PO24619-UNIFORM PATCHES	05213	Uniforms	609.00	Police Department	GENERAL FUND
9/1/2020	Kaufman's West, LLC	PO99905-UNIFORM PATCHES	05213	Uniforms	596.00	Police Department	GENERAL FUND
9/1/2020	Keila A. Reyes	PO99914-TRANSLATION SVCS-COS ORDINANCE CHARTR ELECTNS 2020	05520	Service Contracts	1,002.56	City Clerk	GENERAL FUND
9/11/2020	Laun-Dry Supply Company, Inc.	PO99907-DISPENSER/AEROSOL DEODORANTS,TOWEL ROLLS	05201	Office Expense and Supplies	495.16	Planning and Zoning	GENERAL FUND
9/28/2020	Lopez, James M.	Aquarium Maintenance/Supplies	05311	Building & Property Maintenanc	460.00	City Manager	GENERAL FUND
9/30/2020	Lower Valley Water District	WATER SVCS @317 MOON RD. ACCT# 60503001 SEP 2020	05313	Utilities	29.25	City Manager	GENERAL FUND
9/30/2020	Lower Valley Water District	WATER SVC-908 CPL ANGEL MONAREZ PARK SEP 2020	05313	Utilities	30.36	Public Works	GENERAL FUND
9/16/2020	Lower Valley Water District	Water svc- 851 Rio Vista-8/17-9/16/2020	05313	Utilities	40.66	Planning and Zoning	GENERAL FUND
9/16/2020	Lower Valley Water District	Water/Disposal services - Rio Vista Farm-8/17-9/16/2020	05313	Utilities	70.52	Recreation Centers	GENERAL FUND
9/16/2020	Lower Valley Water District	Water/Disposal services - Rio Vista Farm-8/17-9/16/2020	05311	Building & Property Maintenanc	85.00	Recreation Centers	GENERAL FUND
9/11/2020	Lower Valley Water District	Water/Disposal svcs - 10200 Calucutta Dr. 8/12-9/11/2020	05313	Utilities	59.12	Police Department	GENERAL FUND
9/11/2020	Lower Valley Water District	Water/Disposal svcs - 10200 Calucutta Dr. 8/12-9/11/2020	05311	Building & Property Maintenanc	58.00	Police Department	GENERAL FUND
9/14/2020	Lower Valley Water District	WATER SVC 800 RIO VISTA RD. ACCT 40364102 - 8/13-9/14/2020	05313	Utilities	61.74	Police Department	GENERAL FUND
9/14/2020	Lower Valley Water District	WATER SVC 800 RIO VISTA RD. ACCT 40364102 - 8/13-9/14/2020	05311	Building & Property Maintenanc	58.00	Police Department	GENERAL FUND
9/10/2020	Lower Valley Water District	Water/Disposal svcs-341 N. MOON RD-8/11-9/10/2020	05313	Utilities	628.87	Recreation Centers	GENERAL FUND
9/10/2020	Lower Valley Water District	Water/Disposal svcs-341 N. MOON RD-8/11-9/10/2020	05311	Building & Property Maintenanc	17.35	Recreation Centers	GENERAL FUND
9/10/2020	Lower Valley Water District	WATER/DISPOSAL SVCS@241 MOON RD. 8/11-9/10/2020	05313	Utilities	242.27	Public Works	GENERAL FUND
9/10/2020	Lower Valley Water District	WATER/DISPOSAL SVCS@241 MOON RD. 8/11-9/10/2020	05311	Building & Property Maintenanc	35.35	Public Works	GENERAL FUND

Date	Name	Transaction Description	Code	GL Description	Amount	Department	Fund
9/9/2020	Lower Valley Water District	Water Svc-Landscape 423 Horizon Blvd 8/10-9/9/2020	05313	Utilities	29.25	Public Works	GENERAL FUND
9/9/2020	Lower Valley Water District	Water/Disposal svcs- 124 S.Horizon Blvd-8/10-9/9/2020	05311	Building & Property Maintenanc	58.00	City Manager	GENERAL FUND
9/9/2020	Lower Valley Water District	Water/Disposal svcs- 124 S.Horizon Blvd-8/10-9/9/2020	05313	Utilities	68.09	City Manager	GENERAL FUND
9/9/2020	Lower Valley Water District	Water/Disposal svcs- 124 S.Horizon Blvd-8/10-9/9/2020	05520	Service Contracts	800.00	Planning and Zoning	GENERAL FUND
9/9/2020	Lower Valley Water District	Water Svc-Landscape 179 Horizon Blvd 8/10-9/9/2020	05313	Utilities	29.25	Public Works	GENERAL FUND
9/9/2020	Lower Valley Water District	Water Svc-11500 Flor Margarita-Jardin Flores Pk 8/10-9/9/20	05313	Utilities	6,126.25	Public Works	GENERAL FUND
9/9/2020	Lower Valley Water District	Water Svc-350 Flor Morada-Mauro Rosas Park 8/10-9/9/20	05313	Utilities	69.52	Public Works	GENERAL FUND
9/9/2020	Lower Valley Water District	WATER SVC-BULLDOG PK 61221901-8/10-9/9/2020	05313	Utilities	69.52	Public Works	GENERAL FUND
9/9/2020	Lower Valley Water District	WATER SVC-BULLDOG PK 61222001-8/10-9/9/2020	05313	Utilities	1,141.01	Public Works	GENERAL FUND
9/9/2020	Lower Valley Water District	WATER SVC-BULLDOG PK 61222001-8/10-9/9/2020	05311	Building & Property Maintenanc	105.00	Public Works	GENERAL FUND
9/9/2020	Lower Valley Water District	Water/Disposal svcs-10664 Socorro Rd. 8/10-9/9/2020	05313	Utilities	187.63	Public Works	GENERAL FUND
9/9/2020	Lower Valley Water District	Water svc-700 Delhi Dr- 8/10-9/9/2020	05313	Utilities	35.64	Public Works	GENERAL FUND
9/9/2020	Lower Valley Water District	Water Svcs-240 Moon Rd-8/10-9/9/2020	05313	Utilities	155.52	Police Department	GENERAL FUND
9/9/2020	Lower Valley Water District	Water svc-11471 Park Ln - 8/10-9/9/2020	05313	Utilities	440.30	Public Works	GENERAL FUND
9/2/2020	Lower Valley Water District	WATER/DISPOSAL SVC@317 VINEYARD-ACCT#60252101003 8/4-9/2/20	05313	Utilities	55.07	Police Department	GENERAL FUND
9/2/2020	Lower Valley Water District	WATER/DISPOSAL SVC@317 VINEYARD-ACCT#60252101003 8/4-9/2/20	05311	Building & Property Maintenanc	79.40	Police Department	GENERAL FUND
9/17/2020	Lujan Trucking	PO99918-TOPSOIL-240 N MOON	07502	Building and Facilities	240.00	Capital Projects Fund	CAPITAL PROJECTS 2019 CO's
9/1/2020	Metropolitan Life Insurance Co	CITY OF SOCORRO LIFE INS- CUST#5924	05116	Life Insurance	61.90	City Clerk	GENERAL FUND
9/1/2020	Metropolitan Life Insurance Co	CITY OF SOCORRO LIFE INS- CUST#5924	05116	Life Insurance	172.55	City Manager	GENERAL FUND
9/1/2020	Metropolitan Life Insurance Co	CITY OF SOCORRO LIFE INS- CUST#5924	05116	Life Insurance	25.10	Finance Department	GENERAL FUND
9/1/2020	Metropolitan Life Insurance Co	CITY OF SOCORRO LIFE INS- CUST#5924	05116	Life Insurance	21.82	Mayor and City Council	GENERAL FUND
9/1/2020	Metropolitan Life Insurance Co	CITY OF SOCORRO LIFE INS- CUST#5924	05116	Life Insurance	101.03	Municipal Court	GENERAL FUND

Date	Name	Transaction Description	Code	GL Description	Amount	Department	Fund
9/1/2020	Metropolitan Life Insurance Co	CITY OF SOCORRO LIFE INS- CUST#5924	05116	Life Insurance	539.95	Police Department	GENERAL FUND
9/1/2020	Metropolitan Life Insurance Co	CITY OF SOCORRO LIFE INS- CUST#5924	05116	Life Insurance	153.16	Planning and Zoning	GENERAL FUND
9/1/2020	Metropolitan Life Insurance Co	CITY OF SOCORRO LIFE INS- CUST#5924	05116	Life Insurance	259.98	Public Works	GENERAL FUND
9/1/2020	Metropolitan Life Insurance Co	CITY OF SOCORRO LIFE INS- CUST#5924	05116	Life Insurance	59.56	Recreation Centers	GENERAL FUND
9/1/2020	Metropolitan Life Insurance Co	CITY OF SOCORRO LIFE INS- CUST#5924	05116	Life Insurance	9.08	Grants and Special Projects	GENERAL FUND
9/1/2020	Metropolitan Life Insurance Co	CITY OF SOCORRO LIFE INS- CUST#5924	05116	Life Insurance	9.25	Information Technology	GENERAL FUND
9/11/2020	Miguel Martinez	PO99916-AC MAINTENANCE FOR RVCC UNIT	05311	Building & Property Maintenanc	368.00	Recreation Centers	GENERAL FUND
9/23/2020	Miguel Martinez	PO99916-AC REPAIR FOR CACC ARCADE ROOM	05311	Building & Property Maintenanc	1,236.07	Recreation Centers	GENERAL FUND
9/30/2020	Monique Velarde	PO25272-SVC CONTRACT-MUNICIPAL JUDGE-SEP 2020	05520	Service Contracts	3,541.66	Municipal Court	GENERAL FUND
9/30/2020	Mounce, Green, Myers, Safi &	PO25293-LEGAL FEES-SEP 2020	05411	Legal Fees	566.06	City Clerk	GENERAL FUND
9/30/2020	Mounce, Green, Myers, Safi &	PO25293-LEGAL FEES-SEP 2020	05411	Legal Fees	970.40	City Manager	GENERAL FUND
9/30/2020	Mounce, Green, Myers, Safi &	PO25293-LEGAL FEES-SEP 2020	05411	Legal Fees	1,455.59	Finance Department	GENERAL FUND
9/30/2020	Mounce, Green, Myers, Safi &	PO25293-LEGAL FEES-SEP 2020	05411	Legal Fees	154.38	Human Resources	GENERAL FUND
9/30/2020	Mounce, Green, Myers, Safi &	PO25293-LEGAL FEES-SEP 2020	05411	Legal Fees	1,646.73	Municipal Court	GENERAL FUND
9/30/2020	Mounce, Green, Myers, Safi &	PO25293-LEGAL FEES-SEP 2020	05411	Legal Fees	6,811.18	City Manager	GENERAL FUND
9/30/2020	Mounce, Green, Myers, Safi &	PO25293-LEGAL FEES-SEP 2020	05411	Legal Fees	396.98	Police Department	GENERAL FUND
9/30/2020	Mounce, Green, Myers, Safi &	PO25293-LEGAL FEES-SEP 2020	05411	Legal Fees	3,647.32	Public Works	GENERAL FUND
9/30/2020	Mounce, Green, Myers, Safi &	PO25293-LEGAL FEES-SEP 2020	05411	Legal Fees	4,164.37	Planning and Zoning	GENERAL FUND
9/1/2020	MuniCode	PO99914-ONLINE CODE HOSTING 9/1/2020-8/31/2021	05520	Service Contracts	950.00	City Clerk	GENERAL FUND
9/25/2020	Munoz, Jasiel	PO99905-REIMB-SAFETY & EMISSION INSPECTION UNIT 1400	05612	Vehicle Repair & Maintenance	18.50	Police Department	GENERAL FUND
9/25/2020	Munoz, Jasiel	PO99905-REIMB-VEHICLE REGISTRATION RENEWAL-UNIT 1400	05612	Vehicle Repair & Maintenance	8.25	Police Department	GENERAL FUND
9/15/2020	N7 Tactical Training, LLC	PO99905-BASIC SWAT TRNG-OFC J.DOMINGUEZ 9/28-10/2/20 CARLSBA	05527	Seminars/Training/Workshops	750.00	Police Department	GENERAL FUND

Date	Name	Transaction Description	Code	GL Description	Amount	Department	Fund
9/24/2020	Nationwide Retirement Solution	NATIONWIDE RETIREMENT PAYROLL DEDUCTIONS PPE 9/19/20	02602	Deferred Compensation Withheld	5,544.90		GENERAL FUND
9/24/2020	Nationwide Retirement Solution	NATIONWIDE RETIREMENT PAYROLL DEDUCTIONS PPE 9/19/20	02620	Deferred Compensation Payable	4,781.93		GENERAL FUND
9/10/2020	Nationwide Retirement Solution	NATIONWIDE RETIREMENT PAYROLL DEDUCTIONS PPE 9/5/2020	02602	Deferred Compensation Withheld	5,544.90		GENERAL FUND
9/10/2020	Nationwide Retirement Solution	NATIONWIDE RETIREMENT PAYROLL DEDUCTIONS PPE 9/5/2020	02620	Deferred Compensation Payable	4,781.93		GENERAL FUND
9/10/2020	Office Depot	PO99907-LETTER TRAY	05201	Office Expense and Supplies	79.94	Planning and Zoning	GENERAL FUND
9/9/2020	Office Depot	PO99907-CLIPS,DESK ORGANIZR,BSN CARD HOLDR,SORTER,FILE HOLDR	05201	Office Expense and Supplies	410.29	Planning and Zoning	GENERAL FUND
9/9/2020	Office Depot	PO99907-STORAGE CABINET	05201	Office Expense and Supplies	259.98	Planning and Zoning	GENERAL FUND
9/21/2020	Office Depot	PO99905-BSN CARD HOLDER,PENCL CUP,SORTER,PINS,RBBANDS,WIPES,	05201	Office Expense and Supplies	87.63	Police Department	SPECIAL REVENUES FUND
9/25/2020	Office Depot	PO99907-FILE FOLDERS	05201	Office Expense and Supplies	11.98	Planning and Zoning	GENERAL FUND
9/25/2020	Office Depot	PO99907-DESK ORGANIZER	05201	Office Expense and Supplies	59.77	Planning and Zoning	GENERAL FUND
9/26/2020	Office Depot	PO99907-ARTIFICIAL PALM TREE	05201	Office Expense and Supplies	122.99	Planning and Zoning	GENERAL FUND
9/24/2020	Office Depot	PO99907-STORAGE BOXES,POST ITS,DUSTER,PAPER,FOLDERS,KNIFE,PE	05201	Office Expense and Supplies	826.24	Planning and Zoning	GENERAL FUND
9/24/2020	Office Depot	PO99907-GAME CHAIR	05201	Office Expense and Supplies	209.99	Planning and Zoning	GENERAL FUND
9/24/2020	Office Depot	PO99907-PHONE MESSAGE BOOK	05201	Office Expense and Supplies	17.00	Planning and Zoning	GENERAL FUND
9/30/2020	Omnibase Services of Texas, LP	PO99906-1ST QTR ACTIVITY-JUL THRU SEP 2020	02613	OMNI Collections	2,132.33	Municipal Court	GENERAL FUND
9/30/2020	Omnibase Services of Texas, LP	PO99906-1ST QTR ACTIVITY-JUL THRU SEP 2020	04507	Muni. Court Judgements/Fines		Municipal Court	GENERAL FUND
9/3/2020	Petty Cash	PO99913-AIR FILTERS FOR CITY COUNCIL CHAMBERS	05201	Office Expense and Supplies	6.90	Mayor and City Council	GENERAL FUND
9/25/2020	Pitney Bowes	PO99907-POSTAGE METER INK CARTRIDGES-PZ	05201	Office Expense and Supplies	145.65	Planning and Zoning	GENERAL FUND
9/29/2020	Praxair Distribution, Inc.	PO99903-CYLINDER RENTALS	05212	Tools and Supplies	78.28	Public Works	GENERAL FUND
9/22/2020	Praxair Distribution, Inc.	PO99903-CYLINDER RENTALS	05212	Tools and Supplies	46.11	Public Works	GENERAL FUND
9/21/2020	Premier Uniforms & Tactical	PO99905-STINGER/RING/BATAN HOLDERS,KEEPERS,TAGS-NEW OFFICERS	05212	Tools and Supplies	587.20	Police Department	GENERAL FUND
9/20/2020	Purchase Power	Postage	05211	Postage	806.50	Planning and Zoning	GENERAL FUND
9/6/2020	Purchase Power	PO99906-POSTAGE METER REFILL	05211	Postage	1,008.50	Municipal Court	GENERAL FUND
9/5/2020	Rodarte's Tire & Wheels	PO99905-TIRE REPAIR UNIT 1601	05612	Vehicle Repair & Maintenance	30.00	Police Department	GENERAL FUND
9/4/2020	Rodarte's Tire & Wheels	PO99905-TIRE REPAIR UNIT 2003	05612	Vehicle Repair & Maintenance	15.00	Police Department	GENERAL FUND
9/29/2020	Rodarte's Tire & Wheels	PO99905-TIRE ROTATION-UNIT 1801	05612	Vehicle Repair & Maintenance	30.00	Police Department	GENERAL FUND
9/1/2020	Safe Life Defense	PO99905-BODY ARMOR FOR OFFICERS	05810	Property and Equipment	4,803.75	Police Department	GENERAL FUND

Date	Name	Transaction Description	Code	GL Description	Amount	Department	Fund
9/30/2020	SBNG, PC	PO99915-PROGRESS BILLING AUDIT SVCS FY 2020	05512	Audit Fees	584.75	Finance Department	GENERAL FUND
9/24/2020	Socorro Police Officers Assoc.	SPOA-EMPLOYEE LIST ATTACHED PPE 09/19/2020	02597	Socorro Police Officers Assoc.	20.00	Police Department	GENERAL FUND
9/10/2020	Socorro Police Officers Assoc.	SPOA-EMPLOYEE LIST ATTACHED PPE 09/05/2020	02597	Socorro Police Officers Assoc.	20.00	Police Department	GENERAL FUND
9/3/2020	Socorro Shamrock Ser. & Towing	PO99905-TOWING SVC-'03 FORD F150	05520	Service Contracts	139.50	Police Department	GENERAL FUND
9/20/2020	Socorro Shamrock Ser. & Towing	PO99905-TOWING SVC-'72 CHEVY CHEVELLE	05520	Service Contracts	179.00	Police Department	GENERAL FUND
9/18/2020	Socorro Shamrock Ser. & Towing	PO99905-TOWING SVC-'18 NISSAN TITAN	05520	Service Contracts	169.50	Police Department	GENERAL FUND
9/30/2020	Socorro Shamrock Service	PO99905-SAFETY & EMISSION INSPECTION- UNIT '16 HYUNDAI SONATA	05612	Vehicle Repair & Maintenance	18.50	Police Department	GENERAL FUND
9/24/2020	Socorro Shamrock Service	PO99905-SAFETY & EMISSION INSPECTION UNIT 1601	05612	Vehicle Repair & Maintenance	18.50	Police Department	GENERAL FUND
9/1/2020	Socorro Shamrock Service	PO99905-SAFETY INSPECTION UNIT 2002	05612	Vehicle Repair & Maintenance	7.00	Police Department	GENERAL FUND
9/1/2020	Socorro Shamrock Service	PO99905-SAFETY INSPECTION UNIT 2001	05612	Vehicle Repair & Maintenance	7.00	Police Department	GENERAL FUND
9/1/2020	Socorro Shamrock Service	PO99905-SAFETY INSPECTION UNIT 2003	05612	Vehicle Repair & Maintenance	7.00	Police Department	GENERAL FUND
9/1/2020	Southern Tire Mart, LLC	PO99905-TIRES-UNIT 1104	05612	Vehicle Repair & Maintenance	632.50	Police Department	GENERAL FUND
9/1/2020	Southern Tire Mart, LLC	PO99905-TIRES-UNIT 1405	05612	Vehicle Repair & Maintenance	727.50	Police Department	GENERAL FUND
9/13/2020	Sparkletts & Sierra Springs	PO99906-WATER DELIVERY SVC-AUG/SEP 2020	05201	Office Expense and Supplies	37.25	Municipal Court	GENERAL FUND
9/13/2020	Sparkletts & Sierra Springs	Water Delivery Services	05201	Office Expense and Supplies	116.68	City Manager	GENERAL FUND
9/13/2020	Sparkletts & Sierra Springs	PO99916-WATER DELIVERY SVC CACC- AUG/SEP 2020	05520	Service Contracts	26.76	Recreation Centers	GENERAL FUND
9/13/2020	Sparkletts & Sierra Springs	PO99916-WATER DELIVERY SVC RVCC- AUG/SEP 2020	05520	Service Contracts	83.70	Recreation Centers	GENERAL FUND
9/13/2020	Sparkletts & Sierra Springs	PO99905-WATER DELIVERY SVC-AUG/SEP 2020	05201	Office Expense and Supplies	230.82	Police Department	GENERAL FUND
9/13/2020	Sparkletts & Sierra Springs	Office Supplies/Water	05201	Office Expense and Supplies	62.22	Planning and Zoning	GENERAL FUND
9/13/2020	Sparkletts & Sierra Springs	PO99903-WATER DELIVERY SVC-AUG/SEP 2020	05201	Office Expense and Supplies	208.58	Public Works	GENERAL FUND
9/30/2020	State Comptroller	State Criminal Cost and Fees	02115	State Fees Payable	67,100.97	Municipal Court	GENERAL FUND
9/24/2020	Stuart C. Cox	Cases 18-30683-HCM, 16-31238-HCM - PPE 9/19/2020	02596	Bankruptcy Withheld	212.50		GENERAL FUND

Date	Name	Transaction Description	Code	GL Description	Amount	Department	Fund
9/10/2020	Stuart C. Cox	Cases 18-30683-HCM, 16-31238-HCM - PPE 9/5/2020	02596	Bankruptcy Withheld	212.50		GENERAL FUND
9/17/2020	Sun City Installations	PO99905-LIGHT KIT INSTALLATION UNIT 1600	05612	Vehicle Repair & Maintenance	2,243.48	Police Department	GENERAL FUND
9/17/2020	Sun City Installations	PO99905-LIGHT KITS INSTALLATION- POLARIS RANGER CREW 1000	05612	Vehicle Repair & Maintenance	985.92	Police Department	GENERAL FUND
9/24/2020	Sun City Installations	PO99905-EMERGENCY LIGHTS INSTALLATION-CREYs UNIT	05613	Equipment Repair & Maintenance	2,632.48	Police Department	GENERAL FUND
9/1/2020	Sun City Records	PO99902-MANAGEMENT/SERVICES OF RECORDS STORAGE	05520	Service Contracts	61.25	City Manager	GENERAL FUND
9/1/2020	Superior Copy Machines	PO99905-BASE RATE 6873 240 MOON- G706M460050-SEP 2020	05523	Equipment Rental/Lease	110.00	Police Department	GENERAL FUND
9/1/2020	Superior Copy Machines	PO99905-BASE RATE 4390 PD POONA- V9825400472-SEP 2020	05523	Equipment Rental/Lease	169.00	Police Department	GENERAL FUND
9/1/2020	Superior Copy Machines	PO99905-BASE RATE 6874 240 MOON- 3379PA00892-SEP 2020	05523	Equipment Rental/Lease	85.00	Police Department	GENERAL FUND
9/10/2020	Superior Copy Machines	PO99916-COPY OVERAGE RVCC ID#6203- 6/11-9/10/2020	05523	Equipment Rental/Lease	250.20	Recreation Centers	GENERAL FUND
9/11/2020	Superior Copy Machines	PO99903-OVERAGE RATE 6595 C507P401312 6/1-8/31/2020	05523	Equipment Rental/Lease	85.32	Public Works	GENERAL FUND
9/30/2020	Superior Copy Machines	Copier	05523	Equipment Rental/Lease	727.66	Planning and Zoning	GENERAL FUND
9/30/2020	Superior Copy Machines	PO25055-OVERAGE RATE-SC6280, 6280-01 7/1-9/30/20-PZ	05523	Equipment Rental/Lease	174.44	Planning and Zoning	GENERAL FUND
9/30/2020	Superior Copy Machines	PO99905-OVERAGE RATE 6873 240 MOON- G706M460050-SEP 2020	05523	Equipment Rental/Lease	28.67	Police Department	GENERAL FUND
9/30/2020	Superior Copy Machines	PO99906-BASE/OVRAGE RATE SX4400/MCID#9021A L7076442477 SEP20	05523	Equipment Rental/Lease	139.00	Municipal Court	GENERAL FUND
9/16/2020	Superior Copy Machines	PO99905-BASE RATE 6421 240 MOON- G145RA00947-8/17-9/16/2020	05523	Equipment Rental/Lease	95.00	Police Department	GENERAL FUND
9/16/2020	Superior Copy Machines	PO99905-OVERAGE RATE 6421 240 MOON- G145RA00947-8/17-9/16/20	05523	Equipment Rental/Lease	52.68	Police Department	GENERAL FUND
9/17/2020	Superior Copy Machines	PO99905-BASE RATE 6421 240 MOON- G145RA00947-9/17-10/16/2020	05523	Equipment Rental/Lease	95.00	Police Department	GENERAL FUND
9/1/2020	Superior Vision of Texas	VISION COVERAGE 03401001-SEPT 2020	05118	Vision Insurance Expense	21.61	Recreation Centers	GENERAL FUND
9/1/2020	Superior Vision of Texas	VISION COVERAGE 03401001-SEPT 2020	05118	Vision Insurance Expense	46.37	Planning and Zoning	GENERAL FUND
9/1/2020	Superior Vision of Texas	VISION COVERAGE 03401001-SEPT 2020	05118	Vision Insurance Expense	109.38	Public Works	GENERAL FUND
9/1/2020	Superior Vision of Texas	VISION COVERAGE 03401001-SEPT 2020	05118	Vision Insurance Expense	278.17	Police Department	GENERAL FUND
9/1/2020	Superior Vision of Texas	VISION COVERAGE 03401001-SEPT 2020	05118	Vision Insurance Expense	29.72	Municipal Court	GENERAL FUND

Date	Name	Transaction Description	Code	GL Description	Amount	Department	Fund
9/1/2020	Superior Vision of Texas	VISION COVERAGE 03401001-SEPT 2020	05118	Vision Insurance Expense	36.92	Mayor and City Council	GENERAL FUND
9/1/2020	Superior Vision of Texas	VISION COVERAGE 03401001-SEPT 2020	05118	Vision Insurance Expense	8.55	Information Technology	GENERAL FUND
9/1/2020	Superior Vision of Texas	VISION COVERAGE 03401001-SEPT 2020	05118	Vision Insurance Expense	8.55	Grants and Special Projects	GENERAL FUND
9/1/2020	Superior Vision of Texas	VISION COVERAGE 03401001-SEPT 2020	05118	Vision Insurance Expense	21.16	Finance Department	GENERAL FUND
9/1/2020	Superior Vision of Texas	VISION COVERAGE 03401001-SEPT 2020	05118	Vision Insurance Expense	73.37	City Manager	GENERAL FUND
9/1/2020	Superior Vision of Texas	VISION COVERAGE 03401001-SEPT 2020	05118	Vision Insurance Expense	4.50	City Clerk	GENERAL FUND
9/30/2020	TCS Total Cleaning	PO99905-CLEANING SVCS-240 N MOON	05311	Building & Property Maintenanc	1,275.00	Police Department	GENERAL FUND
9/30/2020	TCS Total Cleaning	PO99905-DISINFECTING SVCS-240 N MOON COVID19	05311	Building & Property Maintenanc	495.00	Police Department	CARES ACT FUND
9/24/2020	Texas Gas Service	GAS SVC 104 HORIZON 8/21-9/24/2020	05313	Utilities	162.98	City Manager	GENERAL FUND
9/24/2020	Texas Gas Service	GAS SVC - 901 RIO VISTA RD- RVCC 8/21-9/24/2020	05313	Utilities	163.37	Recreation Centers	GENERAL FUND
9/24/2020	Texas Gas Service	GAS SVCS @ 241 N. MOON RD 8/21-9/24/2020	05313	Utilities	158.69	Public Works	GENERAL FUND
9/24/2020	Texas Gas Service	GAS SVC 800 RVPD SUB FARM 8/21-9/24/2020	05313	Utilities	166.89	Police Department	GENERAL FUND
9/24/2020	Texas Gas Service	GAS SVC 241 OLD HUECO TANKS 8/21-9/24/2020	05313	Utilities	158.69	Public Works	GENERAL FUND
9/24/2020	Texas Gas Service	GAS SVC 10200 CALCUTTA DR 8/21-9/24/2020	05313	Utilities	158.69	Police Department	GENERAL FUND
9/22/2020	Texas Gas Service	GAS SVC 317 VINEYARD 8/18-9/22/2020	05313	Utilities	60.69	Police Department	GENERAL FUND
9/30/2020	Tigua Facility Services, Inc.	Sept 2020	05525	Health/Ambulance Contract	5,833.33	Health Department	GENERAL FUND
9/1/2020	Time Warner Cable	Cable svc-670 POONA PD-08/30-9/29/2020	05313	Utilities	104.60	Police Department	GENERAL FUND
9/5/2020	Time Warner Cable	INTERNET/PHONE/TV SVC-317 VINEYARD PD-SEP 2020	05313	Utilities	109.71	Police Department	GENERAL FUND
9/7/2020	Time Warner Cable	Internet svc-670 POONA PD-9/7-10/6/2020	05313	Utilities	221.10	Police Department	GENERAL FUND
9/30/2020	TruePoint Solutions, LLC	Accela Implementation	05520	Service Contracts	330.00	Planning and Zoning	GENERAL FUND
9/1/2020	Tuff Shed Storage Buildings	Modular Bldg Site	07502	Building and Facilities	4,919.00	Capital Projects Fund	CAPITAL PROJECTS 2019 CO's
9/1/2020	Unifirst Corporation	PO99905-CLEANING PRODUCTS & SVCS-PD	05520	Service Contracts	30.92	Police Department	GENERAL FUND
9/1/2020	Unifirst Corporation	PO99905-CLEANING PRODUCTS & SVCS-PD	05520	Service Contracts	38.64	Police Department	GENERAL FUND
9/8/2020	Unifirst Corporation	PO99905-CLEANING PRODUCTS & SVCS-PD	05520	Service Contracts	38.64	Police Department	GENERAL FUND

Date	Name	Transaction Description	Code	GL Description	Amount	Department	Fund
9/8/2020	Unifirst Corporation	PO99905-CLEANING PRODUCTS & SVCS-PD	05520	Service Contracts	53.42	Police Department	GENERAL FUND
9/29/2020	Unifirst Corporation	PO99905-CLEANING PRODUCTS & SVCS-PD	05520	Service Contracts	38.64	Police Department	GENERAL FUND
9/29/2020	Unifirst Corporation	PO99905-CLEANING PRODUCTS & SVCS-PD	05520	Service Contracts	30.92	Police Department	GENERAL FUND
9/22/2020	Unifirst Corporation	PO99905-CLEANING PRODUCTS & SVCS-PD	05520	Service Contracts	38.64	Police Department	GENERAL FUND
9/22/2020	Unifirst Corporation	PO99905-CLEANING PRODUCTS & SVCS-PD	05520	Service Contracts	164.33	Police Department	GENERAL FUND
9/15/2020	Unifirst Corporation	PO99905-CLEANING PRODUCTS & SVCS-PD	05520	Service Contracts	38.64	Police Department	GENERAL FUND
9/15/2020	Unifirst Corporation	PO99905-CLEANING PRODUCTS & SVCS-PD	05520	Service Contracts	30.92	Police Department	GENERAL FUND
9/30/2020	Verizon Wireless	Acct# 965739630-00001 WIRELESS PHONE SVC-9/2-10/1/2020	05314	Telephone	248.46	City Manager	GENERAL FUND
9/30/2020	Verizon Wireless	Acct# 965739630-00001 WIRELESS PHONE SVC-9/2-10/1/2020	05314	Telephone	324.65	Public Works	GENERAL FUND
9/30/2020	Verizon Wireless	Acct# 965739630-00001 WIRELESS PHONE SVC-9/2-10/1/2020	05314	Telephone	1,080.10	Police Department	GENERAL FUND
9/30/2020	Verizon Wireless	Acct# 965739630-00001 WIRELESS PHONE SVC-9/2-10/1/2020	05314	Telephone	469.19	Planning and Zoning	GENERAL FUND
9/30/2020	Verizon Wireless	Acct# 965739630-00001 WIRELESS PHONE SVC-9/2-10/1/2020	05314	Telephone	314.42	Mayor and City Council	GENERAL FUND
9/30/2020	Verizon Wireless	Acct# 965739630-00001 WIRELESS PHONE SVC-9/2-10/1/2020	05314	Telephone	48.25	City Clerk	GENERAL FUND
9/30/2020	Verizon Wireless	Acct# 965739630-00001 WIRELESS PHONE SVC-9/2-10/1/2020	05314	Telephone	48.25	Finance Department	GENERAL FUND
9/30/2020	Verizon Wireless	Acct# 965739630-00001 WIRELESS PHONE SVC-9/2-10/1/2020	05314	Telephone	433.62	Recreation Centers	GENERAL FUND
9/30/2020	Verizon Wireless	Acct# 965739630-00001 WIRELESS PHONE SVC-9/2-10/1/2020	05314	Telephone	40.21	Grants and Special Projects	GENERAL FUND
9/30/2020	Verizon Wireless	Acct# 965739630-00001 WIRELESS PHONE SVC-9/2-10/1/2020	05314	Telephone	48.25	Municipal Court	GENERAL FUND
9/30/2020	Verizon Wireless	Acct# 965739630-00001 WIRELESS PHONE SVC-9/2-10/1/2020	05314	Telephone	190.17	Recreation Centers	SPECIAL REVENUES FUND
9/30/2020	Watson Pest Control	PO99902-SANITIZATION-PW DEPT COVID19	05311	Building & Property Maintenanc	300.00	City Manager	CARES ACT FUND
9/30/2020	Watson Pest Control	PO99902-SANITIZATION-PD DEPT COVID19	05311	Building & Property Maintenanc	400.00	City Manager	CARES ACT FUND
9/28/2020	Watson Pest Control	PO99902-SANITIZATION-PD DEPT COVID19	05311	Building & Property Maintenanc	400.00	City Manager	CARES ACT FUND
9/24/2020	Watson Pest Control	Pest Control Services	05311	Building & Property Maintenanc	75.00	City Manager	GENERAL FUND

Date	Name	Transaction Description	Code	GL Description	Amount	Department	Fund
9/24/2020	Watson Pest Control	PO99906-MONTHLY PEST CONTROL-SEP 2020	05311	Building & Property Maintenanc	75.00	Municipal Court	GENERAL FUND
9/24/2020	Watson Pest Control	PO99905-MONTHLY PEST CONTROL 240 N MOON-SEP 2020	05520	Service Contracts	50.00	Police Department	GENERAL FUND
9/24/2020	Watson Pest Control	PO99905-MONTHLY PEST CONTROL-SEP 2020	05520	Service Contracts	50.00	Police Department	GENERAL FUND
9/24/2020	Watson Pest Control	PO99905-MONTHLY PEST CONTROL-SEP 2020	05520	Service Contracts	50.00	Police Department	GENERAL FUND
9/25/2020	Watson Pest Control	PO99902-SANITIZATION-CACC COVID19	05311	Building & Property Maintenanc	250.00	City Manager	CARES ACT FUND
9/25/2020	Watson Pest Control	PO99902-SANITIZATION-PD DEPT COVID19	05311	Building & Property Maintenanc	400.00	City Manager	CARES ACT FUND
9/25/2020	Watson Pest Control	PO99902-SANITIZATION-CM DEPT COVID19	05311	Building & Property Maintenanc	350.00	City Manager	CARES ACT FUND
9/25/2020	Watson Pest Control	PO99902-SANITIZATION-RVCC COVID19	05311	Building & Property Maintenanc	300.00	City Manager	CARES ACT FUND
9/25/2020	Watson Pest Control	PO99902-SANITIZATION-PW DEPT COVID19	05311	Building & Property Maintenanc	300.00	City Manager	CARES ACT FUND
9/16/2020	Watson Pest Control	PO99902-SANITIZATION-PW DEPT COVID19	05311	Building & Property Maintenanc	300.00	City Manager	CARES ACT FUND
9/16/2020	Watson Pest Control	PO99902-SANITIZATION-PD DEPT COVID19	05311	Building & Property Maintenanc	400.00	City Manager	CARES ACT FUND
9/18/2020	Watson Pest Control	PO99902-SANITIZATION-CACC COVID19	05311	Building & Property Maintenanc	250.00	City Manager	CARES ACT FUND
9/21/2020	Watson Pest Control	PO99902-SANITIZATION-PD DEPT COVID19	05311	Building & Property Maintenanc	400.00	City Manager	CARES ACT FUND
9/23/2020	Watson Pest Control	PO99902-SANITIZATION-PD DEPT COVID19	05311	Building & Property Maintenanc	400.00	City Manager	CARES ACT FUND
9/23/2020	Watson Pest Control	PO99902-SANITIZATION-PW DEPT COVID19	05311	Building & Property Maintenanc	300.00	City Manager	CARES ACT FUND
9/18/2020	Watson Pest Control	PO99902-SANITIZATION-CM DEPT COVID19	05311	Building & Property Maintenanc	350.00	City Manager	CARES ACT FUND
9/18/2020	Watson Pest Control	PO99902-SANITIZATION-PD DEPT COVID19	05311	Building & Property Maintenanc	400.00	City Manager	CARES ACT FUND
9/18/2020	Watson Pest Control	PO99902-SANITIZATION-PW DEPT COVID19	05311	Building & Property Maintenanc	300.00	City Manager	CARES ACT FUND
9/18/2020	Watson Pest Control	PO99902-SANITIZATION-RVCC DEPT COVID19	05311	Building & Property Maintenanc	300.00	City Manager	CARES ACT FUND
9/9/2020	Watson Pest Control	PO99902-SANITIZATION-PD DEPT COVID19	05311	Building & Property Maintenanc	400.00	City Manager	CARES ACT FUND
9/9/2020	Watson Pest Control	PO99902-SANITIZATION-PW DEPT COVID19	05311	Building & Property Maintenanc	300.00	City Manager	CARES ACT FUND
9/14/2020	Watson Pest Control	PO99902-SANITIZATION-PD DEPT COVID19	05311	Building & Property Maintenanc	400.00	City Manager	CARES ACT FUND

Date	Name	Transaction Description	Code	GL Description	Amount	Department	Fund
9/11/2020	Watson Pest Control	PO99902-SANITIZATION-PD DEPT COVID19	05311	Building & Property Maintenanc	400.00	City Manager	CARES ACT FUND
9/11/2020	Watson Pest Control	PO99902-SANITIZATION-CM DEPT COVID19	05311	Building & Property Maintenanc	350.00	City Manager	CARES ACT FUND
9/11/2020	Watson Pest Control	PO99902-SANITIZATION-CACC DEPT COVID19	05311	Building & Property Maintenanc	250.00	City Manager	CARES ACT FUND
9/11/2020	Watson Pest Control	PO99902-SANITIZATION-PW DEPT COVID19	05311	Building & Property Maintenanc	300.00	City Manager	CARES ACT FUND
9/11/2020	Watson Pest Control	PO99902-SANITIZATION-RVCC DEPT COVID19	05311	Building & Property Maintenanc	300.00	City Manager	CARES ACT FUND
9/2/2020	Watson Pest Control	PO99902-SANITIZATION-PD DEPT COVID19	05311	Building & Property Maintenanc	400.00	City Manager	CARES ACT FUND
9/2/2020	Watson Pest Control	PO99902-SANITIZATION-PW DEPT COVID19	05311	Building & Property Maintenanc	300.00	City Manager	CARES ACT FUND
9/4/2020	Watson Pest Control	PO99902-SANITIZATION-RVCC DEPT COVID19	05311	Building & Property Maintenanc	300.00	City Manager	CARES ACT FUND
9/4/2020	Watson Pest Control	PO99902-SANITIZATION-CACC DEPT COVID19	05311	Building & Property Maintenanc	250.00	City Manager	CARES ACT FUND
9/4/2020	Watson Pest Control	PO99902-SANITIZATION-CM DEPT COVID19	05311	Building & Property Maintenanc	350.00	City Manager	CARES ACT FUND
9/4/2020	Watson Pest Control	PO99902-SANITIZATION-PW DEPT COVID19	05311	Building & Property Maintenanc	300.00	City Manager	CARES ACT FUND
9/4/2020	Wells Fargo Visa Card	PO99905-ONLINE TRNG FOR SEVERAL OFFICERS	05527	Seminars/Training/Workshops	270.00	Police Department	GENERAL FUND
9/4/2020	Wells Fargo Visa Card	PO99905-ONLINE TRNG FOR SEVERAL OFFICERS	05527	Seminars/Training/Workshops	120.00	Police Department	GENERAL FUND
9/4/2020	Wells Fargo Visa Card	PO99905-ONLINE TRNG FOR SEVERAL OFFICERS	05527	Seminars/Training/Workshops	85.00	Police Department	GENERAL FUND
9/4/2020	Wells Fargo Visa Card	PO99905-ONLINE TRNG FOR SEVERAL OFFICERS	05527	Seminars/Training/Workshops	60.00	Police Department	GENERAL FUND
9/4/2020	Wells Fargo Visa Card	PO99905-MASTER PEACE OFFICER CERT-OFC VALERA	05527	Seminars/Training/Workshops	66.00	Police Department	GENERAL FUND
9/4/2020	Wells Fargo Visa Card	PO99905-MASTER PEACE OFFICER CERT-OFC VALERA	01100	Accounts Receivable	4.64	Police Department	GENERAL FUND
9/5/2020	Wells Fargo Visa Card	PO99916-SECURITY SYSTEM SVCS-CACC	05520	Service Contracts	118.71	Recreation Centers	GENERAL FUND
9/4/2020	Wells Fargo Visa Card	PO99905-ACCENT CHAIRS-CRIME VICTIMS OFFICE	05201	Office Expense and Supplies	259.98	Police Department	SPECIAL REVENUES FUND
9/4/2020	Wells Fargo Visa Card	PO99905-ACCENT CHAIRS-CRIME VICTIMS OFFICE	01251	Inter-Fund Receivable			SPECIAL REVENUES FUND
9/4/2020	Wells Fargo Visa Card	PO99905-ACCENT CHAIRS-CRIME VICTIMS OFFICE	01251	Inter-Fund Receivable	259.98		GENERAL FUND
9/4/2020	Wells Fargo Visa Card	PO99905-BLANKETS,SLEEPING BAG,CAR SEATS-CRIME VICTIMS	05201	Office Expense and Supplies	472.51	Police Department	SPECIAL REVENUES FUND

Date	Name	Transaction Description	Code	GL Description	Amount	Department	Fund
9/4/2020	Wells Fargo Visa Card	PO99905-BLANKETS,SLEEPING BAG,CAR SEATS-CRIME VICTIMS	01251	Inter-Fund Receivable			SPECIAL REVENUES FUND
9/4/2020	Wells Fargo Visa Card	PO99905-BLANKETS,SLEEPING BAG,CAR SEATS-CRIME VICTIMS	01251	Inter-Fund Receivable	472.51		GENERAL FUND
9/2/2020	Wells Fargo Visa Card	PO99907-CEO RENEWAL-CODE ENFORCER G. SALAZAR	05516	Dues/Subscriptions	75.00	Planning and Zoning	GENERAL FUND
9/3/2020	Wells Fargo Visa Card	PO99905-CREDIT-BATTERY CORE-UNIT 1802	05612	Vehicle Repair & Maintenance		Police Department	GENERAL FUND
9/4/2020	Wells Fargo Visa Card	PO99903-COCOA MATS-PW21 PNEUMATIC	05613	Equipment Repair & Maintenance	205.20	Public Works	GENERAL FUND
9/4/2020	Wells Fargo Visa Card	PO99903-TIRE REPAIR-PW Z MOWER	05613	Equipment Repair & Maintenance	10.00	Public Works	GENERAL FUND
9/4/2020	Wells Fargo Visa Card	PO99903-AUTOCUT HEAD BULKS-PW TRIMMERS	05613	Equipment Repair & Maintenance	137.94	Public Works	GENERAL FUND
9/3/2020	Wells Fargo Visa Card	PO99902-SCREWGATE CARABIN,RATCHETING SET-CM MECHANIC SHOP	05212	Tools and Supplies	39.73	City Manager	GENERAL FUND
9/3/2020	Wells Fargo Visa Card	PO99905-DUSTY HOLSTERS FOR NEW OFFICERS	05212	Tools and Supplies	319.96	Police Department	GENERAL FUND
9/3/2020	Wells Fargo Visa Card	PO99905-SHIRTS FOR NEW OFFICERS	05213	Uniforms	282.85	Police Department	GENERAL FUND
9/3/2020	Wells Fargo Visa Card	PO99916-FILTERS-RVCC	05311	Building & Property Maintenanc	8.58	Recreation Centers	GENERAL FUND
9/3/2020	Wells Fargo Visa Card	PO99903-MOTOR OIL-PW Z MOWERS	05613	Equipment Repair & Maintenance	11.96	Public Works	GENERAL FUND
9/3/2020	Wells Fargo Visa Card	PO99903-WIPERS,HEADLIGHT BULBS,AIR FRESHENER-PW05	05612	Vehicle Repair & Maintenance	73.39	Public Works	GENERAL FUND
9/3/2020	Wells Fargo Visa Card	PO99903-SEAT CUSHION-PW25 ROLLER	05613	Equipment Repair & Maintenance	13.87	Public Works	GENERAL FUND
9/3/2020	Wells Fargo Visa Card	PO99903-CREDIT-BATHROOM FLUSH LEVER	05311	Building & Property Maintenanc		Public Works	GENERAL FUND
9/2/2020	Wells Fargo Visa Card	PO99903-BATHROOM FLUSH LEVERS	05311	Building & Property Maintenanc	21.98	Public Works	GENERAL FUND
9/1/2020	Wells Fargo Visa Card	PO99902-XTREME CLEANING-860 RIO VISTA-COVID19	05311	Building & Property Maintenanc	662.33	City Manager	CARES ACT FUND
9/1/2020	Wells Fargo Visa Card	PO99902-XTREME CLEANING-860 RIO VISTA-COVID19	01251	Inter-Fund Receivable			CARES ACT FUND
9/1/2020	Wells Fargo Visa Card	PO99902-XTREME CLEANING-860 RIO VISTA-COVID19	01251	Inter-Fund Receivable	662.33		GENERAL FUND
9/1/2020	Wells Fargo Visa Card	PO99902-INT'L FEE-ORGANIZATIONAL CHART PRO	05516	Dues/Subscriptions	2.16	City Manager	GENERAL FUND
9/2/2020	Wells Fargo Visa Card	PO99906-TONER AND INK CARTRIDGES	05201	Office Expense and Supplies	1,362.14	Municipal Court	GENERAL FUND

Date	Name	Transaction Description	Code	GL Description	Amount	Department	Fund
9/1/2020	Wells Fargo Visa Card	PO99903-MATERIAL-RIO VISTA SIDEWALK	05312	Street Maintenance	1,702.63	Public Works	GENERAL FUND
9/1/2020	Wells Fargo Visa Card	PO99905-ANGEL WINGS WALL DECOR-CRIME VICTIMs OFFICE	05201	Office Expense and Supplies	26.38	Police Department	SPECIAL REVENUES FUND
9/1/2020	Wells Fargo Visa Card	PO99905-ANGEL WINGS WALL DECOR-CRIME VICTIMs OFFICE	01251	Inter-Fund Receivable			SPECIAL REVENUES FUND
9/1/2020	Wells Fargo Visa Card	PO99905-ANGEL WINGS WALL DECOR-CRIME VICTIMs OFFICE	01251	Inter-Fund Receivable	26.38		GENERAL FUND
9/1/2020	Wells Fargo Visa Card	PO99903-DOOR KNOB-PPW SUPERVISOR'S OFFICE	05311	Building & Property Maintenanc	23.80	Public Works	GENERAL FUND
9/1/2020	Wells Fargo Visa Card	PO99925-GOOGLE DOMAINS RENEWAL	05520	Service Contracts	12.00	Information Technology	GENERAL FUND
9/1/2020	Wells Fargo Visa Card	PO99918-CREDIT-ADA PARKING STOPS	07502	Building and Facilities		Capital Projects Fund	CAPITAL PROJECTS 2019 CO's
9/1/2020	Wells Fargo Visa Card	PO99918-CREDIT-ADA PARKING STOPS	01251	Inter-Fund Receivable	365.24		CAPITAL PROJECTS 2019 CO's
9/1/2020	Wells Fargo Visa Card	PO99918-CREDIT-ADA PARKING STOPS	01251	Inter-Fund Receivable			GENERAL FUND
9/1/2020	Wells Fargo Visa Card	PO99916-3 PRONG PLUG ENDS	05201	Office Expense and Supplies	11.37	Recreation Centers	GENERAL FUND
9/1/2020	Wells Fargo Visa Card	PO99916-WIX eCOMMERCE SETUP	05520	Service Contracts	300.00	Recreation Centers	SPECIAL REVENUES FUND
9/1/2020	Wells Fargo Visa Card	PO99916-WIX eCOMMERCE SETUP	01251	Inter-Fund Receivable			SPECIAL REVENUES FUND
9/1/2020	Wells Fargo Visa Card	PO99916-WIX eCOMMERCE SETUP	01251	Inter-Fund Receivable	300.00		GENERAL FUND
9/1/2020	Wells Fargo Visa Card	PO99916-CREAMER	05201	Office Expense and Supplies	42.01	Recreation Centers	GENERAL FUND
9/1/2020	Wells Fargo Visa Card	PO99907/99912-800 NUMBER-VIRTUAL MEETINGS-COVID19	05314	Telephone	17.08	Planning and Zoning	CARES ACT FUND
9/1/2020	Wells Fargo Visa Card	PO99907/99912-800 NUMBER-VIRTUAL MEETINGS-COVID19	05314	Telephone	3.88	Human Resources	CARES ACT FUND
9/1/2020	Wells Fargo Visa Card	PO99907/99912-800 NUMBER-VIRTUAL MEETINGS-COVID19	01251	Inter-Fund Receivable			CARES ACT FUND
9/1/2020	Wells Fargo Visa Card	PO99907/99912-800 NUMBER-VIRTUAL MEETINGS-COVID19	01251	Inter-Fund Receivable	20.96		GENERAL FUND
9/1/2020	Wells Fargo Visa Card	PO99905-TUITION & TECNICAL ASST PYMT LAW TRNG-C.ALMANZA	05527	Seminars/Training/Workshops	175.00	Police Department	GENERAL FUND
9/1/2020	Wells Fargo Visa Card	PO99916-FAUCET-CACC	05311	Building & Property Maintenanc	71.76	Recreation Centers	GENERAL FUND
9/1/2020	Wells Fargo Visa Card	PO99905-EMISSION VEHICLE INSPECTION-UNIT 1602	05612	Vehicle Repair & Maintenance	19.24	Police Department	GENERAL FUND
9/1/2020	Wells Fargo Visa Card	PO99905-RESURFACE BRAKE ROTORS-UNIT 1401	05612	Vehicle Repair & Maintenance	40.00	Police Department	GENERAL FUND

Date	Name	Transaction Description	Code	GL Description	Amount	Department	Fund
9/1/2020	Wells Fargo Visa Card	PO99916-SUN CAPS WITH FACE MASKS	05201	Office Expense and Supplies	16.88	Recreation Centers	SPECIAL REVENUES FUND
9/1/2020	Wells Fargo Visa Card	PO99916-SUN CAPS WITH FACE MASKS	01251	Inter-Fund Receivable			SPECIAL REVENUES FUND
9/1/2020	Wells Fargo Visa Card	PO99916-SUN CAPS WITH FACE MASKS	01251	Inter-Fund Receivable	16.88		GENERAL FUND
9/11/2020	Wells Fargo Visa Card	PO99903-RING,FILTERS,BRAKET KIT,SHIELD,VBELT-PW Z MOWERS JDE	05613	Equipment Repair & Maintenance	654.88	Public Works	GENERAL FUND
9/11/2020	Wells Fargo Visa Card	PO99903-CREDIT-BRACKET KIT PW Z MOWERS JDEERE	05613	Equipment Repair & Maintenance		Public Works	GENERAL FUND
9/11/2020	Wells Fargo Visa Card	PO99903-FLAT HOOK RATCHETS	05212	Tools and Supplies	175.92	Public Works	GENERAL FUND
9/11/2020	Wells Fargo Visa Card	PO99905-OIL FILTERS,WIPERS-PD TAHOEs & EXPLORERs	05612	Vehicle Repair & Maintenance	190.05	Police Department	GENERAL FUND
9/11/2020	Wells Fargo Visa Card	PO99905-WIPERS-PD IMPALAs	05612	Vehicle Repair & Maintenance	140.72	Police Department	GENERAL FUND
9/11/2020	Wells Fargo Visa Card	PO99918-BLOCKS FOR LANDSCAPING-240 N MOON	07502	Building and Facilities	1,008.20	Capital Projects Fund	CAPITAL PROJECTS 2019 CO's
9/11/2020	Wells Fargo Visa Card	PO99918-BLOCKS FOR LANDSCAPING-240 N MOON	01251	Inter-Fund Receivable			CAPITAL PROJECTS 2019 CO's
9/11/2020	Wells Fargo Visa Card	PO99918-BLOCKS FOR LANDSCAPING-240 N MOON	01251	Inter-Fund Receivable	1,008.20		GENERAL FUND
9/12/2020	Wells Fargo Visa Card	PO99916-MONTHLY PEST CONTROL SVCS-RVCC	05520	Service Contracts	60.00	Recreation Centers	GENERAL FUND
9/14/2020	Wells Fargo Visa Card	Building & Property Supplies	05311	Building & Property Maintenanc	333.29	City Manager	GENERAL FUND
9/14/2020	Wells Fargo Visa Card	PO99903-BULBS,BATTERY,STARTING FLUID-PW26 PAVER	05613	Equipment Repair & Maintenance	137.95	Public Works	GENERAL FUND
9/14/2020	Wells Fargo Visa Card	PO99902-STORAGE BAGS-COVID19	05900	Emergency Aid and Assistance	21.87	City Manager	CARES ACT FUND
9/14/2020	Wells Fargo Visa Card	PO99902-STORAGE BAGS-COVID19	01251	Inter-Fund Receivable			CARES ACT FUND
9/14/2020	Wells Fargo Visa Card	PO99902-STORAGE BAGS-COVID19	01251	Inter-Fund Receivable	21.87		GENERAL FUND
9/14/2020	Wells Fargo Visa Card	PO99902-HAND SANITIZER,SANITIZING WIPES-COVID19	05900	Emergency Aid and Assistance	267.92	City Manager	CARES ACT FUND
9/14/2020	Wells Fargo Visa Card	PO99902-HAND SANITIZER,SANITIZING WIPES-COVID19	01251	Inter-Fund Receivable			CARES ACT FUND
9/14/2020	Wells Fargo Visa Card	PO99902-HAND SANITIZER,SANITIZING WIPES-COVID19	01251	Inter-Fund Receivable	267.92		GENERAL FUND
9/14/2020	Wells Fargo Visa Card	PO99902-HAND SANITIZER-COVID19	05900	Emergency Aid and Assistance	209.98	City Manager	CARES ACT FUND
9/14/2020	Wells Fargo Visa Card	PO99902-HAND SANITIZER-COVID19	01251	Inter-Fund Receivable			CARES ACT FUND

Date	Name	Transaction Description	Code	GL Description	Amount	Department	Fund
9/14/2020	Wells Fargo Visa Card	PO99902-HAND SANITIZER-COVID19	01251	Inter-Fund Receivable	209.98		GENERAL FUND
9/14/2020	Wells Fargo Visa Card	PO99902-DISINFECTING WIPES/CLEANER-COVID19	05900	Emergency Aid and Assistance	116.14	City Manager	CARES ACT FUND
9/14/2020	Wells Fargo Visa Card	PO99902-DISINFECTING WIPES/CLEANER-COVID19	01251	Inter-Fund Receivable			CARES ACT FUND
9/14/2020	Wells Fargo Visa Card	PO99902-DISINFECTING WIPES/CLEANER-COVID19	01251	Inter-Fund Receivable	116.14		GENERAL FUND
9/14/2020	Wells Fargo Visa Card	PO99902-SURFACE DISINFECTANT-COVID19	05900	Emergency Aid and Assistance	49.04	City Manager	CARES ACT FUND
9/14/2020	Wells Fargo Visa Card	PO99902-SURFACE DISINFECTANT-COVID19	01251	Inter-Fund Receivable			CARES ACT FUND
9/14/2020	Wells Fargo Visa Card	PO99902-SURFACE DISINFECTANT-COVID19	01251	Inter-Fund Receivable	49.04		GENERAL FUND
9/14/2020	Wells Fargo Visa Card	PO99902-SPRAY BOTTLES-COVID19	05900	Emergency Aid and Assistance	79.62	City Manager	CARES ACT FUND
9/14/2020	Wells Fargo Visa Card	PO99902-SPRAY BOTTLES-COVID19	01251	Inter-Fund Receivable			CARES ACT FUND
9/14/2020	Wells Fargo Visa Card	PO99902-SPRAY BOTTLES-COVID19	01251	Inter-Fund Receivable	79.62		GENERAL FUND
9/14/2020	Wells Fargo Visa Card	PO99905-VEHICLE REGISTRATION RENEWAL-UNIT 2002	05612	Vehicle Repair & Maintenance	9.45	Police Department	GENERAL FUND
9/14/2020	Wells Fargo Visa Card	PO99905-VEHICLE REGISTRATION RENEWAL-UNIT 2003	05612	Vehicle Repair & Maintenance	9.45	Police Department	GENERAL FUND
9/14/2020	Wells Fargo Visa Card	PO99913-COFFEE, CREAMERS, TP, TRSH BAGS, BROOM, PADS, CONTAINERS,	05201	Office Expense and Supplies	370.60	Mayor and City Council	GENERAL FUND
9/15/2020	Wells Fargo Visa Card	PO99906-FOLDERS, THUMB TACKS, CORRECTION TAPES, LABELS	05201	Office Expense and Supplies	292.92	Municipal Court	GENERAL FUND
9/15/2020	Wells Fargo Visa Card	Copier Paper	05201	Office Expense and Supplies	149.95	City Manager	GENERAL FUND
9/15/2020	Wells Fargo Visa Card	PO99916-GROCERIES-SUPPLIES FOR SOCIAL MEDIA CONTENT	05521	Support Activities	17.38	Recreation Centers	GENERAL FUND
9/15/2020	Wells Fargo Visa Card	PO99925-SSD DRIVE MOUNTING BRACKETS-COMPUTER TOWERS	05613	Equipment Repair & Maintenance	9.98	Information Technology	GENERAL FUND
9/15/2020	Wells Fargo Visa Card	PO99903-FRONT TIRE-PW33 BIG LOADER	05613	Equipment Repair & Maintenance	1,435.42	Public Works	GENERAL FUND
9/15/2020	Wells Fargo Visa Card	PO99903-2 CYCLE OIL, PAINT MARKER-PW TRIMMERS MIX	05613	Equipment Repair & Maintenance	106.55	Public Works	GENERAL FUND
9/15/2020	Wells Fargo Visa Card	PO99902-DISINFECTING WIPES-COVID19	05900	Emergency Aid and Assistance	19.92	City Manager	CARES ACT FUND
9/15/2020	Wells Fargo Visa Card	PO99902-DISINFECTING WIPES-COVID19	01251	Inter-Fund Receivable			CARES ACT FUND
9/15/2020	Wells Fargo Visa Card	PO99902-DISINFECTING WIPES-COVID19	01251	Inter-Fund Receivable	19.92		GENERAL FUND

Date	Name	Transaction Description	Code	GL Description	Amount	Department	Fund
9/15/2020	Wells Fargo Visa Card	PO99902-DISINFECTING WIPES-COVID19	05900	Emergency Aid and Assistance	6.64	City Manager	CARES ACT FUND
9/15/2020	Wells Fargo Visa Card	PO99902-DISINFECTING WIPES-COVID19	01251	Inter-Fund Receivable			CARES ACT FUND
9/15/2020	Wells Fargo Visa Card	PO99902-DISINFECTING WIPES-COVID19	01251	Inter-Fund Receivable	6.64		GENERAL FUND
9/15/2020	Wells Fargo Visa Card	PO99902-DISINFECTING WIPES-COVID19	05900	Emergency Aid and Assistance	359.50	City Manager	CARES ACT FUND
9/15/2020	Wells Fargo Visa Card	PO99902-DISINFECTING WIPES-COVID19	01251	Inter-Fund Receivable			CARES ACT FUND
9/15/2020	Wells Fargo Visa Card	PO99902-DISINFECTING WIPES-COVID19	01251	Inter-Fund Receivable	359.50		GENERAL FUND
9/15/2020	Wells Fargo Visa Card	PO99905-POWER STRIP,EXT CORDS,WIRELESS BLUETOOTH SPEAKER	05201	Office Expense and Supplies	219.18	Police Department	SPECIAL REVENUES FUND
9/15/2020	Wells Fargo Visa Card	PO99905-POWER STRIP,EXT CORDS,WIRELESS BLUETOOTH SPEAKER	01251	Inter-Fund Receivable			SPECIAL REVENUES FUND
9/15/2020	Wells Fargo Visa Card	PO99905-POWER STRIP,EXT CORDS,WIRELESS BLUETOOTH SPEAKER	01251	Inter-Fund Receivable	219.18		GENERAL FUND
9/15/2020	Wells Fargo Visa Card	PO99916-SPIRAL NOTEBOOKS	05201	Office Expense and Supplies	12.99	Recreation Centers	GENERAL FUND
9/11/2020	Wells Fargo Visa Card	PO99910-EMBROIDERY PATCHES-R.MOLINA'S UNIFORM	05213	Uniforms	16.00	Grants and Special Projects	GENERAL FUND
9/10/2020	Wells Fargo Visa Card	PO99910-SHIPPING-HOGG FOUNDATION CONTEST WINNERS	05211	Postage	59.09	Recreation Centers	SPECIAL REVENUES FUND
9/10/2020	Wells Fargo Visa Card	PO99910-SHIPPING-HOGG FOUNDATION CONTEST WINNERS	01251	Inter-Fund Receivable			SPECIAL REVENUES FUND
9/10/2020	Wells Fargo Visa Card	PO99910-SHIPPING-HOGG FOUNDATION CONTEST WINNERS	01251	Inter-Fund Receivable	59.09		GENERAL FUND
9/10/2020	Wells Fargo Visa Card	PO99916-SOCORRO YOUTH & CULTURE CONTEST PRIZES-IGNITE	05521	Support Activities	400.00	Recreation Centers	SPECIAL REVENUES FUND
9/10/2020	Wells Fargo Visa Card	PO99916-SOCORRO YOUTH & CULTURE CONTEST PRIZES-IGNITE	01251	Inter-Fund Receivable			SPECIAL REVENUES FUND
9/10/2020	Wells Fargo Visa Card	PO99916-SOCORRO YOUTH & CULTURE CONTEST PRIZES-IGNITE	01251	Inter-Fund Receivable	400.00		GENERAL FUND
9/10/2020	Wells Fargo Visa Card	PO99916-BOUILLON-SOCIAL MEDIA CONTENT	05521	Support Activities	29.94	Recreation Centers	GENERAL FUND
9/10/2020	Wells Fargo Visa Card	PO99916-MICROWAVE CLEANER,CORN OIL,BOUILLON-SOCIAL MEDIA CON	05521	Support Activities	57.96	Recreation Centers	GENERAL FUND
9/10/2020	Wells Fargo Visa Card	PO99916-BOUILLON-SOCIAL MEDIA CONTENT	05521	Support Activities	19.23	Recreation Centers	GENERAL FUND
9/10/2020	Wells Fargo Visa Card	PO99903-IGNITION SWITCH-PW Z MOWER JOHN DEERE	05613	Equipment Repair & Maintenance	67.07	Public Works	GENERAL FUND
9/10/2020	Wells Fargo Visa Card	PO99903-TIRES-PW28 SKID LOADER	05613	Equipment Repair & Maintenance	985.00	Public Works	GENERAL FUND

Date	Name	Transaction Description	Code	GL Description	Amount	Department	Fund
9/10/2020	Wells Fargo Visa Card	PO99902-DISINFECTING WIPES-COVID19	05900	Emergency Aid and Assistance	34.56	City Manager	CARES ACT FUND
9/10/2020	Wells Fargo Visa Card	PO99902-DISINFECTING WIPES-COVID19	01251	Inter-Fund Receivable			CARES ACT FUND
9/10/2020	Wells Fargo Visa Card	PO99902-DISINFECTING WIPES-COVID19	01251	Inter-Fund Receivable	34.56		GENERAL FUND
9/10/2020	Wells Fargo Visa Card	Office and Maintenance Supplie	05201	Office Expense and Supplies	137.33	City Manager	GENERAL FUND
9/8/2020	Wells Fargo Visa Card	PO99905-BATTERY-UNIT 1802	05612	Vehicle Repair & Maintenance	144.39	Police Department	GENERAL FUND
9/9/2020	Wells Fargo Visa Card	PO99902-BALL VALVE,HEX NIPPLE,BRASS FERRULE-SHOP COMPRESSOR	05212	Tools and Supplies	39.90	City Manager	GENERAL FUND
9/9/2020	Wells Fargo Visa Card	PO99907-WINDSHIELD PZ08	05612	Vehicle Repair & Maintenance	110.00	Planning and Zoning	GENERAL FUND
9/9/2020	Wells Fargo Visa Card	PO99903-OIL/AIR FILTERS,RING,HOLDER,RULER,BRACKET KIT,SHIELD	05613	Equipment Repair & Maintenance	62.00	Public Works	GENERAL FUND
9/9/2020	Wells Fargo Visa Card	PO99903-TIRE-PW WATER TANK LP# 967-449	05613	Equipment Repair & Maintenance	90.00	Public Works	GENERAL FUND
9/9/2020	Wells Fargo Visa Card	PO99907-WIPERS-PZ03	05612	Vehicle Repair & Maintenance	17.98	Planning and Zoning	GENERAL FUND
9/9/2020	Wells Fargo Visa Card	PO99907-WINDSHIELD GLASS-PZ03	05612	Vehicle Repair & Maintenance	110.00	Planning and Zoning	GENERAL FUND
9/8/2020	Wells Fargo Visa Card	PO99902-GLOVES-CM MECHANIC SHOP	05212	Tools and Supplies	19.98	City Manager	GENERAL FUND
9/8/2020	Wells Fargo Visa Card	PO99903-AIR/HYDRAULIC/OIL/FUEL FILTERS,U JOINT-PW66	05613	Equipment Repair & Maintenance	179.78	Public Works	GENERAL FUND
9/8/2020	Wells Fargo Visa Card	PO99902-XTREME CLEANING-860 RIO VISTA-COVID19	05311	Building & Property Maintenanc	541.45	City Manager	CARES ACT FUND
9/8/2020	Wells Fargo Visa Card	PO99902-XTREME CLEANING-860 RIO VISTA-COVID19	01251	Inter-Fund Receivable			CARES ACT FUND
9/8/2020	Wells Fargo Visa Card	PO99902-XTREME CLEANING-860 RIO VISTA-COVID19	01251	Inter-Fund Receivable	541.45		GENERAL FUND
9/9/2020	Wells Fargo Visa Card	PO99905-ALUMINUM HANDCUFF KEYS	05212	Tools and Supplies	13.58	Police Department	GENERAL FUND
9/9/2020	Wells Fargo Visa Card	PO99905-ALUMINUM HANDCUFF KEYS	01100	Accounts Receivable	1.12	Police Department	GENERAL FUND
9/9/2020	Wells Fargo Visa Card	PO99905-HARD KNUCLE FT	05212	Tools and Supplies	59.48	Police Department	GENERAL FUND
9/9/2020	Wells Fargo Visa Card	PO99905-HARD KNUCLE FT	01100	Accounts Receivable	4.91	Police Department	GENERAL FUND
9/18/2020	Wells Fargo Visa Card	PO99905-SEAT BELTS-UNITs HS80,F250	05612	Vehicle Repair & Maintenance	130.00	Police Department	GENERAL FUND

Date	Name	Transaction Description	Code	GL Description	Amount	Department	Fund
9/20/2020	Wells Fargo Visa Card	PO99907-800 NUMBER FEE-VIRTUAL MEETINGS-COVID	05314	Telephone	15.61	Planning and Zoning	CARES ACT FUND
9/20/2020	Wells Fargo Visa Card	PO99907-800 NUMBER FEE-VIRTUAL MEETINGS-COVID	01251	Inter-Fund Receivable			CARES ACT FUND
9/20/2020	Wells Fargo Visa Card	PO99907-800 NUMBER FEE-VIRTUAL MEETINGS-COVID	01251	Inter-Fund Receivable	15.61		GENERAL FUND
9/18/2020	Wells Fargo Visa Card	PO99905-CREDIT-HOTEL-TRAINING FOR OFC J. DOMINGUEZ	05711	Travel Lodg Airf Mil		Police Department	GENERAL FUND
9/18/2020	Wells Fargo Visa Card	PO99907/12/13-800 NUMBER FEE-VIRTUAL MEETINGS-COVID	05314	Telephone	16.95	Planning and Zoning	CARES ACT FUND
9/18/2020	Wells Fargo Visa Card	PO99907/12/13-800 NUMBER FEE-VIRTUAL MEETINGS-COVID	05314	Telephone	33.84	Human Resources	CARES ACT FUND
9/18/2020	Wells Fargo Visa Card	PO99907/12/13-800 NUMBER FEE-VIRTUAL MEETINGS-COVID	05314	Telephone	75.80	Mayor and City Council	CARES ACT FUND
9/18/2020	Wells Fargo Visa Card	PO99907/12/13-800 NUMBER FEE-VIRTUAL MEETINGS-COVID	01251	Inter-Fund Receivable			CARES ACT FUND
9/18/2020	Wells Fargo Visa Card	PO99907/12/13-800 NUMBER FEE-VIRTUAL MEETINGS-COVID	01251	Inter-Fund Receivable	126.59		GENERAL FUND
9/17/2020	Wells Fargo Visa Card	PO99916-CREDIT-SALES TAX	01100	Accounts Receivable		Recreation Centers	GENERAL FUND
9/17/2020	Wells Fargo Visa Card	PO99916-CREDIT-SALES TAX	01100	Accounts Receivable		Recreation Centers	GENERAL FUND
9/17/2020	Wells Fargo Visa Card	PO99916-CREDIT-SALES TAX	01100	Accounts Receivable		Recreation Centers	GENERAL FUND
9/18/2020	Wells Fargo Visa Card	PO99916-HANDLING FEE-VIDEO EDITING SOFTWARE	05201	Office Expense and Supplies	2.00	Recreation Centers	SPECIAL REVENUES FUND
9/18/2020	Wells Fargo Visa Card	PO99916-HANDLING FEE-VIDEO EDITING SOFTWARE	01251	Inter-Fund Receivable			SPECIAL REVENUES FUND
9/18/2020	Wells Fargo Visa Card	PO99916-HANDLING FEE-VIDEO EDITING SOFTWARE	01251	Inter-Fund Receivable	2.00		GENERAL FUND
9/18/2020	Wells Fargo Visa Card	PO99916-FREEZE FRAMES-VIDEO EDITING SOFTWARE	05201	Office Expense and Supplies	27.00	Recreation Centers	SPECIAL REVENUES FUND
9/18/2020	Wells Fargo Visa Card	PO99916-FREEZE FRAMES-VIDEO EDITING SOFTWARE	01251	Inter-Fund Receivable			SPECIAL REVENUES FUND
9/18/2020	Wells Fargo Visa Card	PO99916-FREEZE FRAMES-VIDEO EDITING SOFTWARE	01251	Inter-Fund Receivable	27.00		GENERAL FUND
9/18/2020	Wells Fargo Visa Card	PO99916-HANDLING FEE-VIDEO EDITING SOFTWARE	05201	Office Expense and Supplies	6.00	Recreation Centers	SPECIAL REVENUES FUND
9/18/2020	Wells Fargo Visa Card	PO99916-HANDLING FEE-VIDEO EDITING SOFTWARE	01251	Inter-Fund Receivable			SPECIAL REVENUES FUND
9/18/2020	Wells Fargo Visa Card	PO99916-HANDLING FEE-VIDEO EDITING SOFTWARE	01251	Inter-Fund Receivable	6.00		GENERAL FUND
9/18/2020	Wells Fargo Visa Card	PO99907-UNIFORMS-CODE ENFORCER S.MORALES	05213	Uniforms	344.94	Planning and Zoning	GENERAL FUND

Date	Name	Transaction Description	Code	GL Description	Amount	Department	Fund
9/18/2020	Wells Fargo Visa Card	PO99907-TAPING KNIFE, DRYWALL TROWEL, COMPOUND	05311	Building & Property Maintenance	40.77	Planning and Zoning	GENERAL FUND
9/18/2020	Wells Fargo Visa Card	PO99907-UNIFORMS-CODE ENFORCERS M.WORKMAN, S.MORALES	05213	Uniforms	315.00	Planning and Zoning	GENERAL FUND
9/18/2020	Wells Fargo Visa Card	PO99905-VEHICLE REGISTRATION RENEWAL-UNIT 2001	05612	Vehicle Repair & Maintenance	9.45	Police Department	GENERAL FUND
9/18/2020	Wells Fargo Visa Card	PO99905-VEHICLE REGISTRATION RENEWAL-UNIT 2004	05612	Vehicle Repair & Maintenance	9.45	Police Department	GENERAL FUND
9/18/2020	Wells Fargo Visa Card	PO99905-CREDIT-FRONT/REAR BRAKE PADS-UNIT 1405	05612	Vehicle Repair & Maintenance		Police Department	GENERAL FUND
9/18/2020	Wells Fargo Visa Card	PO99905-FRONT/REAR BRAKE PADS, OIL FILTER-UNIT HS80	05612	Vehicle Repair & Maintenance	96.35	Police Department	GENERAL FUND
9/23/2020	Wells Fargo Visa Card	PO99918-CONCRETE-240 N MOON	07502	Building and Facilities	664.50	Capital Projects Fund	CAPITAL PROJECTS 2019 CO's
9/23/2020	Wells Fargo Visa Card	PO99918-CONCRETE-240 N MOON	01251	Inter-Fund Receivable			CAPITAL PROJECTS 2019 CO's
9/23/2020	Wells Fargo Visa Card	PO99918-CONCRETE-240 N MOON	01251	Inter-Fund Receivable	664.50		GENERAL FUND
9/23/2020	Wells Fargo Visa Card	PO99918-CONCRETE-240 N MOON	01100	Accounts Receivable	52.50		GENERAL FUND
9/23/2020	Wells Fargo Visa Card	PO99915-FILE BOXES	05201	Office Expense and Supplies	34.50	Finance Department	GENERAL FUND
9/23/2020	Wells Fargo Visa Card	PO99905-TIRE BALANCE SVCS-PD CHIEFs UNIT	05612	Vehicle Repair & Maintenance	40.00	Police Department	GENERAL FUND
9/23/2020	Wells Fargo Visa Card	Office and Maintenance Supplies	05201	Office Expense and Supplies	35.97	City Manager	GENERAL FUND
9/23/2020	Wells Fargo Visa Card	PO99903-OIL FILTER, AIR FILTER-PW28 SKID LOADER	05613	Equipment Repair & Maintenance	26.36	Public Works	GENERAL FUND
9/23/2020	Wells Fargo Visa Card	PO99903-TIRE-PW43 DISTRIBUTOR	05613	Equipment Repair & Maintenance	85.00	Public Works	GENERAL FUND
9/22/2020	Wells Fargo Visa Card	PO99915-FILE FOLDERS, POST IT NOTES	05201	Office Expense and Supplies	11.19	Finance Department	GENERAL FUND
9/22/2020	Wells Fargo Visa Card	PO99907-WALL REPAIR SUPPLIES	05311	Building & Property Maintenance	29.99	Planning and Zoning	GENERAL FUND
9/22/2020	Wells Fargo Visa Card	PO99910-MONTHLY SUBSCRIPTION-ADOBE ILLUSTRATOR	05516	Dues/Subscriptions	20.99	Grants and Special Projects	GENERAL FUND
9/22/2020	Wells Fargo Visa Card	PO99903-BATTERY-PW20 NEW HOLLAND TRACTOR	05613	Equipment Repair & Maintenance	139.99	Public Works	GENERAL FUND
9/16/2020	Wells Fargo Visa Card	PO99905-ROCK-LANDSCAPING AT 240 N MOON	07502	Building and Facilities	463.98	Capital Projects Fund	CAPITAL PROJECTS 2019 CO's
9/16/2020	Wells Fargo Visa Card	PO99905-ROCK-LANDSCAPING AT 240 N MOON	01251	Inter-Fund Receivable			CAPITAL PROJECTS 2019 CO's
9/16/2020	Wells Fargo Visa Card	PO99905-ROCK-LANDSCAPING AT 240 N MOON	01251	Inter-Fund Receivable	463.98		GENERAL FUND

Date	Name	Transaction Description	Code	GL Description	Amount	Department	Fund
9/16/2020	Wells Fargo Visa Card	PO99905-ROCK-LANDSCAPING AT 240 N MOON	07502	Building and Facilities	449.54	Capital Projects Fund	CAPITAL PROJECTS 2019 CO's
9/16/2020	Wells Fargo Visa Card	PO99905-ROCK-LANDSCAPING AT 240 N MOON	01251	Inter-Fund Receivable			CAPITAL PROJECTS 2019 CO's
9/16/2020	Wells Fargo Visa Card	PO99905-ROCK-LANDSCAPING AT 240 N MOON	01251	Inter-Fund Receivable	449.54		GENERAL FUND
9/16/2020	Wells Fargo Visa Card	PO99905-ROCK-LANDSCAPING AT 240 N MOON	07502	Building and Facilities	447.64	Capital Projects Fund	CAPITAL PROJECTS 2019 CO's
9/16/2020	Wells Fargo Visa Card	PO99905-ROCK-LANDSCAPING AT 240 N MOON	01251	Inter-Fund Receivable			CAPITAL PROJECTS 2019 CO's
9/16/2020	Wells Fargo Visa Card	PO99905-ROCK-LANDSCAPING AT 240 N MOON	01251	Inter-Fund Receivable	447.64		GENERAL FUND
9/16/2020	Wells Fargo Visa Card	PO99905-ROCK-LANDSCAPING AT 240 N MOON	07502	Building and Facilities	449.16	Capital Projects Fund	CAPITAL PROJECTS 2019 CO's
9/16/2020	Wells Fargo Visa Card	PO99905-ROCK-LANDSCAPING AT 240 N MOON	01251	Inter-Fund Receivable			CAPITAL PROJECTS 2019 CO's
9/16/2020	Wells Fargo Visa Card	PO99905-ROCK-LANDSCAPING AT 240 N MOON	01251	Inter-Fund Receivable	449.16		GENERAL FUND
9/17/2020	Wells Fargo Visa Card	PO99905-ROCK-LANDSCAPING AT 240 N MOON	07502	Building and Facilities	459.04	Capital Projects Fund	CAPITAL PROJECTS 2019 CO's
9/17/2020	Wells Fargo Visa Card	PO99905-ROCK-LANDSCAPING AT 240 N MOON	01251	Inter-Fund Receivable			CAPITAL PROJECTS 2019 CO's
9/17/2020	Wells Fargo Visa Card	PO99905-ROCK-LANDSCAPING AT 240 N MOON	01251	Inter-Fund Receivable	459.04		GENERAL FUND
9/17/2020	Wells Fargo Visa Card	PO99910-SHIPPING-HOGG FOUNDATION CONTEST WINNERS	05211	Postage	25.17	Recreation Centers	SPECIAL REVENUES FUND
9/17/2020	Wells Fargo Visa Card	PO99910-SHIPPING-HOGG FOUNDATION CONTEST WINNERS	01251	Inter-Fund Receivable			SPECIAL REVENUES FUND
9/17/2020	Wells Fargo Visa Card	PO99910-SHIPPING-HOGG FOUNDATION CONTEST WINNERS	01251	Inter-Fund Receivable	25.17		GENERAL FUND
9/17/2020	Wells Fargo Visa Card	PO99916-FLOURESCENT LIGHT BULBS	05311	Building & Property Maintenanc	63.57	Recreation Centers	GENERAL FUND
9/17/2020	Wells Fargo Visa Card	Building & Property Supplies	05311	Building & Property Maintenanc	162.00	City Manager	GENERAL FUND
9/17/2020	Wells Fargo Visa Card	PO99907-BUSINESS CARDS-R.SERAFIN,J.RODRIGUEZ,C.HOLGUIN	05201	Office Expense and Supplies	115.44	Planning and Zoning	GENERAL FUND
9/17/2020	Wells Fargo Visa Card	PO99905-ONLINE TRNG FOR SEVERAL OFFICERS	05527	Seminars/Training/Workshops	530.00	Police Department	GENERAL FUND
9/17/2020	Wells Fargo Visa Card	PO99905-ONLINE TRNG FOR OFC PEREZ	05527	Seminars/Training/Workshops	40.00	Police Department	GENERAL FUND
9/17/2020	Wells Fargo Visa Card	PO99905-ONLINE TRNG FOR SEVERAL OFFICERS	05527	Seminars/Training/Workshops	125.00	Police Department	GENERAL FUND
9/17/2020	Wells Fargo Visa Card	PO99905-ONLINE TRNG FOR SEVERAL OFFICERS	05527	Seminars/Training/Workshops	850.00	Police Department	GENERAL FUND

Date	Name	Transaction Description	Code	GL Description	Amount	Department	Fund
9/17/2020	Wells Fargo Visa Card	PO99902-MALE ADAPTERS,COUPLINGS,ELBOWS,NIPPLES	05212	Tools and Supplies	17.74	City Manager	GENERAL FUND
9/17/2020	Wells Fargo Visa Card	PO99905-TRANSMISSION MOUNT UNIT 1405	05612	Vehicle Repair & Maintenance	120.81	Police Department	GENERAL FUND
9/17/2020	Wells Fargo Visa Card	PO99905-LEFT/RIGHT CONTROL ARMS UNIT 1405	05612	Vehicle Repair & Maintenance	219.64	Police Department	GENERAL FUND
9/17/2020	Wells Fargo Visa Card	PO99905-FRONT/REAR BRAKE PADS,ENGINE MOTOR MOUNT-UNIT 1405	05612	Vehicle Repair & Maintenance	91.57	Police Department	GENERAL FUND
9/15/2020	Wells Fargo Visa Card	PO99905-WEBCAM,MOUNTING BRACKET,CAMERA CASE,SCANNER	05201	Office Expense and Supplies	307.96	Police Department	SPECIAL REVENUES FUND
9/15/2020	Wells Fargo Visa Card	PO99905-WEBCAM,MOUNTING BRACKET,CAMERA CASE,SCANNER	01251	Inter-Fund Receivable			SPECIAL REVENUES FUND
9/15/2020	Wells Fargo Visa Card	PO99905-WEBCAM,MOUNTING BRACKET,CAMERA CASE,SCANNER	01251	Inter-Fund Receivable	307.96		GENERAL FUND
9/15/2020	Wells Fargo Visa Card	PO99905-TIRE REPAIR UNIT 1602	05612	Vehicle Repair & Maintenance	30.00	Police Department	GENERAL FUND
9/15/2020	Wells Fargo Visa Card	PO99905-MOTOR OIL UNIT 1602	05612	Vehicle Repair & Maintenance	111.24	Police Department	GENERAL FUND
9/15/2020	Wells Fargo Visa Card	PO99905-CREDIT-TRANSMISSION MOUNT UNIT 1405	05612	Vehicle Repair & Maintenance		Police Department	GENERAL FUND
9/15/2020	Wells Fargo Visa Card	PO99905-FABRIC FOR ROCK-LANDSCAPING AT 240 N MOON	07502	Building and Facilities	860.00	Capital Projects Fund	CAPITAL PROJECTS 2019 CO's
9/15/2020	Wells Fargo Visa Card	PO99905-FABRIC FOR ROCK-LANDSCAPING AT 240 N MOON	01251	Inter-Fund Receivable			CAPITAL PROJECTS 2019 CO's
9/15/2020	Wells Fargo Visa Card	PO99905-FABRIC FOR ROCK-LANDSCAPING AT 240 N MOON	01251	Inter-Fund Receivable	860.00		GENERAL FUND
9/15/2020	Wells Fargo Visa Card	PO99905-FABRIC FOR ROCK-LANDSCAPING AT 240 N MOON	07502	Building and Facilities	60.00	Capital Projects Fund	CAPITAL PROJECTS 2019 CO's
9/15/2020	Wells Fargo Visa Card	PO99905-FABRIC FOR ROCK-LANDSCAPING AT 240 N MOON	01251	Inter-Fund Receivable			CAPITAL PROJECTS 2019 CO's
9/15/2020	Wells Fargo Visa Card	PO99905-FABRIC FOR ROCK-LANDSCAPING AT 240 N MOON	01251	Inter-Fund Receivable	60.00		GENERAL FUND
9/15/2020	Wells Fargo Visa Card	PO99918-BLOCKS FOR LANDSCAPING-240 N MOON	07502	Building and Facilities	89.92	Capital Projects Fund	CAPITAL PROJECTS 2019 CO's
9/15/2020	Wells Fargo Visa Card	PO99918-BLOCKS FOR LANDSCAPING-240 N MOON	01251	Inter-Fund Receivable			CAPITAL PROJECTS 2019 CO's
9/15/2020	Wells Fargo Visa Card	PO99918-BLOCKS FOR LANDSCAPING-240 N MOON	01251	Inter-Fund Receivable	89.92		GENERAL FUND
9/16/2020	Wells Fargo Visa Card	PO99916-LIQUID HAND SOAP REFILLS	05201	Office Expense and Supplies	90.36	Recreation Centers	GENERAL FUND
9/16/2020	Wells Fargo Visa Card	PO99916-CREDIT-MONDAY.COM YEARLY SUBSCRIPTION	05516	Dues/Subscriptions		Recreation Centers	GENERAL FUND
9/16/2020	Wells Fargo Visa Card	PO99916-CREDIT-MONDAY.COM YEARLY SUBSCRIPTION	01100	Accounts Receivable		Recreation Centers	GENERAL FUND

Date	Name	Transaction Description	Code	GL Description	Amount	Department	Fund
9/16/2020	Wells Fargo Visa Card	PO99916-CREDIT-MONDAY.COM YEARLY SUBSCRIPTION	05516	Dues/Subscriptions		Recreation Centers	GENERAL FUND
9/16/2020	Wells Fargo Visa Card	PO99916-CREDIT-MONDAY.COM YEARLY SUBSCRIPTION	01100	Accounts Receivable		Recreation Centers	GENERAL FUND
9/16/2020	Wells Fargo Visa Card	PO99925-CREDIT-CITY WEBSITE RENEWAL	05520	Service Contracts		Information Technology	GENERAL FUND
9/16/2020	Wells Fargo Visa Card	PO99925-CREDIT-CITY WEBSITE RENEWAL	01100	Accounts Receivable		Information Technology	GENERAL FUND
9/16/2020	Wells Fargo Visa Card	PO99915-LENOVO TOWER,WIN PRO10 LICENSE,SSD HARD DRIVE	05810	Property and Equipment	959.97	Finance Department	GENERAL FUND
9/16/2020	Wells Fargo Visa Card	PO99903-CHUTES,FAN-PW Z MOWERS JDEERE	05613	Equipment Repair & Maintenance	255.70	Public Works	GENERAL FUND
9/16/2020	Wells Fargo Visa Card	PO99903-PADLOCKS,CHAIN	05311	Building & Property Maintenanc	53.96	Public Works	GENERAL FUND
9/16/2020	Wells Fargo Visa Card	Office and Maintenance Supplie	05201	Office Expense and Supplies	292.20	City Manager	GENERAL FUND
9/16/2020	Wells Fargo Visa Card	PO99925-WEBCAMS W/BUILT IN MIC	05810	Property and Equipment	71.98	Information Technology	GENERAL FUND
9/16/2020	Wells Fargo Visa Card	PO99905-ONLINE TRNG FOR SEVERAL OFFICERS	05527	Seminars/Training/Workshops	695.00	Police Department	GENERAL FUND
9/16/2020	Wells Fargo Visa Card	PO99905-ONLINE TRN-OFC BURCIAGA	05527	Seminars/Training/Workshops	202.50	Police Department	GENERAL FUND
9/16/2020	Wells Fargo Visa Card	PO99905-ONLINE TRNG FOR SEVERAL OFFICERS	05527	Seminars/Training/Workshops	210.00	Police Department	GENERAL FUND
9/16/2020	Wells Fargo Visa Card	PO99905-ONLINE TRNG FOR SEVERAL OFFICERS	05527	Seminars/Training/Workshops	240.00	Police Department	GENERAL FUND
9/16/2020	Wells Fargo Visa Card	PO99905-UNIFORM PANTS FOR NEW OFFICERS	05213	Uniforms	182.90	Police Department	GENERAL FUND
9/16/2020	Wells Fargo Visa Card	PO99905-ONLINE TRNG FOR SEVERAL OFFICERS	05527	Seminars/Training/Workshops	60.00	Police Department	GENERAL FUND
9/16/2020	Wells Fargo Visa Card	PO99905-ONLINE TRNG FOR SEVERAL OFFICERS	05527	Seminars/Training/Workshops	600.00	Police Department	GENERAL FUND
9/16/2020	Wells Fargo Visa Card	PO99905-ONLINE TRNG FOR SEVERAL OFFICERS	05527	Seminars/Training/Workshops	120.00	Police Department	GENERAL FUND
9/16/2020	Wells Fargo Visa Card	PO99905-ONLINE TRNG FOR SEVERAL OFFICERS	05527	Seminars/Training/Workshops	155.00	Police Department	GENERAL FUND
9/16/2020	Wells Fargo Visa Card	PO99905-ONLINE TRNG FOR SEVERAL OFFICERS	05527	Seminars/Training/Workshops	50.00	Police Department	GENERAL FUND
9/16/2020	Wells Fargo Visa Card	PO99905-ONLINE TRNG-CRIME VICTIM ADVOCATE L. ELIAS	05527	Seminars/Training/Workshops	30.00	Police Department	SPECIAL REVENUES FUND
9/16/2020	Wells Fargo Visa Card	PO99905-ONLINE TRNG-CRIME VICTIM ADVOCATE L. ELIAS	01251	Inter-Fund Receivable			SPECIAL REVENUES FUND
9/16/2020	Wells Fargo Visa Card	PO99905-ONLINE TRNG-CRIME VICTIM ADVOCATE L. ELIAS	01251	Inter-Fund Receivable	30.00		GENERAL FUND

Date	Name	Transaction Description	Code	GL Description	Amount	Department	Fund
9/16/2020	Wells Fargo Visa Card	PO99905-LICENSE PLATE BRACKETS-NEW FUSION UNITS	05612	Vehicle Repair & Maintenance	11.98	Police Department	GENERAL FUND
9/16/2020	Wells Fargo Visa Card	PO99905-LICENSE PLATE BRACKETS-NEW FUSION UNITS	05612	Vehicle Repair & Maintenance	11.98	Police Department	GENERAL FUND
9/24/2020	Wells Fargo Visa Card	PO99903-2 STROKE OIL,BRAKE CLEANER-PW TRIMMERS	05613	Equipment Repair & Maintenance	57.74	Public Works	GENERAL FUND
9/24/2020	Wells Fargo Visa Card	PO99903-TRAYS,POPCORN BAGS,COOKIES,BEVERAGES-COMMUNITY CLEAN	05325	Recycling Center	139.90	Public Works	GENERAL FUND
9/24/2020	Wells Fargo Visa Card	PO99903-BREAKFAST SUPPLIES-COMMUNITY CLEAN UP	05325	Recycling Center	65.40	Public Works	GENERAL FUND
9/25/2020	Wells Fargo Visa Card	PO99916-CENSUS MARKETING MATERIALS	05511	Advertising/Drug Testing	50.00	Recreation Centers	SPECIAL REVENUES FUND
9/25/2020	Wells Fargo Visa Card	PO99916-CENSUS MARKETING MATERIALS	01251	Inter-Fund Receivable			SPECIAL REVENUES FUND
9/25/2020	Wells Fargo Visa Card	PO99916-CENSUS MARKETING MATERIALS	01251	Inter-Fund Receivable	50.00		GENERAL FUND
9/25/2020	Wells Fargo Visa Card	PO99925-UNIFORM PANTS	05213	Uniforms	67.14	Information Technology	GENERAL FUND
9/25/2020	Wells Fargo Visa Card	PO99905-VEHICLE REGISTRATION RENEWALS-UNITs 1601, 1602	05612	Vehicle Repair & Maintenance	20.50	Police Department	GENERAL FUND
9/24/2020	Wells Fargo Visa Card	PO99905-WINDSHIELD WASHER FLUID FOR ALL PD UNITS	05612	Vehicle Repair & Maintenance	24.95	Police Department	GENERAL FUND
9/24/2020	Wells Fargo Visa Card	Office and Maintenance Supplie	05201	Office Expense and Supplies	24.66	City Manager	GENERAL FUND
9/24/2020	Wells Fargo Visa Card	Office and Maintenance Supplie	05201	Office Expense and Supplies	15.44	City Manager	GENERAL FUND
9/24/2020	Wells Fargo Visa Card	PO25064-PAPER TOWELS-CM	05201	Office Expense and Supplies	17.54	City Manager	GENERAL FUND
9/24/2020	Wells Fargo Visa Card	PO25064-PAPER TOWELS-CM	05201	Office Expense and Supplies	32.98	City Manager	GENERAL FUND
9/24/2020	Wells Fargo Visa Card	PO99905-HOTEL-BASIC SWAT TRNG-OFC J.DOMINGUEZ 9/28-10/2/20	05711	Travel Lodg Airf Mil	856.70	Police Department	GENERAL FUND
9/29/2020	Wells Fargo Visa Card	PO99905-TIRE BALANCE-UNIT 1400	05612	Vehicle Repair & Maintenance	20.00	Police Department	GENERAL FUND
9/29/2020	Wells Fargo Visa Card	PO99903-OIL FILTER,MOTOR OIL-PW08	05612	Vehicle Repair & Maintenance	44.27	Public Works	GENERAL FUND
9/30/2020	Wells Fargo Visa Card	PO99907-MEASURING TAPE,GLOVES,WIRE,PLIERS,VESTS,KNIFE,WRECKI	05212	Tools and Supplies	175.86	Planning and Zoning	GENERAL FUND
9/30/2020	Wells Fargo Visa Card	PO99916-CENSUS CAMPAING RADIO ANNOUNCEMENTS	05511	Advertising/Drug Testing	176.00	Recreation Centers	SPECIAL REVENUES FUND
9/30/2020	Wells Fargo Visa Card	PO99916-CENSUS CAMPAING RADIO ANNOUNCEMENTS	01251	Inter-Fund Receivable			SPECIAL REVENUES FUND

Date	Name	Transaction Description	Code	GL Description	Amount	Department	Fund
9/30/2020	Wells Fargo Visa Card	PO99916-CENSUS CAMPAING RADIO ANNOUNCEMENTS	01251	Inter-Fund Receivable	176.00		GENERAL FUND
9/30/2020	Wells Fargo Visa Card	PO99903-RESURFACE BRAKE ROTORS-PW08	05612	Vehicle Repair & Maintenance	40.00	Public Works	GENERAL FUND
9/30/2020	Wells Fargo Visa Card	PO99903-WRENCH SET	05212	Tools and Supplies	54.99	Public Works	GENERAL FUND
9/30/2020	Wells Fargo Visa Card	PO99903-AIR FILTER,BRAKE PADS,WIPERS,BULBS,DEODORIZERS	05612	Vehicle Repair & Maintenance	121.72	Public Works	GENERAL FUND
9/26/2020	Wells Fargo Visa Card	PO99903-MEASURING TAPE,PICK REPAIR SET,CIRCUIT TESTER,FLUX W	05212	Tools and Supplies	335.92	Public Works	GENERAL FUND
9/28/2020	Wells Fargo Visa Card	PO99902-XTREME CLEANING-860 RIO VISTA-COVID19	05311	Building & Property Maintenanc	541.45	City Manager	CARES ACT FUND
9/28/2020	Wells Fargo Visa Card	PO99902-XTREME CLEANING-860 RIO VISTA-COVID19	01251	Inter-Fund Receivable			CARES ACT FUND
9/28/2020	Wells Fargo Visa Card	PO99902-XTREME CLEANING-860 RIO VISTA-COVID19	01251	Inter-Fund Receivable	541.45		GENERAL FUND
9/28/2020	Wells Fargo Visa Card	PO99903-OIL/FILTER,GEAR OIL,BEARING CUP/COIL,OIL SEAL-PW05	05612	Vehicle Repair & Maintenance	61.02	Public Works	GENERAL FUND
9/28/2020	Wells Fargo Visa Card	PO99903-RESURFACE BRAKE ROTORS-PW05	05612	Vehicle Repair & Maintenance	40.00	Public Works	GENERAL FUND
9/28/2020	Wells Fargo Visa Card	PO99903-BRAKE/STOP LIGHTS,WIPERS,ADHESIVE REMOVER,GASKET MAT	05613	Equipment Repair & Maintenance	109.61	Public Works	GENERAL FUND
9/28/2020	Wells Fargo Visa Card	PO99903-V BELT-PW05	05612	Vehicle Repair & Maintenance	28.99	Public Works	GENERAL FUND
9/28/2020	Wells Fargo Visa Card	PO99903-BRUSH SET,SDRVR ATTACHMENT,GOO GONE,TORCH,SOAPSTONES	05212	Tools and Supplies	90.33	Public Works	GENERAL FUND
9/29/2020	Wells Fargo Visa Card	PO99912-BIRTHDAY CARDS-EMPLOYEE BIRTHDAYS	05521	Support Activities	25.00	Human Resources	GENERAL FUND
9/29/2020	Wells Fargo Visa Card	PO99916-MONTHLY PEST CONTROL SVCS-CACC	05311	Building & Property Maintenanc	40.00	Recreation Centers	GENERAL FUND
9/30/2020	West Government Services	PO99905-CONTRACT CHARGES FOR CLEAR FOR SEP 2020	05520	Service Contracts	521.65	Police Department	GENERAL FUND
9/25/2020	WESTERN REFINERY	Fuel	01206	Gas Inventory	6,830.12	Public Works	GENERAL FUND
9/1/2020	X Cleaning Professionals, LLC	PO99902-CREDIT-XTREME CLEANING-860 RIO VISTA-COVID19	05311	Building & Property Maintenanc		City Manager	GENERAL FUND
Total Accounts Payable Transactions					\$ 696,750.49		

Elia Garcia
Mayor
Rene Rodriguez
At Large
Cesar Nevarez
District 1/ Mayor Pro Tem



Ralph Duran
District 2
Victor Perez
District 3
Yvonne Colon-Villalobos
District 4
Adriana Rodarte
City Manager

DATE: October 29, 2020

TO: MAYOR AND CITY COUNCIL MEMBERS

FROM: Charles Casiano, Finance Director

SUBJECT: Discussion and action on approving September 2020 cash receipts report.

SUMMARY

The cash receipts report summarizes all of the departmental deposits for September 2020. This report does not include any wire transfers into our accounts or adjusting journal entries.

STATEMENT OF THE ISSUE

FINANCIAL IMPACT

ALTERNATIVE

STAFF RECOMMENDATION

**City of Socorro
Cash Receipts Report
September 2020**

Effective Date	Name	Transaction Description	GL Code	GL Title	FUND Code	CITY DEPARTMENT Code	Debit	Credit	GRANT/PROGRAM Short Title	FUND Title
9/1/2020	Municipal Court-City of Socorr	PST CR FOR MC SEP2020 145188-	01010	Wells Fargo-M&O	001	00006	154.00		Non grant item	GENERAL FUND
9/1/2020	Municipal Court-City of Socorr	PST CR FOR MC SEP2020 145188-	01010		001	00006	5,771.80			
9/1/2020	Municipal Court-City of Socorr	PST CR FOR MC SEP2020 145188-	02115	State Fees Payable	001	00006		1,258.60	STATE FEE	GENERAL FUND
9/1/2020	Municipal Court-City of Socorr	PST CR FOR MC SEP2020 145188-	04507	Muni. Court Judgements/Fines	001	00006		680.60	CITY FEE	GENERAL FUND
9/1/2020	Municipal Court-City of Socorr	PST CR FOR MC SEP2020 145188-	02613	OMNI Collections	001	00006		60.00	Omnibase Fee	GENERAL FUND
9/1/2020	Municipal Court-City of Socorr	PST CR FOR MC SEP2020 145188-	04507	Muni. Court Judgements/Fines	001	00006		18.00	Court Bldg. Sec	GENERAL FUND
9/1/2020	Municipal Court-City of Socorr	PST CR FOR MC SEP2020 145188-	02617	Collection Agency COLL	001	00006		1,048.34	Collection Agen	GENERAL FUND
9/1/2020	Municipal Court-City of Socorr	PST CR FOR MC SEP2020 145188-	04507	Muni. Court Judgements/Fines	001	00006		2,696.18	CITY FINE	GENERAL FUND
9/1/2020	Municipal Court-City of Socorr	PST CR FOR MC SEP2020 145188-	04511	Juvenile Case Management Fee	001	00006		30.00	JUV CASE MGMT F	GENERAL FUND
9/1/2020	Municipal Court-City of Socorr	PST CR FOR MC SEP2020 145188-	04511		001	00006		6.00	TRUANCY PREVENT	GENERAL FUND
9/1/2020	Municipal Court-City of Socorr	PST CR FOR MC SEP2020 145188-	04512	Municipal Court Technology	001	00006		24.00	Court Tech Fund	GENERAL FUND
9/1/2020	Municipal Court-City of Socorr	PST CR FOR MC SEP2020 145188-	04507	Muni. Court Judgements/Fines	001	00006		36.43	LCF1 Security	GENERAL FUND
9/1/2020	Municipal Court-City of Socorr	PST CR FOR MC SEP2020 145188-	04507		001	00006		37.18	LCF2 Truancy	GENERAL FUND
9/1/2020	Municipal Court-City of Socorr	PST CR FOR MC SEP2020 145188-	04507		001	00006		29.73	LCF3 - Tech	GENERAL FUND
9/1/2020	Municipal Court-City of Socorr	PST CR FOR MC SEP2020 145188-	04507		001	00006		0.74	LCF4 - Jury	GENERAL FUND
9/1/2020	Planning Dept -City of Socorro	PST CR FOR PZ SEP 2020 RECPT.33738-	01010	Wells Fargo-M&O	001	00007	3,104.35		Non grant item	GENERAL FUND
9/1/2020	Planning Dept -City of Socorro	PST CR FOR PZ SEP 2020 RECPT.33738-	04501	Building Permits	001	00007		3,104.35	Non grant item	GENERAL FUND

**City of Socorro
Cash Receipts Report
September 2020**

Effective Date	Name	Transaction Description	GL Code	GL Title	FUND Code	CITY DEPARTMENT Code	Debit	Credit	GRANT/PROGRAM Short Title	FUND Title
9/2/2020	Municipal Court-City of Socorr	PST CR FOR MC SEP2020 145218-	01010	Wells Fargo-M&O	001	00006	432.00		Non grant item	GENERAL FUND
9/2/2020	Municipal Court-City of Socorr	PST CR FOR MC SEP2020 145218-	01010		001	00006	1,047.10			
9/2/2020	Municipal Court-City of Socorr	PST CR FOR MC SEP2020 145218-	02115	State Fees Payable	001	00006		884.90	STATE FEE	GENERAL FUND
9/2/2020	Municipal Court-City of Socorr	PST CR FOR MC SEP2020 145218-	04507	Muni. Court Judgements/Fines	001	00006		218.06	CITY FEE	GENERAL FUND
9/2/2020	Municipal Court-City of Socorr	PST CR FOR MC SEP2020 145218-	02613	OMNI Collections	001	00006		72.00	Omnibase Fee	GENERAL FUND
9/2/2020	Municipal Court-City of Socorr	PST CR FOR MC SEP2020 145218-	04507	Muni. Court Judgements/Fines	001	00006		3.79	Court Bldg. Sec	GENERAL FUND
9/2/2020	Municipal Court-City of Socorr	PST CR FOR MC SEP2020 145218-	04507		001	00006		230.67	CITY FINE	GENERAL FUND
9/2/2020	Municipal Court-City of Socorr	PST CR FOR MC SEP2020 145218-	04511	Juvenile Case Management Fee	001	00006		6.31	JUV CASE MGMT F	GENERAL FUND
9/2/2020	Municipal Court-City of Socorr	PST CR FOR MC SEP2020 145218-	04511		001	00006		2.00	TRUANCY PREVENT	GENERAL FUND
9/2/2020	Municipal Court-City of Socorr	PST CR FOR MC SEP2020 145218-	04512	Municipal Court Technology	001	00006		5.04	Court Tech Fund	GENERAL FUND
9/2/2020	Municipal Court-City of Socorr	PST CR FOR MC SEP2020 145218-	04507	Muni. Court Judgements/Fines	001	00006		19.71	LCF1 Security	GENERAL FUND
9/2/2020	Municipal Court-City of Socorr	PST CR FOR MC SEP2020 145218-	04507		001	00006		20.11	LCF2 Truancy	GENERAL FUND
9/2/2020	Municipal Court-City of Socorr	PST CR FOR MC SEP2020 145218-	04507		001	00006		16.09	LCF3 - Tech	GENERAL FUND
9/2/2020	Municipal Court-City of Socorr	PST CR FOR MC SEP2020 145218-	04507		001	00006		0.42	LCF4 - Jury	GENERAL FUND
9/2/2020	Planning Dept -City of Socorro	PST CR FOR PZ SEP 2020 RECPT.33746-	01010	Wells Fargo-M&O	001	00007	887.50		Non grant item	GENERAL FUND
9/2/2020	Planning Dept -City of Socorro	PST CR FOR PZ SEP 2020 RECPT.33746-	01010		001	00007	85.00			
9/2/2020	Planning Dept -City of Socorro	PST CR FOR PZ SEP 2020 RECPT.33746-	04501	Building Permits	001	00007		710.00	Non grant item	GENERAL FUND

**City of Socorro
Cash Receipts Report
September 2020**

Effective Date	Name	Transaction Description	GL Code	GL Title	FUND Code	CITY DEPARTMENT Code	Debit	Credit	GRANT/PROGRAM Short Title	FUND Title
9/2/2020	Planning Dept -City of Socorro	PST CR FOR PZ SEP 2020 RECPT.33746-	04502	Business Registration	001	00007		262.50	Non grant item	GENERAL FUND
9/3/2020	Municipal Court-City of Socorr	PST CR FOR MC SEP2020 145250-	01010	Wells Fargo-M&O	001	00006	379.00		Non grant item	GENERAL FUND
9/3/2020	Municipal Court-City of Socorr	PST CR FOR MC SEP2020 145250-	01010		001	00006	1,915.10			
9/3/2020	Municipal Court-City of Socorr	PST CR FOR MC SEP2020 145250-	02115	State Fees Payable	001	00006		1,029.50	STATE FEE	GENERAL FUND
9/3/2020	Municipal Court-City of Socorr	PST CR FOR MC SEP2020 145250-	04507	Muni. Court Judgements/Fines	001	00006		292.60	CITY FEE	GENERAL FUND
9/3/2020	Municipal Court-City of Socorr	PST CR FOR MC SEP2020 145250-	04507		001	00006		3.00	Court Bldg. Sec	GENERAL FUND
9/3/2020	Municipal Court-City of Socorr	PST CR FOR MC SEP2020 145250-	04507		001	00006		833.00	CITY FINE	GENERAL FUND
9/3/2020	Municipal Court-City of Socorr	PST CR FOR MC SEP2020 145250-	04511	Juvenile Case Management Fee	001	00006		5.00	JUV CASE MGMT F	GENERAL FUND
9/3/2020	Municipal Court-City of Socorr	PST CR FOR MC SEP2020 145250-	04511		001	00006		1.00	TRUANCY PREVENT	GENERAL FUND
9/3/2020	Municipal Court-City of Socorr	PST CR FOR MC SEP2020 145250-	04512	Municipal Court Technology	001	00006		4.00	Court Tech Fund	GENERAL FUND
9/3/2020	Municipal Court-City of Socorr	PST CR FOR MC SEP2020 145250-	04507	Muni. Court Judgements/Fines	001	00006		44.10	LCF1 Security	GENERAL FUND
9/3/2020	Municipal Court-City of Socorr	PST CR FOR MC SEP2020 145250-	04507		001	00006		45.00	LCF2 Truancy	GENERAL FUND
9/3/2020	Municipal Court-City of Socorr	PST CR FOR MC SEP2020 145250-	04507		001	00006		36.00	LCF3 - Tech	GENERAL FUND
9/3/2020	Municipal Court-City of Socorr	PST CR FOR MC SEP2020 145250-	04507		001	00006		0.90	LCF4 - Jury	GENERAL FUND
9/3/2020	Planning Dept -City of Socorro	PST CR FOR PZ SEP 2020 RECPT.33758-	01010	Wells Fargo-M&O	001	00007	855.84		Non grant item	GENERAL FUND
9/3/2020	Planning Dept -City of Socorro	PST CR FOR PZ SEP 2020 RECPT.33758-	04501	Building Permits	001	00007		430.84	Non grant item	GENERAL FUND
9/3/2020	Planning Dept -City of Socorro	PST CR FOR PZ SEP 2020 RECPT.33758-	04502	Business Registration	001	00007		425.00	Non grant item	GENERAL FUND

**City of Socorro
Cash Receipts Report
September 2020**

Effective Date	Name	Transaction Description	GL Code	GL Title	FUND Code	CITY DEPARTMENT Code	Debit	Credit	GRANT/PROGRAM Short Title	FUND Title
9/4/2020	Municipal Court-City of Socorr	PST CR FOR MC SEP2020 145321-	01010	Wells Fargo-M&O	001	00006	2,180.00		Non grant item	GENERAL FUND
9/4/2020	Municipal Court-City of Socorr	PST CR FOR MC SEP2020 145321-	01010		001	00006	3,302.70			
9/4/2020	Municipal Court-City of Socorr	PST CR FOR MC SEP2020 145321-	02115	State Fees Payable	001	00006		1,648.64	STATE FEE	GENERAL FUND
9/4/2020	Municipal Court-City of Socorr	PST CR FOR MC SEP2020 145321-	04507	Muni. Court Judgements/Fines	001	00006		662.30	CITY FEE	GENERAL FUND
9/4/2020	Municipal Court-City of Socorr	PST CR FOR MC SEP2020 145321-	02613	OMNI Collections	001	00006		56.63	Omnibase Fee	GENERAL FUND
9/4/2020	Municipal Court-City of Socorr	PST CR FOR MC SEP2020 145321-	04507	Muni. Court Judgements/Fines	001	00006		18.00	Court Bldg. Sec	GENERAL FUND
9/4/2020	Municipal Court-City of Socorr	PST CR FOR MC SEP2020 145321-	02617	Collection Agency COLL	001	00006		640.50	Collection Agen	GENERAL FUND
9/4/2020	Municipal Court-City of Socorr	PST CR FOR MC SEP2020 145321-	02126	Child Safety Seat/Belt Fines	001	00006		123.75	ChildSftySeat/B	GENERAL FUND
9/4/2020	Municipal Court-City of Socorr	PST CR FOR MC SEP2020 145321-	04507	Muni. Court Judgements/Fines	001	00006		123.75	ChildSftySeat/B	GENERAL FUND
9/4/2020	Municipal Court-City of Socorr	PST CR FOR MC SEP2020 145321-	04507		001	00006		2,007.87	CITY FINE	GENERAL FUND
9/4/2020	Municipal Court-City of Socorr	PST CR FOR MC SEP2020 145321-	04511	Juvenile Case Management Fee	001	00006		20.00	JUV CASE MGMT F	GENERAL FUND
9/4/2020	Municipal Court-City of Socorr	PST CR FOR MC SEP2020 145321-	04511		001	00006		5.43	TRUANCY PREVENT	GENERAL FUND
9/4/2020	Municipal Court-City of Socorr	PST CR FOR MC SEP2020 145321-	04512	Municipal Court Technology	001	00006		24.00	Court Tech Fund	GENERAL FUND
9/4/2020	Municipal Court-City of Socorr	PST CR FOR MC SEP2020 145321-	04507	Muni. Court Judgements/Fines	001	00006		53.15	LCF1 Security	GENERAL FUND
9/4/2020	Municipal Court-City of Socorr	PST CR FOR MC SEP2020 145321-	04507		001	00006		54.24	LCF2 Truancy	GENERAL FUND
9/4/2020	Municipal Court-City of Socorr	PST CR FOR MC SEP2020 145321-	04507		001	00006		43.39	LCF3 - Tech	GENERAL FUND
9/4/2020	Municipal Court-City of Socorr	PST CR FOR MC SEP2020 145321-	04507		001	00006		1.05	LCF4 - Jury	GENERAL FUND

**City of Socorro
Cash Receipts Report
September 2020**

Effective Date	Name	Transaction Description	GL Code	GL Title	FUND Code	CITY DEPARTMENT Code	Debit	Credit	GRANT/PROGRAM Short Title	FUND Title
9/4/2020	Planning Dept -City of Socorro	PST CR FOR PZ SEP 2020 RECPT.33765-	01010	Wells Fargo-M&O	001	00007	2,010.16		Non grant item	GENERAL FUND
9/4/2020	Planning Dept -City of Socorro	PST CR FOR PZ SEP 2020 RECPT.33765-	04501	Building Permits	001	00007		2,010.16	Non grant item	GENERAL FUND
9/8/2020	Municipal Court-City of Socorr	PST CR FOR MC SEP2020 145350-	01010	Wells Fargo-M&O	001	00006	575.90		Non grant item	GENERAL FUND
9/8/2020	Municipal Court-City of Socorr	PST CR FOR MC SEP2020 145350-	01010		001	00006	3,176.00			
9/8/2020	Municipal Court-City of Socorr	PST CR FOR MC SEP2020 145350-	02115	State Fees Payable	001	00006		991.70	STATE FEE	GENERAL FUND
9/8/2020	Municipal Court-City of Socorr	PST CR FOR MC SEP2020 145350-	04507	Muni. Court Judgements/Fines	001	00006		365.79	CITY FEE	GENERAL FUND
9/8/2020	Municipal Court-City of Socorr	PST CR FOR MC SEP2020 145350-	02613	OMNI Collections	001	00006		18.00	Omnibase Fee	GENERAL FUND
9/8/2020	Municipal Court-City of Socorr	PST CR FOR MC SEP2020 145350-	04507	Muni. Court Judgements/Fines	001	00006		13.93	Court Bldg. Sec	GENERAL FUND
9/8/2020	Municipal Court-City of Socorr	PST CR FOR MC SEP2020 145350-	02617	Collection Agency COLL	001	00006		322.92	Collection Agen	GENERAL FUND
9/8/2020	Municipal Court-City of Socorr	PST CR FOR MC SEP2020 145350-	04507	Muni. Court Judgements/Fines	001	00006		58.48	ChildSftySeat/B	GENERAL FUND
9/8/2020	Municipal Court-City of Socorr	PST CR FOR MC SEP2020 145350-	04507		001	00006		1,807.95	CITY FINE	GENERAL FUND
9/8/2020	Municipal Court-City of Socorr	PST CR FOR MC SEP2020 145350-	04511	Juvenile Case Management Fee	001	00006		23.21	JUV CASE MGMT F	GENERAL FUND
9/8/2020	Municipal Court-City of Socorr	PST CR FOR MC SEP2020 145350-	04511		001	00006		3.00	TRUANCY PREVENT	GENERAL FUND
9/8/2020	Municipal Court-City of Socorr	PST CR FOR MC SEP2020 145350-	04512	Municipal Court Technology	001	00006		18.57	Court Tech Fund	GENERAL FUND
9/8/2020	Municipal Court-City of Socorr	PST CR FOR MC SEP2020 145350-	04507	Muni. Court Judgements/Fines	001	00006		44.92	LCF1 Security	GENERAL FUND
9/8/2020	Municipal Court-City of Socorr	PST CR FOR MC SEP2020 145350-	04507		001	00006		45.85	LCF2 Truancy	GENERAL FUND
9/8/2020	Municipal Court-City of Socorr	PST CR FOR MC SEP2020 145350-	04507		001	00006		36.68	LCF3 - Tech	GENERAL FUND

**City of Socorro
Cash Receipts Report
September 2020**

Effective Date	Name	Transaction Description	GL Code	GL Title	FUND Code	CITY DEPARTMENT Code	Debit	Credit	GRANT/PROGRAM Short Title	FUND Title
9/8/2020	Municipal Court-City of Socorr	PST CR FOR MC SEP2020 145350-	04507		001	00006		0.90	LCF4 - Jury	GENERAL FUND
9/8/2020	Planning Dept -City of Socorro	PST CR FOR PZ SEP 2020 RECPT.33772-	01010	Wells Fargo-M&O	001	00007	1,221.64		Non grant item	GENERAL FUND
9/8/2020	Planning Dept -City of Socorro	PST CR FOR PZ SEP 2020 RECPT.33772-	04501	Building Permits	001	00007		1,221.64	Non grant item	GENERAL FUND
9/9/2020	Municipal Court-City of Socorr	PST CR FOR MC SEP2020 145400-	01010	Wells Fargo-M&O	001	00006	65.00		Non grant item	GENERAL FUND
9/9/2020	Municipal Court-City of Socorr	PST CR FOR MC SEP2020 145400-	01010		001	00006	1,349.00			
9/9/2020	Municipal Court-City of Socorr	PST CR FOR MC SEP2020 145400-	02115	State Fees Payable	001	00006		380.50	STATE FEE	GENERAL FUND
9/9/2020	Municipal Court-City of Socorr	PST CR FOR MC SEP2020 145400-	04507	Muni. Court Judgements/Fines	001	00006		282.60	CITY FEE	GENERAL FUND
9/9/2020	Municipal Court-City of Socorr	PST CR FOR MC SEP2020 145400-	04507		001	00006		3.00	Court Bldg. Sec	GENERAL FUND
9/9/2020	Municipal Court-City of Socorr	PST CR FOR MC SEP2020 145400-	02617	Collection Agency COLL	001	00006		24.95	Collection Agen	GENERAL FUND
9/9/2020	Municipal Court-City of Socorr	PST CR FOR MC SEP2020 145400-	04507	Muni. Court Judgements/Fines	001	00006		660.44	CITY FINE	GENERAL FUND
9/9/2020	Municipal Court-City of Socorr	PST CR FOR MC SEP2020 145400-	04511	Juvenile Case Management Fee	001	00006		5.00	JUV CASE MGMT F	GENERAL FUND
9/9/2020	Municipal Court-City of Socorr	PST CR FOR MC SEP2020 145400-	04511		001	00006		1.00	TRUANCY PREVENT	GENERAL FUND
9/9/2020	Municipal Court-City of Socorr	PST CR FOR MC SEP2020 145400-	04512	Municipal Court Technology	001	00006		4.00	Court Tech Fund	GENERAL FUND
9/9/2020	Municipal Court-City of Socorr	PST CR FOR MC SEP2020 145400-	04507	Muni. Court Judgements/Fines	001	00006		18.35	LCF1 Security	GENERAL FUND
9/9/2020	Municipal Court-City of Socorr	PST CR FOR MC SEP2020 145400-	04507		001	00006		18.74	LCF2 Truancy	GENERAL FUND
9/9/2020	Municipal Court-City of Socorr	PST CR FOR MC SEP2020 145400-	04507		001	00006		14.99	LCF3 - Tech	GENERAL FUND
9/9/2020	Municipal Court-City of Socorr	PST CR FOR MC SEP2020 145400-	04507		001	00006		0.43	LCF4 - Jury	GENERAL FUND

**City of Socorro
Cash Receipts Report
September 2020**

Effective Date	Name	Transaction Description	GL Code	GL Title	FUND Code	CITY DEPARTMENT Code	Debit	Credit	GRANT/PROGRAM Short Title	FUND Title
9/9/2020	Planning Dept -City of Socorro	PST CR FOR PZ SEP 2020 RECPT.33791-	01010	Wells Fargo-M&O	001	00007	1,484.96		Non grant item	GENERAL FUND
9/9/2020	Planning Dept -City of Socorro	PST CR FOR PZ SEP 2020 RECPT.33791-	01010		001	00007	2,742.34			
9/9/2020	Planning Dept -City of Socorro	PST CR FOR PZ SEP 2020 RECPT.33791-	04501	Building Permits	001	00007		3,782.30	Non grant item	GENERAL FUND
9/9/2020	Planning Dept -City of Socorro	PST CR FOR PZ SEP 2020 RECPT.33791-	04502	Business Registration	001	00007		445.00	Non grant item	GENERAL FUND
9/10/2020	Municipal Court-City of Socorr	PST CR FOR MC SEP2020 145413-	01010	Wells Fargo-M&O	001	00006	27.00		Non grant item	GENERAL FUND
9/10/2020	Municipal Court-City of Socorr	PST CR FOR MC SEP2020 145413-	01010		001	00006	2,788.40			
9/10/2020	Municipal Court-City of Socorr	PST CR FOR MC SEP2020 145413-	02115	State Fees Payable	001	00006		1,136.30	STATE FEE	GENERAL FUND
9/10/2020	Municipal Court-City of Socorr	PST CR FOR MC SEP2020 145413-	04507	Muni. Court Judgements/Fines	001	00006		601.80	CITY FEE	GENERAL FUND
9/10/2020	Municipal Court-City of Socorr	PST CR FOR MC SEP2020 145413-	02613	OMNI Collections	001	00006		24.00	Omnibase Fee	GENERAL FUND
9/10/2020	Municipal Court-City of Socorr	PST CR FOR MC SEP2020 145413-	04507	Muni. Court Judgements/Fines	001	00006		9.00	Court Bldg. Sec	GENERAL FUND
9/10/2020	Municipal Court-City of Socorr	PST CR FOR MC SEP2020 145413-	02617	Collection Agency COLL	001	00006		109.44	Collection Agen	GENERAL FUND
9/10/2020	Municipal Court-City of Socorr	PST CR FOR MC SEP2020 145413-	04507	Muni. Court Judgements/Fines	001	00006		791.28	CITY FINE	GENERAL FUND
9/10/2020	Municipal Court-City of Socorr	PST CR FOR MC SEP2020 145413-	04511	Juvenile Case Management Fee	001	00006		15.00	JUV CASE MGMT F	GENERAL FUND
9/10/2020	Municipal Court-City of Socorr	PST CR FOR MC SEP2020 145413-	04511		001	00006		3.00	TRUANCY PREVENT	GENERAL FUND
9/10/2020	Municipal Court-City of Socorr	PST CR FOR MC SEP2020 145413-	04512	Municipal Court Technology	001	00006		12.00	Court Tech Fund	GENERAL FUND
9/10/2020	Municipal Court-City of Socorr	PST CR FOR MC SEP2020 145413-	04507	Muni. Court Judgements/Fines	001	00006		39.75	LCF1 Security	GENERAL FUND
9/10/2020	Municipal Court-City of Socorr	PST CR FOR MC SEP2020 145413-	04507		001	00006		40.57	LCF2 Truancy	GENERAL FUND

**City of Socorro
Cash Receipts Report
September 2020**

Effective Date	Name	Transaction Description	GL Code	GL Title	FUND Code	CITY DEPARTMENT Code	Debit	Credit	GRANT/PROGRAM Short Title	FUND Title
9/10/2020	Municipal Court-City of Socorr	PST CR FOR MC SEP2020 145413-	04507		001	00006		32.45	LCF3 - Tech	GENERAL FUND
9/10/2020	Municipal Court-City of Socorr	PST CR FOR MC SEP2020 145413-	04507		001	00006		0.81	LCF4 - Jury	GENERAL FUND
9/10/2020	Planning Dept -City of Socorro	PST CR FOR PZ SEP 2020 RECPT.33807-	01010	Wells Fargo-M&O	001	00007	1,244.00		Non grant item	GENERAL FUND
9/10/2020	Planning Dept -City of Socorro	PST CR FOR PZ SEP 2020 RECPT.33807-	01010		001	00007	330.00			
9/10/2020	Planning Dept -City of Socorro	PST CR FOR PZ SEP 2020 RECPT.33807-	04501	Building Permits	001	00007		770.00	Non grant item	GENERAL FUND
9/10/2020	Planning Dept -City of Socorro	PST CR FOR PZ SEP 2020 RECPT.33807-	04502	Business Registration	001	00007		704.00	Non grant item	GENERAL FUND
9/10/2020	Planning Dept -City of Socorro	PST CR FOR PZ SEP 2020 RECPT.33807-	04503	Rezoning Fees	001	00007		100.00	Non grant item	GENERAL FUND
9/11/2020	Municipal Court-City of Socorr	PST CR FOR MC SEP2020 145441-	01010	Wells Fargo-M&O	001	00006	452.00		Non grant item	GENERAL FUND
9/11/2020	Municipal Court-City of Socorr	PST CR FOR MC SEP2020 145441-	01010		001	00006	2,792.05			
9/11/2020	Municipal Court-City of Socorr	PST CR FOR MC SEP2020 145441-	02115	State Fees Payable	001	00006		1,366.05	STATE FEE	GENERAL FUND
9/11/2020	Municipal Court-City of Socorr	PST CR FOR MC SEP2020 145441-	04507	Muni. Court Judgements/Fines	001	00006		351.93	CITY FEE	GENERAL FUND
9/11/2020	Municipal Court-City of Socorr	PST CR FOR MC SEP2020 145441-	02613	OMNI Collections	001	00006		17.02	Omnibase Fee	GENERAL FUND
9/11/2020	Municipal Court-City of Socorr	PST CR FOR MC SEP2020 145441-	04507	Muni. Court Judgements/Fines	001	00006		9.91	Court Bldg. Sec	GENERAL FUND
9/11/2020	Municipal Court-City of Socorr	PST CR FOR MC SEP2020 145441-	02617	Collection Agency COLL	001	00006		113.82	Collection Agen	GENERAL FUND
9/11/2020	Municipal Court-City of Socorr	PST CR FOR MC SEP2020 145441-	04507	Muni. Court Judgements/Fines	001	00006		1,227.03	CITY FINE	GENERAL FUND
9/11/2020	Municipal Court-City of Socorr	PST CR FOR MC SEP2020 145441-	04511	Juvenile Case Management Fee	001	00006		16.50	JUV CASE MGMT F	GENERAL FUND
9/11/2020	Municipal Court-City of Socorr	PST CR FOR MC SEP2020 145441-	04511		001	00006		5.84	TRUANCY PREVENT	GENERAL FUND

**City of Socorro
Cash Receipts Report
September 2020**

Effective Date	Name	Transaction Description	GL Code	GL Title	FUND Code	CITY DEPARTMENT Code	Debit	Credit	GRANT/PROGRAM Short Title	FUND Title
9/11/2020	Municipal Court-City of Socorr	PST CR FOR MC SEP2020 145441-	04512	Municipal Court Technology	001	00006		13.20	Court Tech Fund	GENERAL FUND
9/11/2020	Municipal Court-City of Socorr	PST CR FOR MC SEP2020 145441-	04507	Muni. Court Judgements/Fines	001	00006		42.96	LCF1 Security	GENERAL FUND
9/11/2020	Municipal Court-City of Socorr	PST CR FOR MC SEP2020 145441-	04507		001	00006		43.84	LCF2 Truancy	GENERAL FUND
9/11/2020	Municipal Court-City of Socorr	PST CR FOR MC SEP2020 145441-	04507		001	00006		35.08	LCF3 - Tech	GENERAL FUND
9/11/2020	Municipal Court-City of Socorr	PST CR FOR MC SEP2020 145441-	04507		001	00006		0.87	LCF4 - Jury	GENERAL FUND
9/11/2020	Planning Dept -City of Socorro	PST CR FOR PZ SEP 2020 RECPT.33821-	01010	Wells Fargo-M&O	001	00007	955.00		Non grant item	GENERAL FUND
9/11/2020	Planning Dept -City of Socorro	PST CR FOR PZ SEP 2020 RECPT.33821-	01010		001	00007	1,114.00			
9/11/2020	Planning Dept -City of Socorro	PST CR FOR PZ SEP 2020 RECPT.33821-	04501	Building Permits	001	00007		1,454.00	Non grant item	GENERAL FUND
9/11/2020	Planning Dept -City of Socorro	PST CR FOR PZ SEP 2020 RECPT.33821-	04502	Business Registration	001	00007		515.00	Non grant item	GENERAL FUND
9/11/2020	Planning Dept -City of Socorro	PST CR FOR PZ SEP 2020 RECPT.33821-	04500	Other Planning Fees(Fireworks)	001	00007		100.00	Non grant item	GENERAL FUND
9/14/2020	Police Dept-City of Socorro	PST CR FOR PD SEP2020 226540-	01010	Wells Fargo-M&O	001		217.50			GENERAL FUND
9/14/2020	Police Dept-City of Socorro	PST CR FOR PD SEP2020 226540-	04604	Police Fees	001	00005		217.50	Non grant item	GENERAL FUND
9/14/2020	Municipal Court-City of Socorr	PST CR FOR MC SEP2020 145472-	01010	Wells Fargo-M&O	001	00006	1,067.00		Non grant item	GENERAL FUND
9/14/2020	Municipal Court-City of Socorr	PST CR FOR MC SEP2020 145472-	01010		001	00006	4,542.60			
9/14/2020	Municipal Court-City of Socorr	PST CR FOR MC SEP2020 145472-	02115	State Fees Payable	001	00006		1,931.30	STATE FEE	GENERAL FUND
9/14/2020	Municipal Court-City of Socorr	PST CR FOR MC SEP2020 145472-	04507	Muni. Court Judgements/Fines	001	00006		517.80	CITY FEE	GENERAL FUND
9/14/2020	Municipal Court-City of Socorr	PST CR FOR MC SEP2020 145472-	02613	OMNI Collections	001	00006		36.00	Omnibase Fee	GENERAL FUND

**City of Socorro
Cash Receipts Report
September 2020**

Effective Date	Name	Transaction Description	GL Code	GL Title	FUND Code	CITY DEPARTMENT Code	Debit	Credit	GRANT/PROGRAM Short Title	FUND Title
9/14/2020	Municipal Court-City of Socorr	PST CR FOR MC SEP2020 145472-	04507	Muni. Court Judgements/Fines	001	00006		9.00	Court Bldg. Sec	GENERAL FUND
9/14/2020	Municipal Court-City of Socorr	PST CR FOR MC SEP2020 145472-	02617	Collection Agency COLL	001	00006		450.60	Collection Agen	GENERAL FUND
9/14/2020	Municipal Court-City of Socorr	PST CR FOR MC SEP2020 145472-	04507	Muni. Court Judgements/Fines	001	00006		2,397.64	CITY FINE	GENERAL FUND
9/14/2020	Municipal Court-City of Socorr	PST CR FOR MC SEP2020 145472-	04511	Juvenile Case Management Fee	001	00006		15.00	JUV CASE MGMT F	GENERAL FUND
9/14/2020	Municipal Court-City of Socorr	PST CR FOR MC SEP2020 145472-	04511		001	00006		5.00	TRUANCY PREVENT	GENERAL FUND
9/14/2020	Municipal Court-City of Socorr	PST CR FOR MC SEP2020 145472-	04512	Municipal Court Technology	001	00006		12.00	Court Tech Fund	GENERAL FUND
9/14/2020	Municipal Court-City of Socorr	PST CR FOR MC SEP2020 145472-	04507	Muni. Court Judgements/Fines	001	00006		82.34	LCF1 Security	GENERAL FUND
9/14/2020	Municipal Court-City of Socorr	PST CR FOR MC SEP2020 145472-	04507		001	00006		84.01	LCF2 Truancy	GENERAL FUND
9/14/2020	Municipal Court-City of Socorr	PST CR FOR MC SEP2020 145472-	04507		001	00006		67.21	LCF3 - Tech	GENERAL FUND
9/14/2020	Municipal Court-City of Socorr	PST CR FOR MC SEP2020 145472-	04507		001	00006		1.70	LCF4 - Jury	GENERAL FUND
9/14/2020	Planning Dept -City of Socorro	PST CR FOR PZ SEP 2020 RECPT.33839-	01010	Wells Fargo-M&O	001	00007	2,511.12		Non grant item	GENERAL FUND
9/14/2020	Planning Dept -City of Socorro	PST CR FOR PZ SEP 2020 RECPT.33839-	01010		001	00007	1,347.68			
9/14/2020	Planning Dept -City of Socorro	PST CR FOR PZ SEP 2020 RECPT.33839-	04501	Building Permits	001	00007		3,493.40	Non grant item	GENERAL FUND
9/14/2020	Planning Dept -City of Socorro	PST CR FOR PZ SEP 2020 RECPT.33839-	04502	Business Registration	001	00007		365.40	Non grant item	GENERAL FUND
9/15/2020	Municipal Court-City of Socorr	PST CR FOR MC SEP2020 145508-	01010	Wells Fargo-M&O	001	00006	5,187.45		Non grant item	GENERAL FUND
9/15/2020	Municipal Court-City of Socorr	PST CR FOR MC SEP2020 145508-	02115	State Fees Payable	001	00006		1,199.70	STATE FEE	GENERAL FUND
9/15/2020	Municipal Court-City of Socorr	PST CR FOR MC SEP2020 145508-	04507	Muni. Court Judgements/Fines	001	00006		667.41	CITY FEE	GENERAL FUND

**City of Socorro
Cash Receipts Report
September 2020**

Effective Date	Name	Transaction Description	GL Code	GL Title	FUND Code	CITY DEPARTMENT Code	Debit	Credit	GRANT/PROGRAM Short Title	FUND Title
9/15/2020	Municipal Court-City of Socorr	PST CR FOR MC SEP2020 145508-	02613	OMNI Collections	001	00006		96.00	Omnibase Fee	GENERAL FUND
9/15/2020	Municipal Court-City of Socorr	PST CR FOR MC SEP2020 145508-	04507	Muni. Court Judgements/Fines	001	00006		14.20	Court Bldg. Sec	GENERAL FUND
9/15/2020	Municipal Court-City of Socorr	PST CR FOR MC SEP2020 145508-	02617	Collection Agency COLL	001	00006		726.60	Collection Agen	GENERAL FUND
9/15/2020	Municipal Court-City of Socorr	PST CR FOR MC SEP2020 145508-	04507	Muni. Court Judgements/Fines	001	00006		2,321.90	CITY FINE	GENERAL FUND
9/15/2020	Municipal Court-City of Socorr	PST CR FOR MC SEP2020 145508-	04511	Juvenile Case Management Fee	001	00006		23.69	JUV CASE MGMT F	GENERAL FUND
9/15/2020	Municipal Court-City of Socorr	PST CR FOR MC SEP2020 145508-	04511		001	00006		7.00	TRUANCY PREVENT	GENERAL FUND
9/15/2020	Municipal Court-City of Socorr	PST CR FOR MC SEP2020 145508-	04512	Municipal Court Technology	001	00006		18.95	Court Tech Fund	GENERAL FUND
9/15/2020	Municipal Court-City of Socorr	PST CR FOR MC SEP2020 145508-	04507	Muni. Court Judgements/Fines	001	00006		39.20	LCF1 Security	GENERAL FUND
9/15/2020	Municipal Court-City of Socorr	PST CR FOR MC SEP2020 145508-	04507		001	00006		40.00	LCF2 Truancy	GENERAL FUND
9/15/2020	Municipal Court-City of Socorr	PST CR FOR MC SEP2020 145508-	04507		001	00006		32.00	LCF3 - Tech	GENERAL FUND
9/15/2020	Municipal Court-City of Socorr	PST CR FOR MC SEP2020 145508-	04507		001	00006		0.80	LCF4 - Jury	GENERAL FUND
9/15/2020	Planning Dept -City of Socorro	PST CR FOR PZ SEP 2020 RECPT.33856-	01010	Wells Fargo-M&O	001	00007	2,278.24		Non grant item	GENERAL FUND
9/15/2020	Planning Dept -City of Socorro	PST CR FOR PZ SEP 2020 RECPT.33856-	01010		001	00007	4,974.04			
9/15/2020	Planning Dept -City of Socorro	PST CR FOR PZ SEP 2020 RECPT.33856-	04501	Building Permits	001	00007		6,992.28	Non grant item	GENERAL FUND
9/15/2020	Planning Dept -City of Socorro	PST CR FOR PZ SEP 2020 RECPT.33856-	04502	Business Registration	001	00007		160.00	Non grant item	GENERAL FUND
9/15/2020	Planning Dept -City of Socorro	PST CR FOR PZ SEP 2020 RECPT.33856-	04500	Other Planning Fees(Fireworks)	001	00007		100.00	Non grant item	GENERAL FUND
9/16/2020	Municipal Court-City of Socorr	PST CR FOR MC SEP2020 145535-	01010	Wells Fargo-M&O	001	00006	278.00		Non grant item	GENERAL FUND

**City of Socorro
Cash Receipts Report
September 2020**

Effective Date	Name	Transaction Description	GL Code	GL Title	FUND Code	CITY DEPARTMENT Code	Debit	Credit	GRANT/PROGRAM Short Title	FUND Title
9/16/2020	Municipal Court-City of Socorr	PST CR FOR MC SEP2020 145535-	01010		001	00006	2,571.70			
9/16/2020	Municipal Court-City of Socorr	PST CR FOR MC SEP2020 145535-	02115	State Fees Payable	001	00006		869.90	STATE FEE	GENERAL FUND
9/16/2020	Municipal Court-City of Socorr	PST CR FOR MC SEP2020 145535-	04507	Muni. Court Judgements/Fines	001	00006		624.20	CITY FEE	GENERAL FUND
9/16/2020	Municipal Court-City of Socorr	PST CR FOR MC SEP2020 145535-	02613	OMNI Collections	001	00006		18.00	Omnibase Fee	GENERAL FUND
9/16/2020	Municipal Court-City of Socorr	PST CR FOR MC SEP2020 145535-	04507	Muni. Court Judgements/Fines	001	00006		6.00	Court Bldg. Sec	GENERAL FUND
9/16/2020	Municipal Court-City of Socorr	PST CR FOR MC SEP2020 145535-	02617	Collection Agency COLL	001	00006		269.70	Collection Agen	GENERAL FUND
9/16/2020	Municipal Court-City of Socorr	PST CR FOR MC SEP2020 145535-	04507	Muni. Court Judgements/Fines	001	00006		944.38	CITY FINE	GENERAL FUND
9/16/2020	Municipal Court-City of Socorr	PST CR FOR MC SEP2020 145535-	04511	Juvenile Case Management Fee	001	00006		10.00	JUV CASE MGMT F	GENERAL FUND
9/16/2020	Municipal Court-City of Socorr	PST CR FOR MC SEP2020 145535-	04511		001	00006		3.00	TRUANCY PREVENT	GENERAL FUND
9/16/2020	Municipal Court-City of Socorr	PST CR FOR MC SEP2020 145535-	04512	Municipal Court Technology	001	00006		8.00	Court Tech Fund	GENERAL FUND
9/16/2020	Municipal Court-City of Socorr	PST CR FOR MC SEP2020 145535-	04507	Muni. Court Judgements/Fines	001	00006		33.79	LCF1 Security	GENERAL FUND
9/16/2020	Municipal Court-City of Socorr	PST CR FOR MC SEP2020 145535-	04507		001	00006		34.47	LCF2 Truancy	GENERAL FUND
9/16/2020	Municipal Court-City of Socorr	PST CR FOR MC SEP2020 145535-	04507		001	00006		27.57	LCF3 - Tech	GENERAL FUND
9/16/2020	Municipal Court-City of Socorr	PST CR FOR MC SEP2020 145535-	04507		001	00006		0.69	LCF4 - Jury	GENERAL FUND
9/16/2020	Planning Dept -City of Socorro	PST CR FOR PZ SEP 2020 RECPT.33865-	01010	Wells Fargo-M&O	001	00007	1,101.48		Non grant item	GENERAL FUND
9/16/2020	Planning Dept -City of Socorro	PST CR FOR PZ SEP 2020 RECPT.33865-	01010		001	00007	4,474.32			
9/16/2020	Planning Dept -City of Socorro	PST CR FOR PZ SEP 2020 RECPT.33865-	04501	Building Permits	001	00007		5,004.32	Non grant item	GENERAL FUND

**City of Socorro
Cash Receipts Report
September 2020**

Effective Date	Name	Transaction Description	GL Code	GL Title	FUND Code	CITY DEPARTMENT Code	Debit	Credit	GRANT/PROGRAM Short Title	FUND Title
9/16/2020	Planning Dept -City of Socorro	PST CR FOR PZ SEP 2020 RECPT.33865-	04502	Business Registration	001	00007		571.48	Non grant item	GENERAL FUND
9/17/2020	Municipal Court-City of Socorr	PST CR FOR MC SEP2020 145552-	01010	Wells Fargo-M&O	001	00006	789.20		Non grant item	GENERAL FUND
9/17/2020	Municipal Court-City of Socorr	PST CR FOR MC SEP2020 145552-	01010		001	00006	2,649.35			
9/17/2020	Municipal Court-City of Socorr	PST CR FOR MC SEP2020 145552-	02115	State Fees Payable	001	00006		929.90	STATE FEE	GENERAL FUND
9/17/2020	Municipal Court-City of Socorr	PST CR FOR MC SEP2020 145552-	04507	Muni. Court Judgements/Fines	001	00006		743.20	CITY FEE	GENERAL FUND
9/17/2020	Municipal Court-City of Socorr	PST CR FOR MC SEP2020 145552-	02613	OMNI Collections	001	00006		48.00	Omnibase Fee	GENERAL FUND
9/17/2020	Municipal Court-City of Socorr	PST CR FOR MC SEP2020 145552-	04507	Muni. Court Judgements/Fines	001	00006		6.00	Court Bldg. Sec	GENERAL FUND
9/17/2020	Municipal Court-City of Socorr	PST CR FOR MC SEP2020 145552-	02617	Collection Agency COLL	001	00006		332.72	Collection Agen	GENERAL FUND
9/17/2020	Municipal Court-City of Socorr	PST CR FOR MC SEP2020 145552-	04507	Muni. Court Judgements/Fines	001	00006		1,259.73	CITY FINE	GENERAL FUND
9/17/2020	Municipal Court-City of Socorr	PST CR FOR MC SEP2020 145552-	04511	Juvenile Case Management Fee	001	00006		10.00	JUV CASE MGMT F	GENERAL FUND
9/17/2020	Municipal Court-City of Socorr	PST CR FOR MC SEP2020 145552-	04511		001	00006		3.00	TRUANCY PREVENT	GENERAL FUND
9/17/2020	Municipal Court-City of Socorr	PST CR FOR MC SEP2020 145552-	04512	Municipal Court Technology	001	00006		8.00	Court Tech Fund	GENERAL FUND
9/17/2020	Municipal Court-City of Socorr	PST CR FOR MC SEP2020 145552-	04507	Muni. Court Judgements/Fines	001	00006		34.30	LCF1 Security	GENERAL FUND
9/17/2020	Municipal Court-City of Socorr	PST CR FOR MC SEP2020 145552-	04507		001	00006		35.00	LCF2 Truancy	GENERAL FUND
9/17/2020	Municipal Court-City of Socorr	PST CR FOR MC SEP2020 145552-	04507		001	00006		28.00	LCF3 - Tech	GENERAL FUND
9/17/2020	Municipal Court-City of Socorr	PST CR FOR MC SEP2020 145552-	04507		001	00006		0.70	LCF4 - Jury	GENERAL FUND
9/17/2020	Planning Dept -City of Socorro	PST CR FOR PZ SEP 2020 RECPT.33880-	01010	Wells Fargo-M&O	001	00007	1,547.94		Non grant item	GENERAL FUND

**City of Socorro
Cash Receipts Report
September 2020**

Effective Date	Name	Transaction Description	GL Code	GL Title	FUND Code	CITY DEPARTMENT Code	Debit	Credit	GRANT/PROGRAM Short Title	FUND Title
9/17/2020	Planning Dept -City of Socorro	PST CR FOR PZ SEP 2020 RECPT.33880-	01010		001	00007	240.00			
9/17/2020	Planning Dept -City of Socorro	PST CR FOR PZ SEP 2020 RECPT.33880-	04501	Building Permits	001	00007		510.50	Non grant item	GENERAL FUND
9/17/2020	Planning Dept -City of Socorro	PST CR FOR PZ SEP 2020 RECPT.33880-	04502	Business Registration	001	00007		115.00	Non grant item	GENERAL FUND
9/17/2020	Planning Dept -City of Socorro	PST CR FOR PZ SEP 2020 RECPT.33880-	04503	Rezoning Fees	001	00007		1,162.44	Non grant item	GENERAL FUND
9/18/2020	Municipal Court-City of Socorr	PST CR FOR MC SEP2020 145579-	01010	Wells Fargo-M&O	001	00006	1,729.50		Non grant item	GENERAL FUND
9/18/2020	Municipal Court-City of Socorr	PST CR FOR MC SEP2020 145579-	01010		001	00006	3,253.00			
9/18/2020	Municipal Court-City of Socorr	PST CR FOR MC SEP2020 145579-	02115	State Fees Payable	001	00006		1,536.90	STATE FEE	GENERAL FUND
9/18/2020	Municipal Court-City of Socorr	PST CR FOR MC SEP2020 145579-	04507	Muni. Court Judgements/Fines	001	00006		760.40	CITY FEE	GENERAL FUND
9/18/2020	Municipal Court-City of Socorr	PST CR FOR MC SEP2020 145579-	02613	OMNI Collections	001	00006		36.00	Omnibase Fee	GENERAL FUND
9/18/2020	Municipal Court-City of Socorr	PST CR FOR MC SEP2020 145579-	04507	Muni. Court Judgements/Fines	001	00006		12.00	Court Bldg. Sec	GENERAL FUND
9/18/2020	Municipal Court-City of Socorr	PST CR FOR MC SEP2020 145579-	02617	Collection Agency COLL	001	00006		283.50	Collection Agen	GENERAL FUND
9/18/2020	Municipal Court-City of Socorr	PST CR FOR MC SEP2020 145579-	02126	Child Safety Seat/Belt Fines	001	00006		61.95	ChildSftySeat/B	GENERAL FUND
9/18/2020	Municipal Court-City of Socorr	PST CR FOR MC SEP2020 145579-	04507	Muni. Court Judgements/Fines	001	00006		61.95	ChildSftySeat/B	GENERAL FUND
9/18/2020	Municipal Court-City of Socorr	PST CR FOR MC SEP2020 145579-	04507		001	00006		2,043.65	CITY FINE	GENERAL FUND
9/18/2020	Municipal Court-City of Socorr	PST CR FOR MC SEP2020 145579-	04511	Juvenile Case Management Fee	001	00006		20.00	JUV CASE MGMT F	GENERAL FUND
9/18/2020	Municipal Court-City of Socorr	PST CR FOR MC SEP2020 145579-	04511		001	00006		4.00	TRUANCY PREVENT	GENERAL FUND
9/18/2020	Municipal Court-City of Socorr	PST CR FOR MC SEP2020 145579-	04512	Municipal Court Technology	001	00006		16.00	Court Tech Fund	GENERAL FUND

**City of Socorro
Cash Receipts Report
September 2020**

Effective Date	Name	Transaction Description	GL Code	GL Title	FUND Code	CITY DEPARTMENT Code	Debit	Credit	GRANT/PROGRAM Short Title	FUND Title
9/18/2020	Municipal Court-City of Socorr	PST CR FOR MC SEP2020 145579-	04507	Muni. Court Judgements/Fines	001	00006		51.15	LCF1 Security	GENERAL FUND
9/18/2020	Municipal Court-City of Socorr	PST CR FOR MC SEP2020 145579-	04507		001	00006		52.20	LCF2 Truancy	GENERAL FUND
9/18/2020	Municipal Court-City of Socorr	PST CR FOR MC SEP2020 145579-	04507		001	00006		41.76	LCF3 - Tech	GENERAL FUND
9/18/2020	Municipal Court-City of Socorr	PST CR FOR MC SEP2020 145579-	04507		001	00006		1.04	LCF4 - Jury	GENERAL FUND
9/18/2020	Planning Dept -City of Socorro	PST CR FOR PZ SEP 2020 RECPT.33890-	01010	Wells Fargo-M&O	001	00007	768.24		Non grant item	GENERAL FUND
9/18/2020	Planning Dept -City of Socorro	PST CR FOR PZ SEP 2020 RECPT.33890-	01010		001	00007	7,443.02			
9/18/2020	Planning Dept -City of Socorro	PST CR FOR PZ SEP 2020 RECPT.33890-	04501	Building Permits	001	00007		7,838.76	Non grant item	GENERAL FUND
9/18/2020	Planning Dept -City of Socorro	PST CR FOR PZ SEP 2020 RECPT.33890-	04502	Business Registration	001	00007		372.50	Non grant item	GENERAL FUND
9/21/2020	O'Reilly Auto Parts	CHECK NO. 2613057	01010	Wells Fargo-M&O	001		18.69			GENERAL FUND
9/21/2020	O'Reilly Auto Parts	CHECK NO. 2613057	05612	Vehicle Repair & Maintenance	001	00003		18.69	Non grant item	GENERAL FUND
9/21/2020	Prudential Financial Inc.	CHECK NO. 24604734	01010	Wells Fargo-M&O	001		71.50			GENERAL FUND
9/21/2020	Prudential Financial Inc.	CHECK NO. 24604734	04405	Gain/Loss on Investments	001	99999		71.50	Non grant item	GENERAL FUND
9/21/2020	Municipal Court-City of Socorr	PST CR FOR MC SEP2020 145614-	01010	Wells Fargo-M&O	001	00006	620.00		Non grant item	GENERAL FUND
9/21/2020	Municipal Court-City of Socorr	PST CR FOR MC SEP2020 145614-	01010		001	00006	1,810.00			
9/21/2020	Municipal Court-City of Socorr	PST CR FOR MC SEP2020 145614-	02115	State Fees Payable	001	00006		1,062.50	STATE FEE	GENERAL FUND
9/21/2020	Municipal Court-City of Socorr	PST CR FOR MC SEP2020 145614-	04507	Muni. Court Judgements/Fines	001	00006		459.60	CITY FEE	GENERAL FUND
9/21/2020	Municipal Court-City of Socorr	PST CR FOR MC SEP2020 145614-	02613	OMNI Collections	001	00006		12.00	Omnibase Fee	GENERAL FUND

**City of Socorro
Cash Receipts Report
September 2020**

Effective Date	Name	Transaction Description	GL Code	GL Title	FUND Code	CITY DEPARTMENT Code	Debit	Credit	GRANT/PROGRAM Short Title	FUND Title
9/21/2020	Municipal Court-City of Socorr	PST CR FOR MC SEP2020 145614-	04507	Muni. Court Judgements/Fines	001	00006		3.00	Court Bldg. Sec	GENERAL FUND
9/21/2020	Municipal Court-City of Socorr	PST CR FOR MC SEP2020 145614-	04507		001	00006		742.90	CITY FINE	GENERAL FUND
9/21/2020	Municipal Court-City of Socorr	PST CR FOR MC SEP2020 145614-	04511	Juvenile Case Management Fee	001	00006		5.00	JUV CASE MGMT F	GENERAL FUND
9/21/2020	Municipal Court-City of Socorr	PST CR FOR MC SEP2020 145614-	04511		001	00006		1.00	TRUANCY PREVENT	GENERAL FUND
9/21/2020	Municipal Court-City of Socorr	PST CR FOR MC SEP2020 145614-	04512	Municipal Court Technology	001	00006		4.00	Court Tech Fund	GENERAL FUND
9/21/2020	Municipal Court-City of Socorr	PST CR FOR MC SEP2020 145614-	04507	Muni. Court Judgements/Fines	001	00006		49.00	LCF1 Security	GENERAL FUND
9/21/2020	Municipal Court-City of Socorr	PST CR FOR MC SEP2020 145614-	04507		001	00006		50.00	LCF2 Truancy	GENERAL FUND
9/21/2020	Municipal Court-City of Socorr	PST CR FOR MC SEP2020 145614-	04507		001	00006		40.00	LCF3 - Tech	GENERAL FUND
9/21/2020	Municipal Court-City of Socorr	PST CR FOR MC SEP2020 145614-	04507		001	00006		1.00	LCF4 - Jury	GENERAL FUND
9/21/2020	Planning Dept -City of Socorro	PST CR FOR PZ SEP 2020 RECPT.33909-	01010	Wells Fargo-M&O	001	00007	644.16		Non grant item	GENERAL FUND
9/21/2020	Planning Dept -City of Socorro	PST CR FOR PZ SEP 2020 RECPT.33909-	01010		001	00007	167.50			
9/21/2020	Planning Dept -City of Socorro	PST CR FOR PZ SEP 2020 RECPT.33909-	04501	Building Permits	001	00007		509.16	Non grant item	GENERAL FUND
9/21/2020	Planning Dept -City of Socorro	PST CR FOR PZ SEP 2020 RECPT.33909-	04502	Business Registration	001	00007		202.50	Non grant item	GENERAL FUND
9/21/2020	Planning Dept -City of Socorro	PST CR FOR PZ SEP 2020 RECPT.33909-	04500	Other Planning Fees(Fireworks)	001	00007		100.00	Non grant item	GENERAL FUND
9/22/2020	Municipal Court-City of Socorr	PST CR FOR MC SEP2020 145651-	01010	Wells Fargo-M&O	001	00006	826.00		Non grant item	GENERAL FUND
9/22/2020	Municipal Court-City of Socorr	PST CR FOR MC SEP2020 145651-	01010		001	00006	4,178.00			
9/22/2020	Municipal Court-City of Socorr	PST CR FOR MC SEP2020 145651-	02115	State Fees Payable	001	00006		1,591.55	STATE FEE	GENERAL FUND

**City of Socorro
Cash Receipts Report
September 2020**

Effective Date	Name	Transaction Description	GL Code	GL Title	FUND Code	CITY DEPARTMENT Code	Debit	Credit	GRANT/PROGRAM Short Title	FUND Title
9/22/2020	Municipal Court-City of Socorr	PST CR FOR MC SEP2020 145651-	04507	Muni. Court Judgements/Fines	001	00006		582.18	CITY FEE	GENERAL FUND
9/22/2020	Municipal Court-City of Socorr	PST CR FOR MC SEP2020 145651-	02613	OMNI Collections	001	00006		18.00	Omnibase Fee	GENERAL FUND
9/22/2020	Municipal Court-City of Socorr	PST CR FOR MC SEP2020 145651-	04507	Muni. Court Judgements/Fines	001	00006		17.11	Court Bldg. Sec	GENERAL FUND
9/22/2020	Municipal Court-City of Socorr	PST CR FOR MC SEP2020 145651-	02617	Collection Agency COLL	001	00006		354.68	Collection Agen	GENERAL FUND
9/22/2020	Municipal Court-City of Socorr	PST CR FOR MC SEP2020 145651-	04507	Muni. Court Judgements/Fines	001	00006		2,202.31	CITY FINE	GENERAL FUND
9/22/2020	Municipal Court-City of Socorr	PST CR FOR MC SEP2020 145651-	04511	Juvenile Case Management Fee	001	00006		28.51	JUV CASE MGMT F	GENERAL FUND
9/22/2020	Municipal Court-City of Socorr	PST CR FOR MC SEP2020 145651-	04511		001	00006		6.95	TRUANCY PREVENT	GENERAL FUND
9/22/2020	Municipal Court-City of Socorr	PST CR FOR MC SEP2020 145651-	04512	Municipal Court Technology	001	00006		22.80	Court Tech Fund	GENERAL FUND
9/22/2020	Municipal Court-City of Socorr	PST CR FOR MC SEP2020 145651-	04507	Muni. Court Judgements/Fines	001	00006		62.98	LCF1 Security	GENERAL FUND
9/22/2020	Municipal Court-City of Socorr	PST CR FOR MC SEP2020 145651-	04507		001	00006		64.26	LCF2 Truancy	GENERAL FUND
9/22/2020	Municipal Court-City of Socorr	PST CR FOR MC SEP2020 145651-	04507		001	00006		51.40	LCF3 - Tech	GENERAL FUND
9/22/2020	Municipal Court-City of Socorr	PST CR FOR MC SEP2020 145651-	04507		001	00006		1.27	LCF4 - Jury	GENERAL FUND
9/22/2020	Planning Dept -City of Socorro	PST CR FOR PZ SEP 2020 RECPT.33919-	01010	Wells Fargo-M&O	001	00007	5,680.60		Non grant item	GENERAL FUND
9/22/2020	Planning Dept -City of Socorro	PST CR FOR PZ SEP 2020 RECPT.33919-	01010		001	00007	152.65			
9/22/2020	Planning Dept -City of Socorro	PST CR FOR PZ SEP 2020 RECPT.33919-	04501	Building Permits	001	00007		5,683.25	Non grant item	GENERAL FUND
9/22/2020	Planning Dept -City of Socorro	PST CR FOR PZ SEP 2020 RECPT.33919-	04505	Mobile Home Permits	001	00007		150.00	Non grant item	GENERAL FUND
9/23/2020	Municipal Court-City of Socorr	PST CR FOR MC SEP2020 145691-	01010	Wells Fargo-M&O	001	00006	229.10		Non grant item	GENERAL FUND

**City of Socorro
Cash Receipts Report
September 2020**

Effective Date	Name	Transaction Description	GL Code	GL Title	FUND Code	CITY DEPARTMENT Code	Debit	Credit	GRANT/PROGRAM Short Title	FUND Title
9/23/2020	Municipal Court-City of Socorr	PST CR FOR MC SEP2020 145691-	01010		001	00006	2,038.20			
9/23/2020	Municipal Court-City of Socorr	PST CR FOR MC SEP2020 145691-	02115	State Fees Payable	001	00006		879.90	STATE FEE	GENERAL FUND
9/23/2020	Municipal Court-City of Socorr	PST CR FOR MC SEP2020 145691-	04507	Muni. Court Judgements/Fines	001	00006		241.20	CITY FEE	GENERAL FUND
9/23/2020	Municipal Court-City of Socorr	PST CR FOR MC SEP2020 145691-	02613	OMNI Collections	001	00006		18.00	Omnibase Fee	GENERAL FUND
9/23/2020	Municipal Court-City of Socorr	PST CR FOR MC SEP2020 145691-	04507	Muni. Court Judgements/Fines	001	00006		6.00	Court Bldg. Sec	GENERAL FUND
9/23/2020	Municipal Court-City of Socorr	PST CR FOR MC SEP2020 145691-	02617	Collection Agency COLL	001	00006		176.06	Collection Agen	GENERAL FUND
9/23/2020	Municipal Court-City of Socorr	PST CR FOR MC SEP2020 145691-	04507	Muni. Court Judgements/Fines	001	00006		822.97	CITY FINE	GENERAL FUND
9/23/2020	Municipal Court-City of Socorr	PST CR FOR MC SEP2020 145691-	04511	Juvenile Case Management Fee	001	00006		10.00	JUV CASE MGMT F	GENERAL FUND
9/23/2020	Municipal Court-City of Socorr	PST CR FOR MC SEP2020 145691-	04511		001	00006		3.00	TRUANCY PREVENT	GENERAL FUND
9/23/2020	Municipal Court-City of Socorr	PST CR FOR MC SEP2020 145691-	04512	Municipal Court Technology	001	00006		8.00	Court Tech Fund	GENERAL FUND
9/23/2020	Municipal Court-City of Socorr	PST CR FOR MC SEP2020 145691-	04507	Muni. Court Judgements/Fines	001	00006		35.77	LCF1 Security	GENERAL FUND
9/23/2020	Municipal Court-City of Socorr	PST CR FOR MC SEP2020 145691-	04507		001	00006		36.49	LCF2 Truancy	GENERAL FUND
9/23/2020	Municipal Court-City of Socorr	PST CR FOR MC SEP2020 145691-	04507		001	00006		29.19	LCF3 - Tech	GENERAL FUND
9/23/2020	Municipal Court-City of Socorr	PST CR FOR MC SEP2020 145691-	04507		001	00006		0.72	LCF4 - Jury	GENERAL FUND
9/23/2020	Planning Dept -City of Socorro	PST CR FOR PZ SEP 2020 RECPT.33930-	01010	Wells Fargo-M&O	001	00007	640.26		Non grant item	GENERAL FUND
9/23/2020	Planning Dept -City of Socorro	PST CR FOR PZ SEP 2020 RECPT.33930-	04501	Building Permits	001	00007		622.76	Non grant item	GENERAL FUND
9/23/2020	Planning Dept -City of Socorro	PST CR FOR PZ SEP 2020 RECPT.33930-	04502	Business Registration	001	00007		17.50	Non grant item	GENERAL FUND

**City of Socorro
Cash Receipts Report
September 2020**

Effective Date	Name	Transaction Description	GL Code	GL Title	FUND Code	CITY DEPARTMENT Code	Debit	Credit	GRANT/PROGRAM Short Title	FUND Title
9/24/2020	Municipal Court-City of Socorr	PST CR FOR MC SEP2020 145711-	01010	Wells Fargo-M&O	001	00006	325.00		Non grant item	GENERAL FUND
9/24/2020	Municipal Court-City of Socorr	PST CR FOR MC SEP2020 145711-	01010		001	00006	2,659.20			
9/24/2020	Municipal Court-City of Socorr	PST CR FOR MC SEP2020 145711-	02115	State Fees Payable	001	00006		1,273.50	STATE FEE	GENERAL FUND
9/24/2020	Municipal Court-City of Socorr	PST CR FOR MC SEP2020 145711-	04507	Muni. Court Judgements/Fines	001	00006		574.80	CITY FEE	GENERAL FUND
9/24/2020	Municipal Court-City of Socorr	PST CR FOR MC SEP2020 145711-	02613	OMNI Collections	001	00006		24.00	Omnibase Fee	GENERAL FUND
9/24/2020	Municipal Court-City of Socorr	PST CR FOR MC SEP2020 145711-	04507	Muni. Court Judgements/Fines	001	00006		9.00	Court Bldg. Sec	GENERAL FUND
9/24/2020	Municipal Court-City of Socorr	PST CR FOR MC SEP2020 145711-	02617	Collection Agency COLL	001	00006		107.40	Collection Agen	GENERAL FUND
9/24/2020	Municipal Court-City of Socorr	PST CR FOR MC SEP2020 145711-	04507	Muni. Court Judgements/Fines	001	00006		839.50	CITY FINE	GENERAL FUND
9/24/2020	Municipal Court-City of Socorr	PST CR FOR MC SEP2020 145711-	04511	Juvenile Case Management Fee	001	00006		15.00	JUV CASE MGMT F	GENERAL FUND
9/24/2020	Municipal Court-City of Socorr	PST CR FOR MC SEP2020 145711-	04511		001	00006		3.00	TRUANCY PREVENT	GENERAL FUND
9/24/2020	Municipal Court-City of Socorr	PST CR FOR MC SEP2020 145711-	04512	Municipal Court Technology	001	00006		12.00	Court Tech Fund	GENERAL FUND
9/24/2020	Municipal Court-City of Socorr	PST CR FOR MC SEP2020 145711-	04507	Muni. Court Judgements/Fines	001	00006		44.10	LCF1 Security	GENERAL FUND
9/24/2020	Municipal Court-City of Socorr	PST CR FOR MC SEP2020 145711-	04507		001	00006		45.00	LCF2 Truancy	GENERAL FUND
9/24/2020	Municipal Court-City of Socorr	PST CR FOR MC SEP2020 145711-	04507		001	00006		36.00	LCF3 - Tech	GENERAL FUND
9/24/2020	Municipal Court-City of Socorr	PST CR FOR MC SEP2020 145711-	04507		001	00006		0.90	LCF4 - Jury	GENERAL FUND
9/24/2020	Planning Dept -City of Socorro	PST CR FOR PZ SEP 2020 RECPT.33937-	01010	Wells Fargo-M&O	001	00007	4,796.84		Non grant item	GENERAL FUND
9/24/2020	Planning Dept -City of Socorro	PST CR FOR PZ SEP 2020 RECPT.33937-	01010		001	00007	650.00			

**City of Socorro
Cash Receipts Report
September 2020**

Effective Date	Name	Transaction Description	GL Code	GL Title	FUND Code	CITY DEPARTMENT Code	Debit	Credit	GRANT/PROGRAM Short Title	FUND Title
9/24/2020	Planning Dept -City of Socorro	PST CR FOR PZ SEP 2020 RECPT.33937-	04501	Building Permits	001	00007		5,296.84	Non grant item	GENERAL FUND
9/24/2020	Planning Dept -City of Socorro	PST CR FOR PZ SEP 2020 RECPT.33937-	04502	Business Registration	001	00007		150.00	Non grant item	GENERAL FUND
9/25/2020	Municipal Court-City of Socorr	PST CR FOR MC SEP2020 145752-	01010	Wells Fargo-M&O	001	00006	1,506.80		Non grant item	GENERAL FUND
9/25/2020	Municipal Court-City of Socorr	PST CR FOR MC SEP2020 145752-	01010		001	00006	2,187.30			
9/25/2020	Municipal Court-City of Socorr	PST CR FOR MC SEP2020 145752-	02115	State Fees Payable	001	00006		1,175.96	STATE FEE	GENERAL FUND
9/25/2020	Municipal Court-City of Socorr	PST CR FOR MC SEP2020 145752-	04507	Muni. Court Judgements/Fines	001	00006		650.05	CITY FEE	GENERAL FUND
9/25/2020	Municipal Court-City of Socorr	PST CR FOR MC SEP2020 145752-	02613	OMNI Collections	001	00006		24.00	Omnibase Fee	GENERAL FUND
9/25/2020	Municipal Court-City of Socorr	PST CR FOR MC SEP2020 145752-	04507	Muni. Court Judgements/Fines	001	00006		18.64	Court Bldg. Sec	GENERAL FUND
9/25/2020	Municipal Court-City of Socorr	PST CR FOR MC SEP2020 145752-	02617	Collection Agency COLL	001	00006		367.00	Collection Agen	GENERAL FUND
9/25/2020	Municipal Court-City of Socorr	PST CR FOR MC SEP2020 145752-	04507	Muni. Court Judgements/Fines	001	00006		1,311.90	CITY FINE	GENERAL FUND
9/25/2020	Municipal Court-City of Socorr	PST CR FOR MC SEP2020 145752-	04511	Juvenile Case Management Fee	001	00006		31.06	JUV CASE MGMT F	GENERAL FUND
9/25/2020	Municipal Court-City of Socorr	PST CR FOR MC SEP2020 145752-	04511		001	00006		6.64	TRUANCY PREVENT	GENERAL FUND
9/25/2020	Municipal Court-City of Socorr	PST CR FOR MC SEP2020 145752-	04512	Municipal Court Technology	001	00006		24.85	Court Tech Fund	GENERAL FUND
9/25/2020	Municipal Court-City of Socorr	PST CR FOR MC SEP2020 145752-	04507	Muni. Court Judgements/Fines	001	00006		29.40	LCF1 Security	GENERAL FUND
9/25/2020	Municipal Court-City of Socorr	PST CR FOR MC SEP2020 145752-	04507		001	00006		30.00	LCF2 Truancy	GENERAL FUND
9/25/2020	Municipal Court-City of Socorr	PST CR FOR MC SEP2020 145752-	04507		001	00006		24.00	LCF3 - Tech	GENERAL FUND
9/25/2020	Municipal Court-City of Socorr	PST CR FOR MC SEP2020 145752-	04507		001	00006		0.60	LCF4 - Jury	GENERAL FUND

**City of Socorro
Cash Receipts Report
September 2020**

Effective Date	Name	Transaction Description	GL Code	GL Title	FUND Code	CITY DEPARTMENT Code	Debit	Credit	GRANT/PROGRAM Short Title	FUND Title
9/25/2020	Planning Dept -City of Socorro	PST CR FOR PZ SEP 2020 RECPT.33946-	01010	Wells Fargo-M&O	001	00007	995.52		Non grant item	GENERAL FUND
9/25/2020	Planning Dept -City of Socorro	PST CR FOR PZ SEP 2020 RECPT.33946-	01010		001	00007	6,536.22			
9/25/2020	Planning Dept -City of Socorro	PST CR FOR PZ SEP 2020 RECPT.33946-	04501	Building Permits	001	00007		7,531.74	Non grant item	GENERAL FUND
9/28/2020	Municipal Court-City of Socorr	PST CR FOR MC SEP2020 145777-	01010	Wells Fargo-M&O	001	00006	1,492.00		Non grant item	GENERAL FUND
9/28/2020	Municipal Court-City of Socorr	PST CR FOR MC SEP2020 145777-	01010		001	00006	5,314.10			
9/28/2020	Municipal Court-City of Socorr	PST CR FOR MC SEP2020 145777-	01010		001	00006	855.00			
9/28/2020	Municipal Court-City of Socorr	PST CR FOR MC SEP2020 145777-	02115	State Fees Payable	001	00006		2,474.93	STATE FEE	GENERAL FUND
9/28/2020	Municipal Court-City of Socorr	PST CR FOR MC SEP2020 145777-	04507	Muni. Court Judgements/Fines	001	00006		1,022.31	CITY FEE	GENERAL FUND
9/28/2020	Municipal Court-City of Socorr	PST CR FOR MC SEP2020 145777-	02613	OMNI Collections	001	00006		54.00	Omnibase Fee	GENERAL FUND
9/28/2020	Municipal Court-City of Socorr	PST CR FOR MC SEP2020 145777-	04507	Muni. Court Judgements/Fines	001	00006		51.37	Court Bldg. Sec	GENERAL FUND
9/28/2020	Municipal Court-City of Socorr	PST CR FOR MC SEP2020 145777-	02617	Collection Agency COLL	001	00006		662.85	Collection Agen	GENERAL FUND
9/28/2020	Municipal Court-City of Socorr	PST CR FOR MC SEP2020 145777-	04507	Muni. Court Judgements/Fines	001	00006		3,040.20	CITY FINE	GENERAL FUND
9/28/2020	Municipal Court-City of Socorr	PST CR FOR MC SEP2020 145777-	04511	Juvenile Case Management Fee	001	00006		85.62	JUV CASE MGMT F	GENERAL FUND
9/28/2020	Municipal Court-City of Socorr	PST CR FOR MC SEP2020 145777-	04511		001	00006		18.47	TRUANCY PREVENT	GENERAL FUND
9/28/2020	Municipal Court-City of Socorr	PST CR FOR MC SEP2020 145777-	04512	Municipal Court Technology	001	00006		68.50	Court Tech Fund	GENERAL FUND
9/28/2020	Municipal Court-City of Socorr	PST CR FOR MC SEP2020 145777-	04507	Muni. Court Judgements/Fines	001	00006		64.00	LCF1 Security	GENERAL FUND
9/28/2020	Municipal Court-City of Socorr	PST CR FOR MC SEP2020 145777-	04507		001	00006		65.30	LCF2 Truancy	GENERAL FUND

**City of Socorro
Cash Receipts Report
September 2020**

Effective Date	Name	Transaction Description	GL Code	GL Title	FUND Code	CITY DEPARTMENT Code	Debit	Credit	GRANT/PROGRAM Short Title	FUND Title
9/28/2020	Municipal Court-City of Socorr	PST CR FOR MC SEP2020 145777-	04507		001	00006		52.24	LCF3 - Tech	GENERAL FUND
9/28/2020	Municipal Court-City of Socorr	PST CR FOR MC SEP2020 145777-	04507		001	00006		1.31	LCF4 - Jury	GENERAL FUND
9/28/2020	Planning Dept -City of Socorro	PST CR FOR PZ SEP 2020 RECPT.33961-	01010	Wells Fargo-M&O	001	00007	1,813.42		Non grant item	GENERAL FUND
9/28/2020	Planning Dept -City of Socorro	PST CR FOR PZ SEP 2020 RECPT.33961-	01010		001	00007	290.00			
9/28/2020	Planning Dept -City of Socorro	PST CR FOR PZ SEP 2020 RECPT.33961-	04501	Building Permits	001	00007		1,631.42	Non grant item	GENERAL FUND
9/28/2020	Planning Dept -City of Socorro	PST CR FOR PZ SEP 2020 RECPT.33961-	04502	Business Registration	001	00007		472.00	Non grant item	GENERAL FUND
9/29/2020	Verizon	LEAS20201001 CK4515131	01010	Wells Fargo-M&O	001		1,000.00			GENERAL FUND
9/29/2020	Verizon	LEAS20201001 CK4515131	04701	Rental Income	001	99999		1,000.00	Non grant item	GENERAL FUND
9/29/2020	Police Dept-City of Socorro	PST CR FOR PD SEP2020 226548-	01010	Wells Fargo-M&O	001		96.00			GENERAL FUND
9/29/2020	Police Dept-City of Socorro	PST CR FOR PD SEP2020 226548-	04604	Police Fees	001	00005		96.00	Non grant item	GENERAL FUND
9/29/2020	Municipal Court-City of Socorr	PST CR FOR MC SEP2020 145819-	01010	Wells Fargo-M&O	001	00006	30.00		Non grant item	GENERAL FUND
9/29/2020	Municipal Court-City of Socorr	PST CR FOR MC SEP2020 145819-	01010		001	00006	2,204.30			
9/29/2020	Municipal Court-City of Socorr	PST CR FOR MC SEP2020 145819-	02115	State Fees Payable	001	00006		553.90	STATE FEE	GENERAL FUND
9/29/2020	Municipal Court-City of Socorr	PST CR FOR MC SEP2020 145819-	04507	Muni. Court Judgements/Fines	001	00006		364.20	CITY FEE	GENERAL FUND
9/29/2020	Municipal Court-City of Socorr	PST CR FOR MC SEP2020 145819-	02613	OMNI Collections	001	00006		48.00	Omnibase Fee	GENERAL FUND
9/29/2020	Municipal Court-City of Socorr	PST CR FOR MC SEP2020 145819-	04507	Muni. Court Judgements/Fines	001	00006		6.00	Court Bldg. Sec	GENERAL FUND
9/29/2020	Municipal Court-City of Socorr	PST CR FOR MC SEP2020 145819-	02617	Collection Agency COLL	001	00006		264.30	Collection Agen	GENERAL FUND

**City of Socorro
Cash Receipts Report
September 2020**

Effective Date	Name	Transaction Description	GL Code	GL Title	FUND Code	CITY DEPARTMENT Code	Debit	Credit	GRANT/PROGRAM Short Title	FUND Title
9/29/2020	Municipal Court-City of Socorr	PST CR FOR MC SEP2020 145819-	04507	Muni. Court Judgements/Fines	001	00006		928.15	CITY FINE	GENERAL FUND
9/29/2020	Municipal Court-City of Socorr	PST CR FOR MC SEP2020 145819-	04511	Juvenile Case Management Fee	001	00006		10.00	JUV CASE MGMT F	GENERAL FUND
9/29/2020	Municipal Court-City of Socorr	PST CR FOR MC SEP2020 145819-	04511		001	00006		3.00	TRUANCY PREVENT	GENERAL FUND
9/29/2020	Municipal Court-City of Socorr	PST CR FOR MC SEP2020 145819-	04512	Municipal Court Technology	001	00006		8.00	Court Tech Fund	GENERAL FUND
9/29/2020	Municipal Court-City of Socorr	PST CR FOR MC SEP2020 145819-	04507	Muni. Court Judgements/Fines	001	00006		17.05	LCF1 Security	GENERAL FUND
9/29/2020	Municipal Court-City of Socorr	PST CR FOR MC SEP2020 145819-	04507		001	00006		17.40	LCF2 Truancy	GENERAL FUND
9/29/2020	Municipal Court-City of Socorr	PST CR FOR MC SEP2020 145819-	04507		001	00006		13.94	LCF3 - Tech	GENERAL FUND
9/29/2020	Municipal Court-City of Socorr	PST CR FOR MC SEP2020 145819-	04507		001	00006		0.36	LCF4 - Jury	GENERAL FUND
9/29/2020	Planning Dept -City of Socorro	PST CR FOR PZ SEP 2020 RECPT.33979-	01010	Wells Fargo-M&O	001	00007	550.00		Non grant item	GENERAL FUND
9/29/2020	Planning Dept -City of Socorro	PST CR FOR PZ SEP 2020 RECPT.33979-	01010		001	00007	252.00			
9/29/2020	Planning Dept -City of Socorro	PST CR FOR PZ SEP 2020 RECPT.33979-	04501	Building Permits	001	00007		722.00	Non grant item	GENERAL FUND
9/29/2020	Planning Dept -City of Socorro	PST CR FOR PZ SEP 2020 RECPT.33979-	04502	Business Registration	001	00007		80.00	Non grant item	GENERAL FUND
9/30/2020	Administration-City of Socorro	ORR, RECEIPTS: 587449-587453	01010	Wells Fargo-M&O	001		3.00			GENERAL FUND
9/30/2020	Administration-City of Socorro	ORR, RECEIPTS: 587449-587453	04504	AdmMisc-Copies,City Clrk	001	00014		3.00	Non grant item	GENERAL FUND
9/30/2020	Administration-City of Socorro	ORR, RECEIPTS: 587454-455,	01010	Wells Fargo-M&O	001		3.40			GENERAL FUND
9/30/2020	Administration-City of Socorro	ORR, RECEIPTS: 587454-455,	04504	AdmMisc-Copies,City Clrk	001	99999		3.40	Non grant item	GENERAL FUND
9/30/2020	Administration-City of Socorro	SALES TAX REIMBURSEMENT -	01010	Wells Fargo-M&O	001		4.64			GENERAL FUND

**City of Socorro
Cash Receipts Report
September 2020**

Effective Date	Name	Transaction Description	GL Code	GL Title	FUND Code	CITY DEPARTMENT Code	Debit	Credit	GRANT/PROGRAM Short Title	FUND Title
9/30/2020	Administration-City of Socorro	SALES TAX REIMBURSEMENT -	01100	Accounts Receivable	001			4.64		GENERAL FUND
9/30/2020	Administration-City of Socorro	SALES TAX REIMBURSEMENT;	01010	Wells Fargo-M&O	001		1.12			GENERAL FUND
9/30/2020	Administration-City of Socorro	SALES TAX REIMBURSEMENT;	01100	Accounts Receivable	001			1.12		GENERAL FUND
9/30/2020	Administration-City of Socorro	SALES TAX REIMBURSEMENT -	01010	Wells Fargo-M&O	001		4.91			GENERAL FUND
9/30/2020	Administration-City of Socorro	SALES TAX REIMBURSEMENT -	01100	Accounts Receivable	001			4.91		GENERAL FUND
9/30/2020	Municipal Court-City of Socorr	PST CR FOR MC SEP2020 145853-	01010	Wells Fargo-M&O	001	00006	707.00		Non grant item	GENERAL FUND
9/30/2020	Municipal Court-City of Socorr	PST CR FOR MC SEP2020 145853-	01010		001	00006	3,272.40			
9/30/2020	Municipal Court-City of Socorr	PST CR FOR MC SEP2020 145853-	02115	State Fees Payable	001	00006		1,323.70	STATE FEE	GENERAL FUND
9/30/2020	Municipal Court-City of Socorr	PST CR FOR MC SEP2020 145853-	04507	Muni. Court Judgements/Fines	001	00006		821.50	CITY FEE	GENERAL FUND
9/30/2020	Municipal Court-City of Socorr	PST CR FOR MC SEP2020 145853-	02613	OMNI Collections	001	00006		54.00	Omnibase Fee	GENERAL FUND
9/30/2020	Municipal Court-City of Socorr	PST CR FOR MC SEP2020 145853-	04507	Muni. Court Judgements/Fines	001	00006		15.00	Court Bldg. Sec	GENERAL FUND
9/30/2020	Municipal Court-City of Socorr	PST CR FOR MC SEP2020 145853-	02617	Collection Agency COLL	001	00006		300.76	Collection Agen	GENERAL FUND
9/30/2020	Municipal Court-City of Socorr	PST CR FOR MC SEP2020 145853-	04507	Muni. Court Judgements/Fines	001	00006		1,280.83	CITY FINE	GENERAL FUND
9/30/2020	Municipal Court-City of Socorr	PST CR FOR MC SEP2020 145853-	04511	Juvenile Case Management Fee	001	00006		25.00	JUV CASE MGMT F	GENERAL FUND
9/30/2020	Municipal Court-City of Socorr	PST CR FOR MC SEP2020 145853-	04511		001	00006		6.00	TRUANCY PREVENT	GENERAL FUND
9/30/2020	Municipal Court-City of Socorr	PST CR FOR MC SEP2020 145853-	04512	Municipal Court Technology	001	00006		20.00	Court Tech Fund	GENERAL FUND
9/30/2020	Municipal Court-City of Socorr	PST CR FOR MC SEP2020 145853-	04507	Muni. Court Judgements/Fines	001	00006		46.41	LCF1 Security	GENERAL FUND

City of Socorro
Cash Receipts Report
September 2020

Effective Date	Name	Transaction Description	GL Code	GL Title	FUND Code	CITY DEPARTMENT Code	Debit	Credit	GRANT/PROGRAM Short Title	FUND Title
9/30/2020	Municipal Court-City of Socorr	PST CR FOR MC SEP2020 145853-	04507		001	00006		47.36	LCF2 Truancy	GENERAL FUND
9/30/2020	Municipal Court-City of Socorr	PST CR FOR MC SEP2020 145853-	04507		001	00006		37.88	LCF3 - Tech	GENERAL FUND
9/30/2020	Municipal Court-City of Socorr	PST CR FOR MC SEP2020 145853-	04507		001	00006		0.96	LCF4 - Jury	GENERAL FUND
9/30/2020	Planning Dept -City of Socorro	PST CR FOR PZ SEP 2020 RECPT.33987-	01010	Wells Fargo-M&O	001	00007	1,051.24		Non grant item	GENERAL FUND
9/30/2020	Planning Dept -City of Socorro	PST CR FOR PZ SEP 2020 RECPT.33987-	01010		001	00007	420.00			
9/30/2020	Planning Dept -City of Socorro	2020 RECPT.33987-33993	04501	Building Permits	001	00007		1,471.24	Non grant item	GENERAL FUND
Report Total							\$147,511.29	\$147,511.29		

ITEM 9

Elia Garcia
Mayor
Rene Rodriguez
At Large
Cesar Nevarez
District 1 / Mayor Pro Tem



Ralph Duran
District 2
Victor Perez
District 3
Yvonne Colon-Villalobos
District 4
Adriana Rodarte
City Manager

DATE: October 29, 2020

TO: MAYOR AND CITY COUNCIL MEMBERS

FROM: Charles Casiano, Finance Director

SUBJECT: Discussion and action on approving September 2020 unaudited financial report.

SUMMARY

This action approves the unaudited financial reports through September 2020.

STATEMENT OF THE ISSUE

Section 3.12 (E) of the City of Socorro's Charter states

The City Council shall, at the end of each month, prepare or have prepared under its direction, a statement as to financial receipts and disbursements for that particular month, and shall have such statement no later than the 25th day of the following month and shall have a copy of said statement available in the office of the City Secretary for examination and a copy will be made, at a reasonable charge, for those who request one.

FINANCIAL IMPACT

None

ALTERNATIVE

None

STAFF RECOMMENDATION

The Staff is recommending the approval of this item.

City of Socorro
 Unaudited Budget Vs Expenditures
 General Fund
 For October 1, 2019 through September 30, 2020

Summary of Revenues vs Expenditures

	Budget	Oct-19	Nov-19	Dec-19	Jan-20	Feb-20	Mar-20	Apr-20	May-20	June-20	July-20	Aug-20	Sept-20	YTD Actual	Budgeted Balance	Per. Of Bud
Total Revenues	10,852,330	455,283	734,289	2,723,970	2,050,243	1,587,994	576,116	267,142	496,914	383,723	562,535	359,328	310,494	10,508,032	(344,297)	97%
Total Expenditures	10,363,987	723,156	723,141	751,872	727,196	873,815	896,191	883,518	760,189	796,811	629,371	744,644	900,293	9,410,197	953,789	91%
Total Excess (Deficit)	488,343	(267,874)	11,148	1,972,098	1,323,047	714,179	(320,076)	(616,376)	(263,274)	(413,088)	(66,836)	(385,316)	(589,799)	1,097,835	609,492	6%

<i>Revenues</i>																
Account Title	Budget	Oct-19	Nov-19	Dec-19	Jan-20	Feb-20	Mar-20	Apr-20	May-20	June-20	July-20	Aug-20	Sept-20	YTD Actual	Budgeted Balance	Per. Of Bud
Property Taxes	6,336,613	68,732	402,782	2,442,823	1,672,532	1,166,721	243,458	80,013	82,295	78,986	50,675	37,966	31,138	6,358,121	21,508	100%
Sales Taxes	1,550,000	112,798	136,392	127,561	115,056	155,782	125,169	117,400	156,445	138,836	152,471	164,507	138,313	1,640,730	90,730	106%
Franchise Taxes	650,000	147,478	28,926	-	87,732	73,091	93	-	102,118	34	164,607	26,221	-	630,299	(19,701)	97%
Hotel Tax		3,341	-	-	-	-	-	-	2,614	-	2,783	-	-	8,738	8,738	#DIV/0!
Property Taxes-Delinquent	170,000	22,360	31,024	22,968	23,310	22,685	31,411	5,736	11,219	19,140	12,875	9,496	14,399	226,621	56,621	133%
Mixed Beverage Tax		2,365	-	-	2,699	-	1,964	-	-	-	1,134	-	-	8,161	8,161	#DIV/0!
Interest Earned	45,000	411	14,726	17,372	17,213	20,628	23,878	14,444	11,491	8,595	5,983	4,203	2,923	141,866	96,866	315%
Other Plan Fees(Fireworks)	5,000	150	-	100	-	400	90	-	100	50	-	300	300	1,490	(3,510)	30%
Building Permits	700,000	52,662	70,926	44,094	67,851	52,621	62,171	22,761	86,458	88,681	129,129	68,425	65,792	811,570	111,570	116%
Business Registrations	70,000	1,166	2,336	520	2,788	2,775	14,899	3,144	3,977	4,304	2,589	2,652	4,858	46,009	(23,991)	66%
Rezoning Fees	50,000	1,784	1,293	-	-	5,895	746	1,550	2,715	1,591	1,940	550	1,262	19,327	(30,673)	39%
AdmMisc-Copies,City Clrk	100	74	17	14	15	10	26	6	1	1	4	13	6	188	88	188%
Mobile Home Permits	3,000	585	60	105	209	105	600	-	-	375	425	300	150	2,914	(86)	97%
Muni. Court Judgements	640,000	38,238	29,756	45,864	48,145	52,584	64,916	17,523	26,394	32,014	36,067	39,684	49,118	480,302	(159,698)	75%
Juvenile Case Mgmt Fee	12,000	1,280	1,360	1,771	1,218	780	761	221	332	457	386	282	507	9,355	(2,645)	78%
Municipal Court Tech		867	898	1,185	960	532	525	155	256	331	273	204	336	6,521	6,521	#DIV/0!
Police Fees	5,000	621	574	673	(101)	1,046	552	30	214	114	420	904	320	5,366	366	107%
Rental Fees	12,000	1	1,001	1,001	1,001	1,001	1,001	1,001	1,001	2,001	1	2,001	1,001	12,012	12	100%
Other Revenue	47,000	-	1,308	5,176	3,242	30,837	3,242	3,242	3,242	3,242	-	1,621	-	55,153	8,153	117%

City of Socorro
 Unaudited Budget Vs Expenditures
 General Fund
 For October 1, 2019 through September 30, 2020

<i>Revenues</i>	Budget	Oct-19	Nov-19	Dec-19	Jan-20	Feb-20	Mar-20			June -20	July -20	Aug -20	Sept -20	YTD Actual	Budgeted	Per. Of Bud
								Apr-20	May -20						Balance	
Reimbursed cost	3,000	-	-	-	-	-	-	-	-	-	-	-	-	-	(3,000)	
Park Fees	500	160	170	-	90	-	(60)	(90)	-	-	-	-	-	270	(230)	54%
Event Sponsorships	0	210	10,290	750	750	-	-	-	-	-	-	-	-	12,000	12,000	
Event Registrations	0	-	450	1,010	-	-	120	-	-	-	-	-	-	1,580	1,580	
Miscellaneous Income	2,200	-	-	10,984	5,533	500	557	8	6,043	4,970	774	-	72	29,440	27,240	1338%
Prior Years Revenue	550,917	-	-	-	-	-	-	-	-	-	-	-	-	-	(550,917)	0%
Total Revenues	10,852,330	455,283	734,289	2,723,970	2,050,243	1,587,994	576,116	267,142	496,914	383,723	562,535	359,328	310,494	10,508,032	(344,297)	97%

City of Socorro
 Unaudited Budget Vs Expenditures
 General Fund
 For October 1, 2019 through September 30, 2020

<i>Expenditures-City Manager</i>															Budgeted	
Account Title	Budget	Oct-19	Nov-19	Dec-19	Jan-20	Feb-20	Mar-20	Apr-20	May -20	June -20	July -20	Aug -20	Sept -20	YTD Actual	Balance	Per. Of Bud
Salaries	417,277	36,803	32,924	35,468	34,844	33,212	35,252	34,915	37,781	34,299	35,577	30,866	39,231	421,172	(3,895)	101%
Overtime	11,500	748	746	1,006	878	816	913	419	779	721	366	770	647	8,811	2,689	77%
FICA/Medicare Taxes	33,580	2,873	2,576	2,748	2,655	2,531	2,689	2,628	2,873	2,605	2,673	2,353	2,963	32,167	1,413	96%
T.W.C. Payroll Taxes	1,478	0	0	20	29	80	929	384	2	0	0	0	0	1,444	34	98%
Premiums	70,080	5,229	5,229	5,229	5,229	4,990	5,229	5,229	5,229	5,229	5,229	4,990	5,229	62,269	7,811	89%
Workers Compensation Ins	15,100	17	17	17	17	17	17	17	17	1,254	11,150	1,254	1,254	15,048	52	100%
Deferred Compensation	13,700	1,168	1,038	1,139	1,262	1,066	1,139	1,197	1,139	1,225	1,139	992	1,250	13,755	(55)	100%
Life Insurance	1,532	128	126	113	113	83	113	113	113	113	113	83	113	1,321	211	86%
Dental Insurance Expense	2,339	249	233	208	208	129	208	208	208	171	186	444	(141)	2,309	30	99%
Vision Insurance Expense	624	47	51	46	46	39	46	46	46	46	46	39	60	559	65	90%
Total Personnel	567,210	47,261	42,939	45,994	45,281	42,962	46,535	45,155	48,187	45,663	56,481	41,791	50,605	558,855	8,355	99%
Office Expense and Supplies	9,000	259	685	292	498	832	918	779	244	627	296	553	823	6,804	2,196	76%
Postage	2,805	0	0	0	0	0	0	0	57	1,009	0	0	0	1,065	1,740	38%
Tools and Supplies	6,000	429	103	407	1,141	2,448	342	45	217	269	87	657	117	6,262	(262)	104%
Uniforms	4,500	862	54	489	1,079	219	205	448	221	126	221	295	375	4,594	(94)	102%
Building Modifications	500	0	0	0	0	0	0	0	0	0	0	0	0	0	500	0%
Building & Property Maint	5,500	273	336	638	1,424	178	1,433	10,610	12,242	12,281	(35,557)	178	547	4,582	918	83%
Utilities	2,700	237	257	2,637	(2,040)	282	273	252	220	237	251	253	260	3,119	(419)	116%
Telephone	35,000	2,835	2,846	2,886	2,784	2,757	2,752	2,808	6,101	2,910	2,908	2,901	2,907	37,395	(2,395)	107%
Legal Fees	100,000	5,436	4,851	5,064	6,233	11,276	10,959	4,073	11,334	15,130	13,569	5,935	7,782	101,641	(1,641)	102%
Property Insurance	1,310	112	112	112	112	112	112	112	112	112	112	112	112	1,344	(34)	103%
Advertising/Drug Testing	0	0	0	0	0	0	0	0	0	0	0	0	0	0	-	#DIV/0!
Dues/Subscriptions	9,400	4,994	548	373	373	373	373	373	373	373	373	1,059	383	9,968	(568)	106%
Liability Insurance	580	38	38	38	38	38	38	38	38	38	38	38	38	456	124	79%
Service Contracts	150,000	1,933	2,290	5,314	892	3,502	113,842	0	5,000	231	5,200	3,061	61	141,328	8,672	94%
Support Activities	11,500	1,122	4,873	292	3,141	0	192	60	0	0	0	0	0	9,680	1,820	84%
Equipment Rental/Lease	13,000	369	1,475	189	369	932	189	369	658	189	189	961	189	6,077	6,923	47%
Seminars/Training	2,000	230	0	0	1,383	0	0	0	50	(633)	0	0	0	1,030	970	52%

City of Socorro
 Unaudited Budget Vs Expenditures
 General Fund
 For October 1, 2019 through September 30, 2020

<i>Expenditures-City Manager</i>															Budgeted	
Account Title	Budget	Oct-19	Nov-19	Dec-19	Jan-20	Feb-20	Mar-20	Apr-20	May -20	June -20	July -20	Aug -20	Sept -20	YTD Actual	Balance	Per. Of Bud
Marketing Exp	0	0	0	0	0	0	0	0	0	0	0	0	0	0	-	#DIV/0!
Vehicle Repair & Maintenance	3,000	232	135	110	0	287	62	0	0	259	81	0	0	1,166	1,834	39%
Vehicle Fuel	3,350	88	90	510	388	623	428	49	178	402	641	178	379	3,953	(603)	118%
Equipment Repair & Maint	2,000	0	0	0	0	0	32	0	84	0	0	26	0	142	1,858	7%
Travel/Mileage/Per Diem	8,000	689	640	951	566	2,709	363	605	(301)	557	600	641	615	8,635	(635)	108%
Property and Equipment	2,000	1,229	0	0	0	0	0	0	0	230	(230)	0	0	1,229	771	61%
Emergency Aid and Assist	5,000	0	0	0	0	0	9,426	16,520	5,315	16,130	(47,391)	0	0	0	5,000	0%
Contingency	0	0	0	0	0	0	0	0	0	0	0	0	0	0	-	#DIV/0!
Settlements	0	0	0	0	0	0	0	0	0	0	0	0	0	0	-	#DIV/0!
Total Operating	377,145	21,366	19,331	20,302	18,380	26,567	141,939	37,141	42,141	50,477	(58,613)	16,850	14,588	350,469	26,676	93%
Total Expenses	944,355	68,627	62,271	66,295	63,661	69,529	188,474	82,296	90,328	96,140	(2,132)	58,641	65,194	909,324	35,031	96%

City of Socorro
 Unaudited Budget Vs Expenditures
 General Fund
 For October 1, 2019 through September 30, 2020

<i>Expenditures-Parks and Public Works</i>															Budgeted	
Account Title	Budget	Oct-19	Nov-19	Dec-19	Jan-20	Feb-20	Mar-20	Apr-20	May -20	June -20	July -20	Aug -20	Sept -20	YTD Actual	Balance	Per. Of Bud
Salaries	698,954	52,794	56,786	57,985	60,215	55,187	59,054	64,147	68,294	55,414	57,873	48,071	60,859	696,678	2,276	100%
Overtime	23,040	1,756	3,274	4,873	553	791	928	421	688	582	1,198	1,139	2,046	18,250	4,790	79%
FICA/Medicare Taxes	54,932	4,173	4,595	4,772	4,584	4,220	4,519	4,872	5,210	4,221	4,455	3,712	4,740	54,073	859	98%
T.W.C. Payroll Taxes	3,888	1	7	38	61	248	2,371	985	104	47	12	(22)	0	3,852	36	99%
Health Insurance Premiums	214,000	14,270	14,270	14,919	14,919	15,567	18,162	16,216	16,865	16,865	15,567	16,216	14,919	188,754	25,246	88%
Workers Compensation Ins	51,500	4,437	4,437	4,437	4,437	4,437	4,437	4,437	4,437	3,212	(7,309)	3,212	3,212	37,823	13,677	73%
Deferred Compensation	25,000	2,181	2,132	2,280	2,318	2,006	2,145	2,112	2,091	2,068	2,009	1,665	2,103	25,109	(109)	100%
Life Insurance	1,371	138	86	105	116	81	127	84	84	111	94	23	94	1,142	229	83%
Dental Insurance Expense	7,300	424	403	488	499	437	636	527	527	484	434	924	(92)	5,691	1,609	78%
Vision Insurance Expense	1,575	96	92	101	105	91	130	101	106	110	97	95	92	1,215	360	77%
Total Personnel	1,081,560	80,270	86,081	89,998	87,808	83,064	92,507	93,901	98,406	83,113	74,430	75,036	87,973	1,032,587	48,973	95%
Office Expense and Supplies	7,500	601	847	809	373	360	345	2,377	(160)	685	(1,890)	1,407	209	5,963	1,537	80%
Tools and Supplies	22,500	7,506	6,716	3,173	17	348	131	620	51	662	1,402	3,824	782	25,232	(2,732)	112%
Uniforms	25,200	5,363	1,426	1,287	1,773	986	2,618	3,932	964	1,291	1,415	1,145	938	23,139	2,061	92%
Building & Property Maint	7,500	345	330	297	768	1,170	1,162	262	338	351	(20)	5,077	279	10,360	(2,860)	138%
Street Maintenance	65,000	2,295	8,164	6,903	1,498	5,104	2,017	4,411	4,325	5,756	8,779	8,569	4,322	62,143	2,857	96%
Utilities	240,000	23,450	17,668	18,688	17,090	17,677	17,804	18,094	20,434	25,049	26,402	32,871	27,673	262,901	(22,901)	110%
Telephone	22,500	1,394	1,395	1,393	206	397	333	336	334	338	337	324	325	7,113	15,387	32%
Park Maintenance	11,000	547	624	0	36	1,113	389	285	2,147	84	469	54	0	5,749	5,251	52%
Recycling Center	10,000	690	690	0	690	690	1,380	0	1,380	690	0	1,380	205	7,795	2,205	78%
Legal Fees	17,000	1,147	860	22	1,522	2,219	(405)	3,015	816	2,031	2,558	4,328	3,647	21,760	(4,760)	128%
Property Insurance	20,000	1,672	1,672	1,672	2,217	1,672	1,672	1,672	1,672	1,672	1,672	1,672	1,672	20,609	(609)	103%
Dues/Subscriptions	0	0	0	0	0	0	0	0	0	0	0	0	0	0	-	#DIV/0!
Liability Insurance	17,800	1,471	1,471	1,471	2,348	1,471	1,471	1,471	1,471	1,471	1,471	1,471	1,471	18,529	(729)	104%
Service Contracts	50,000	7,948	15,921	2,300	2,552	439	1,421	439	3,788	2,392	519	3,349	1,421	42,490	7,510	85%
Equipment Rental/Lease	9,000	86	201	86	86	2,325	86	223	169	86	86	86	171	3,688	5,312	41%

City of Socorro
 Unaudited Budget Vs Expenditures
 General Fund
 For October 1, 2019 through September 30, 2020

<i>Expenditures-Public Works</i>																
Account Title	Budget	Oct-19	Nov-19	Dec-19	Jan-20	Feb-20	Mar-20	Apr-20	May -20	June -20	July -20	Aug -20	Sept -20	YTD Actual	Budgeted Balance	Per. Of Bud
Seminars/Training	1,000	0	0	0	675	100	0	0	0	0	0	115	0	890	110	89%
Office Furniture	500	400	0	0	0	0	0	0	0	0	0	0	0	400	100	80%
Radio Communications	0	0	0	0	0	0	0	0	0	0	0	0	0	0	-	#DIV/0!
Vehicle Repair & Maint	20,000	202	317	1,016	614	1,608	447	3,154	337	900	120	1,171	391	10,276	9,724	51%
Equipment Repair & Maint	42,000	2,915	2,527	2,488	3,352	4,745	2,408	2,015	1,869	4,322	3,370	2,391	4,245	36,648	5,352	87%
Vehicle Fuel	42,250	3,305	3,300	2,506	2,551	2,255	2,639	1,237	1,621	2,961	2,860	2,337	1,317	28,890	13,360	68%
Travel/Mileage/Per Diem	500	16	14	1	0	5	5	21	16	6	0	0	0	83	417	17%
Property and Equipment	10,000	0	0	0	0	0	0	0	0	0	0	0	0	0	10,000	0%
Emergency Aid and Assist	5,000	0	0	0	0	0	0	0	0	0	0	0	0	0	5,000	0%
Total Operating	646,250	61,354	64,144	44,114	38,368	44,683	35,924	43,565	41,570	50,746	49,550	71,571	49,069	594,658	51,592	92%
Total Expenses	1,727,810	141,624	150,224	134,112	126,175	127,748	128,431	137,466	139,976	133,859	123,980	146,607	137,042	1,627,245	100,565	94%

City of Socorro
 Unaudited Budget Vs Expenditures
 General Fund
 For October 1, 2019 through September 30, 2020

Expenditures-Police															Budgeted	
Account Title	Budget	Oct-19	Nov-19	Dec-19	Jan-20	Feb-20	Mar-20	Apr-20	May -20	June -20	July -20	Aug -20	Sept -20	YTD Actual	Balance	Per. Of Bud
Salaries	2,207,907	171,844	172,365	178,562	183,063	168,333	179,990	192,512	199,426	180,589	189,101	160,679	208,416	2,184,881	23,026	99%
Overtime	270,000	30,032	32,921	27,309	24,457	13,972	8,819	8,552	22,861	16,684	21,068	10,769	32,406	249,851	20,149	93%
FICA/Medicare Taxes	189,505	15,444	15,704	15,488	15,383	14,414	13,952	15,044	16,465	14,570	15,545	13,085	17,909	183,004	6,501	97%
T.W.C. Payroll Taxes	8,088	3	0	118	182	196	3,921	2,131	161	119	205	97	23	7,155	933	88%
Health Insurance Premiums	414,280	29,518	29,518	29,518	29,518	28,100	28,088	29,385	31,527	31,700	31,700	28,835	32,998	360,407	53,873	87%
Workers Compensation	62,975	2,961	2,961	2,961	2,961	2,961	2,961	1,083	2,961	2,961	2,336	2,285	2,918	32,310	30,665	51%
Deferred Compensation	52,000	4,743	4,483	4,550	4,657	3,855	4,371	5,894	4,470	4,508	4,231	4,262	5,006	55,030	(3,030)	106%
Life Insurance	4,733	444	350	382	382	294	367	379	396	396	395	279	400	4,463	270	94%
Dental Insurance Expense	15,476	1,087	1,154	1,111	1,111	829	1,065	1,111	1,189	981	1,086	2,472	(598)	12,598	2,878	81%
Vision Insurance Expense	3,339	211	204	206	206	176	197	206	220	220	229	179	211	2,466	873	74%
Total Personnel	3,228,303	256,286	259,663	260,206	261,921	233,130	243,731	256,298	279,676	252,728	265,896	222,943	299,689	3,092,164	136,139	96%
Office Expense and Supplies	18,000	1,274	706	3,704	2,467	892	4,270	4,933	512	2,004	(3,541)	583	231	18,036	(36)	100%
Medical Supplies	500	93	0	0	0	0	0	81	0	127	(127)	281	0	455	45	91%
Postage	1,300	0	0	0	0	0	0	0	1,008	72	0	0	0	1,080	220	83%
Tools and Supplies	56,000	773	4,898	1,040	39	12,558	5,085	1,495	4,625	9,306	4,020	9,848	980	54,668	1,332	98%
Uniforms	25,000	3,377	1,843	368	270	2,980	1,065	1,630	4,157	312	1,030	1,424	3,403	21,860	3,140	87%
Building & Property Maint	24,000	416	611	191	330	2,220	2,882	492	2,697	968	1,208	2,175	1,470	15,662	8,338	65%
Utilities	55,000	2,717	2,250	4,504	3,090	4,989	4,520	4,145	14,302	4,183	4,658	4,912	4,842	59,112	(4,112)	107%
Telephone	48,000	4,720	4,687	4,838	2,764	2,927	3,069	3,177	3,378	7,463	7,461	7,485	7,496	59,465	(11,465)	124%
Legal Fees	25,000	0	0	1,169	353	906	201	315	287	1,081	1,213	110	397	6,032	18,968	24%
Property Insurance	12,000	1,021	1,021	1,021	1,003	1,021	1,021	1,021	1,021	1,021	1,021	1,021	1,021	12,234	(234)	102%
Dues/Subscriptions	2,000	0	705	0	0	380	(190)	0	240	51	95	0	0	1,281	719	64%
Liability Insurance	66,000	3,574	3,424	3,753	16,530	3,424	3,424	3,424	3,424	3,424	3,424	3,424	3,424	54,673	11,327	83%
Service Contracts	32,000	1,311	1,845	6,579	5,307	893	1,370	3,954	2,842	2,002	3,254	1,693	1,813	32,863	(863)	103%
Support Activities	2,500	104	43	0	405	(405)	0	0	0	0	0	29	0	176	2,324	7%

City of Socorro
 Unaudited Budget Vs Expenditures
 General Fund
 For October 1, 2019 through September 30, 2020

<i>Expenditures-Police</i>															Budgeted	
Account Title	Budget	Oct-19	Nov-19	Dec-19	Jan-20	Feb-20	Mar-20	Apr-20	May -20	June -20	July -20	Aug -20	Sept -20	YTD Actual	Balance	Per. Of Bud
Equipment Rental/Lease	8,500	650	481	660	649	451	385	1,141	823	831	785	1,300	635	8,791	(291)	103%
Seminars/Training	10,000	283	620	410	1,334	288	995	1,881	0	2,194	0	1,469	5,404	14,877	(4,877)	149%
Radio Comm & Maint	1,500	0	0	0	0	0	485	439	0	251	0	0	0	1,174	326	78%
Vehicle Repair & Maint	48,000	3,313	1,760	1,262	2,778	1,003	2,301	3,284	4,467	9,912	4,509	11,271	6,097	51,956	(3,956)	108%
Equipment Repair & Maint	6,000	1,250	0	0	0	0	0	0	0	0	0	0	2,632	3,882	2,118	65%
Vehicle Fuel	57,000	6,569	6,500	5,431	5,821	4,772	5,193	2,361	3,251	3,739	4,506	4,286	2,108	54,536	2,464	96%
Travel/Mileage/Per Diem	15,000	1,765	2,028	1,493	582	108	753	51	289	124	82	674	738	8,688	6,312	58%
Property & Equipment Settlements	243,200	0	0	0	0	790	0	17,778	0	0	0	83,343	62,982	164,894	78,306	68%
	0	0	0	0	0	0	0	0	0	0	0	1,341	(1,341)	0	-	#DIV/0!
Total Operating	756,500	33,208	33,422	36,424	43,723	40,197	36,830	51,603	47,323	49,064	33,597	136,670	104,334	646,395	110,105	85%
Total Expenses	3,984,803	289,494	293,084	296,630	305,644	273,327	280,560	307,901	326,999	301,791	299,493	359,612	404,023	3,738,559	246,244	94%

City of Socorro
 Unaudited Budget Vs Expenditures
 General Fund
 For October 1, 2019 through September 30, 2020

<i>Expenditures-Municipal Court</i>															Budgeted	
Account Title	Budget	Oct-19	Nov-19	Dec-19	Jan-20	Feb-20	Mar-20	Apr-20	May -20	June -20	July -20	Aug -20	Sept -20	YTD Actual	Balance	Per. Of Bud
Salaries	203,101	16,294	16,685	17,215	17,330	16,134	17,156	17,388	18,961	16,570	17,169	14,924	18,826	204,652	(1,551)	101%
Overtime	4,855	203	366	429	414	525	425	48	100	481	185	236	449	3,860	995	79%
FICA/Medicare Taxes	15,523	1,262	1,304	1,342	1,343	1,260	1,330	1,319	1,443	1,290	1,313	1,146	1,454	15,808	(285)	102%
T.W.C. Payroll Taxes	730	0	0	10	17	36	487	171	0	0	0	0	0	722	8	99%
Health Insurance Premiums	43,800	1,946	1,946	2,595	2,595	2,595	2,595	2,595	2,595	2,595	2,595	2,595	2,595	29,837	13,963	68%
Workers Compensation	1,885	46	46	46	46	46	46	46	46	46	46	46	46	552	1,333	29%
Deferred Compensation	3,300	218	252	260	291	243	260	287	260	293	260	227	285	3,137	163	95%
Life Insurance	501	21	63	40	40	10	40	40	40	40	40	10	40	427	74	85%
Dental Insurance Expense	1,460	71	83	119	119	97	119	119	119	103	107	235	(41)	1,251	209	86%
Vision Insurance Expense	315	14	20	23	23	20	23	23	23	23	23	20	23	258	57	82%
Total Personnel	275,470	20,074	20,765	22,078	22,219	20,966	22,482	22,037	23,588	21,441	21,738	19,438	23,678	260,503	14,967	95%
Office Expense and Supplies	14,000	273	282	3,495	259	926	440	4,598	237	342	650	426	1,692	13,619	381	97%
Postage	3,500	1,389	0	0	(12)	(1,378)	0	0	0	1,716	0	0	1,009	2,723	777	78%
Uniforms	0	0	0	0	0	0	0	0	0	0	0	0	0	0	-	#DIV/0!
Building & Property Maint	2,000	170	33	163	237	46	0	75	75	0	75	75	75	1,023	977	51%
Telephone	11,450	647	646	1,100	191	644	671	667	1,362	741	741	713	714	8,839	2,611	77%
Legal Fees	13,000	1,475	1,766	1,630	429	400	(400)	0	2,384	1,600	0	0	1,647	10,932	2,068	84%
Property Insurance	4,100	324	324	324	324	324	324	324	324	324	324	324	324	3,888	212	95%
Advertising/Drug Testing	0	0	0	0	0	0	0	0	0	0	0	0	0	0	-	#DIV/0!
Dues/Subscriptions	500	0	207	0	0	0	0	0	0	0	0	0	0	207	293	41%
Liability Insurance	570	36	36	36	36	36	36	36	36	36	36	36	36	432	138	76%
Service Contracts	60,000	8,733	3,542	3,542	3,673	3,542	3,542	3,542	3,809	3,617	3,542	3,542	3,542	48,165	11,835	80%
Support Activities	3,000	1,881	698	0	0	149	0	0	0	0	0	0	0	2,729	271	91%
Equipment Rental/Lease	2,500	139	450	139	139	450	0	139	450	139	319	589	139	3,091	(591)	124%
Seminars/Training	1,300	27	674	0	0	0	0	0	0	0	0	0	0	700	600	54%

City of Socorro
 Unaudited Budget Vs Expenditures
 General Fund
 For October 1, 2019 through September 30, 2020

<i>Expenditures-Municipal Court</i>															Budgeted	
Account Title	Budget	Oct-19	Nov-19	Dec-19	Jan-20	Feb-20	Mar-20	Apr-20	May -20	June -20	July -20	Aug -20	Sept -20	YTD Actual	Balance	Per. Of Bud
Office Furniture	0	0	0	0	0	0	0	0	0	0	0	0	0	0	-	#DIV/0!
Equipment Repair & Maint	0	0	0	0	0	0	0	0	0	0	0	0	0	0	-	#DIV/0!
Travel/Mileage/Per Diem	2,600	0	1,083	600	5	7	26	0	0	1	5	0	15	1,743	857	67%
Property And Equipment	6,000	0	0	0	0	0	0	0	0	3,429	0	0	3,301	6,730	(730)	112%
Total Operating	124,520	15,093	9,741	11,029	5,281	5,145	4,639	9,380	8,677	11,945	5,691	5,705	12,494	104,819	19,701	84%
Total Expenses	399,990	35,167	30,506	33,107	27,500	26,111	27,121	31,417	32,265	33,387	27,429	25,143	36,171	365,323	34,667	91%

City of Socorro
Unaudited Budget Vs Expenditures
General Fund
For October 1, 2019 through September 30, 2020

<i>Expenditures-Planning & Zoning</i>															Budgeted	
Account Title	Budget	Oct-19	Nov-19	Dec-19	Jan-20	Feb-20	Mar-20	Apr-20	May-20	June-20	July-20	Aug-20	Sept-20	YTD Actual	Balance	Per. Of Bud
Salaries	375,728	33,917	31,586	32,510	30,250	27,324	29,407	31,265	32,023	31,490	32,760	30,105	38,455	381,091	(5,363)	101%
Overtime	5,624	203	123	212	334	666	556	494	292	163	205	618	581	4,448	1,176	79%
FICA/Medicare Taxes	29,640	2,610	2,426	2,464	2,270	2,077	2,223	2,357	2,405	2,354	2,452	2,287	2,878	28,804	836	97%
T.W.C. Payroll Taxes	1,164	0	0	18	22	58	666	344	47	0	7	54	81	1,297	(133)	111%
Health Insurance Premiums	73,840	5,878	5,878	5,878	5,878	5,638	5,878	5,229	4,580	4,580	4,580	4,341	4,580	62,918	10,922	85%
Workers Compensation	1,885	150	150	150	150	150	150	150	150	150	150	150	150	1,800	85	95%
Deferred Compensation	14,000	1,228	1,189	1,228	1,125	999	1,119	1,189	1,228	1,189	1,228	1,070	1,347	14,139	(139)	101%
Life Insurance	505	47	43	43	42	20	120	109	(165)	31	31	(30)	31	320	185	63%
Dental Insurance Expense	2,628	221	221	221	221	144	221	174	138	142	154	362	(107)	2,111	517	80%
Vision Insurance Expense	567	38	38	38	37.68	27	38	38	26	33	33	26	33	403	164	71%
Total Personnel	505,581	44,293	41,652	42,761	40,329	37,103	40,377	41,349	40,725	40,132	41,600	38,982	48,029	497,331	8,250	98%
Office Expense and Supplies	12,500	924	51	540	499.86	66	704	845	804	1,273	2,056	1,294	2,817	11,875	625	95%
Postage	6,500	453	51	504	0	504	504	0	504	0	363	0	807	3,687	2,813	57%
Tools and Supplies	1,300	136	0	0	0	0	382	0	0	0	(382)	105	176	417	883	32%
Uniforms	2,700	0	1,332	0	0	38	572	0	0	0	0	295	660	2,898	(198)	107%
Building & Property Maint	8,000	75	75	75	130	75	75	0	0	0	38	0	71	613	7,387	8%
Utilities	4,000	41	41	417	41	416	416	655	967	41	41	85	41	3,202	798	80%
Telephone	18,000	1,062	1,061	1,137	605	682	706	714	895	1,265	1,082	1,169	1,170	11,549	6,451	64%
Legal Fees	88,000	5,826	7,100	11,102	6,691	20,501	(865)	6,010	6,118	9,992	4,819	5,152	4,164	86,611	1,389	98%
Property Insurance	1,800	150	150	150	150	150	150	150	150	150	150	150	150	1,800	-	100%
Advertising/Drug Testing	9,000	215	0	111	0	0	0	519	493	3,722	0	0	0	5,060	3,940	56%
Dues/Subscriptions	1,200	0	0	0	25	100	0	15	0	30	(45)	0	75	200	1,000	17%
Liability Insurance	4,900	312	312	312	312	312	312	312	312	312	312	312	312	3,744	1,156	76%
Service Contracts	344,000	8,552	10,074	9,239	26,384	17,072	71,481	17,917	26,295	28,556	32,403	14,351	12,647	274,973	69,027	80%
Support Activities	0	0	0	0	0	0	0	0	0	0	0	0	0	0	-	#DIV/0!

City of Socorro
 Unaudited Budget Vs Expenditures
 General Fund
 For October 1, 2019 through September 30, 2020

<i>Expenditures-Planning & Zoning</i>															Budgeted	
Account Title	Budget	Oct-19	Nov-19	Dec-19	Jan-20	Feb-20	Mar-20	Apr-20	May -20	June -20	July -20	Aug -20	Sept -20	YTD Actual	Balance	Per. Of Bud
Equipment Rental/Lease	10,500	475	358	835	475.00	358	847	745	358	664	358	745	1,260	7,478	3,022	71%
Seminars/Training	4,250	100	0	400	400.00	1,680	0	(740)	75	0	25	1,161	0	3,101	1,149	73%
Office Furniture	1,000	0	0	0	0	0	0	0	0	0	0	0	0	0	1,000	0%
Vehicle Repair & Maint	2,300	0	75	146	15.00	263	135	140	0	0	107	0	238	1,118	1,182	49%
Equipment Repair & Maint	3,000	0	0	0	0.00	0	0	0	23	0	0	0	0	23	2,977	1%
Vehicle Fuel	4,000	292	300	95	188.99	176	78	23	58	169	122	279	144	1,926	2,074	48%
Travel/Mileage/Per Diem	1,000	13	0	0	234.96	457	5	0	0	0	0	0	0	710	290	71%
Property and Equipment	19,000	1,707	0	1,008	0.00	0	0	0	1,713	4,045	(465)	2,919	0	10,926	8,074	58%
Settlements	0	0	0	0	0.00	0	0	0	0	0	0	0	0	0	-	#DIV/0!
Total Operating	546,950	20,333	20,980	26,071	36,152	42,851	75,503	27,306	38,765	50,219	40,982	28,018	24,731	431,911	115,039	79%
Total Expenses	1,052,531	64,626	62,632	68,832	76,480	79,954	115,880	68,654	79,491	90,350	82,582	67,001	72,760	929,242	123,289	88%

City of Socorro
 Unaudited Budget Vs Expenditures
 General Fund
 For October 1, 2019 through September 30, 2020

<i>Expenditures-Health Dept.</i>																
Account Title	Budget	Oct-19	Nov-19	Dec-19	Jan-20	Feb-20	Mar-20	Apr-20	May -20	June -20	July -20	Aug -20	Sept -20	YTD Actual	Budgeted Balance	Per. Of Bud
	0	0	0	0	0	0	0	0	0	0	0	0	0	0	-	0%
Total Personnel	0	0	0	0	0	0	0	0	0	0	0	0	0	0	-	0%
Health Contract	600,000	0	23,706	7,428	5,676	143,602	52,857	145,252	5,833	13,749	9,643	12,175	10,723	430,645	169,355	72%
Total Operating	600,000	0	23,706	7,428	5,676	143,602	52,857	145,252	5,833	13,749	9,643	12,175	10,723	430,645	169,355	72%
Total Expenses	600,000	0	23,706	7,428	5,676	143,602	52,857	145,252	5,833	13,749	9,643	12,175	10,723	430,645	169,355	72%

<i>Expenditures-Grants</i>																
Account Title	Budget	Oct-19	Nov-19	Dec-19	Jan-20	Feb-20	Mar-20	Apr-20	May -20	June -20	July -20	Aug -20	Sept -20	YTD Actual	Budgeted Balance	Per. Of Bud
Salaries	56,055	4,335	4,204	4,969	5,867	4,379	4,344	4,203	4,344	4,305	5,535	4,891	6,363	57,738	(1,683)	103%
FICA/Medicare Taxes	5,436	332	322	361	415	303	298	288	298	297	390	345	450	4,097	1,339	75%
T.W.C. Payroll Taxes	202	0	0	3	6	3	127	46	0	2	19	18	26	248	(46)	123%
Health Insurance Premiums	8,760	679	679	679	679	496	679	679	679	679	679	496	679	7,784	976	89%
Workers Compensation	233	0	0	0	0	0	0	0	0	0	0	0	0	0	233	0%
Deferred Compensation Benefits	2,650	214	208	215	215	201	215	208	215	208	215	187	236	2,536	114	96%
Life Insurance	150	9	9	9	9	9	9	9	9	9	9	9	9	109	41	73%
Dental Insurance Expense	292	26	26	26	26	9	26	26	26	20	23	62	(30)	265	27	91%
Vision Insurance Expense	63	5	5	5	5	3	5	5	5	5	5	3	5	54	9	86%
Total Personnel	73,841	5,600	5,452	6,267	7,222	5,402	5,702	5,464	5,576	5,524	6,874	6,010	7,737	72,830	-	0%
Office Expense and Supplies	1,000	0	200	266	0	0	326	55	0	0	25	54	0	926	74	93%
Postage	300	0	33	11	0	0	0	14	0	14	0	0	0	72	228	24%
Uniforms	300	144	0	0	0	0	0	0	0	0	0	38	16	198	102	66%
Telephone	500	50	50	37	41	41	41	41	41	42	42	40	40	509	(9)	102%
Legal Fees	1,000	0	0	0	0	0	0	0	0	0	0	0	0	0	1,000	0%
Advertising/Drug Testing	500	0	0	0	0	0	0	0	0	0	0	0	0	0	500	0%
Dues/Subscriptions	550	0	0	174	0	25	0	300	0	21	(129)	21	21	433	117	79%
Service Contracts	1,000	0	0	0	0	0	0	0	0	0	0	0	0	0	1,000	0%
Seminars/Training	4,000	0	700	808	0	31	0	104	0	0	985	1,122	0	3,750	250	94%
Travel/Mileage/Per Diem	3,500	1,635	847	426	128	11	98	0	0	0	0	0	57	3,200	300	91%
Property and Equipment	2,950	720	0	0	0	0	559	0	0	0	0	1,290	0	2,569	381	87%
Grant Expense	0	0	0	0	0	0	0	0	0	0	0	0	0	0	-	#DIV/0!
Total Operating	15,600	2,549	1,830	1,722	169	108	1,025	514	41	77	923	2,565	134	11,657	3,943	75%
Total Expenses	89,441	8,149	2,676	2,148	297	119	1,122	514	41	5,601	7,797	8,575	7,871	84,487	3,943	94%

City of Socorro
 Unaudited Budget Vs Expenditures
 General Fund
 For October 1, 2019 through September 30, 2020

<i>Expenditures-Human Resources</i>															Budgeted	
Account Title	Budget	Oct-19	Nov-19	Dec-19	Jan-20	Feb-20	Mar-20	Apr-20	May -20	June -20	July -20	Aug -20	Sept -20	YTD Actual	Balance	Per. Of Bud
Salaries	0	0	0	0	0	0	0	0	0	0	0	0	0	0	-	#DIV/0!
FICA/Medicare Taxes	0	0	0	0	0	0	0	0	0	0	0	0	0	0	-	#DIV/0!
T.W.C. Payroll Taxes	0	0	0	0	0	0	0	0	0	0	0	0	0	0	-	#DIV/0!
Health Insurance Premiums	0	0	0	0	0	0	0	0	0	0	0	0	0	0	-	#DIV/0!
Workers Compensation	144	12	12	12	12	12	12	12	12	0	0	0	0	96	48	67%
Deferred Compensation	0	0	0	0	0	0	0	0	0	0	0	0	0	0	-	#DIV/0!
Life Insurance	0	0	0	0	0	0	0	0	0	0	0	0	0	0	-	#DIV/0!
Dental Insurance Expense	0	0	0	0	0	0	0	0	0	0	0	0	0	0	-	#DIV/0!
Employee Assistance Program	4,820	4,820	0	0	0	0	0	0	0	0	0	0	0	4,820	-	100%
Vision Insurance Expense	0	0	0	0	0	0	0	0	0	0	0	0	0	0	-	#DIV/0!
Total Personnel	4,964	4,832	12	12	12	12	12	12	12	0	0	0	0	4,916	48	99%
Office Expense and Supplies	2,210	0	180	325	0	331	0	12	0	0	117	0	0	965	1,245	44%
Postage	210	0	0	0	0	0	0	0	0	0	0	0	0	0	210	0%
Telephone	0	0	0	0	0	0	0	0	0	0	0	0	0	0	-	#DIV/0!
Property Insurance	44	4	4	4	4	4	4	4	4	4	4	4	4	48	(4)	109%
Legal Fees	15,000	1,147	176	243	1,246	1,667	1,005	968	2,294	375	6,129	2,150	154	17,553	(2,553)	117%
Advertising/Drug Testing	7,000	278	735	1,716	323	955	687	0	0	922	625	395	171	6,805	195	97%
Dues/Subscriptions	1,000	0	0	117	180	0	0	0	0	0	0	0	0	297	703	30%
Liability Insurance	450	29	29	29	29	29	29	29	29	29	29	29	29	348	102	77%
Service Contracts	45,000	882	1,645	6,000	3,000	3,000	4,005	3,000	3,000	3,000	3,000	0	0	30,532	14,468	68%
Support Activities	500	28	0	235	40	101	0	19	0	0	0	0	327	750	(250)	150%
Seminars/Training	504	0	0	250	887	0	0	0	(633)	0	0	0	0	504	-	100%
Equipment Repair & Maint	0	0	0	0	0	0	0	0	0	0	0	0	0	0	-	#DIV/0!
Travel/Mileage/Per Diem	1,400	0	0	324	816	1,696	(275)	0	(1,239)	0	0	0	0	1,323	77	95%
Human Resources	8,750	0	0	0	1,500	0	1,500	0	0	1,500	2,400	500	0	7,400	1,350	85%
Total Operating	82,068	2,368	2,769	9,243	8,025	7,784	6,956	4,031	3,454	5,829	12,304	3,078	685	66,526	15,542	81%
Total Expenses	87,032	7,200	2,781	9,255	8,037	7,796	6,968	4,043	3,466	5,829	12,304	3,078	685	71,442	15,590	82%

City of Socorro
 Unaudited Budget Vs Expenditures
 General Fund
 For October 1, 2019 through September 30, 2020

<i>Expenditures-Mayor & Council</i>															Budgeted	
Account Title	Budget	Oct-19	Nov-19	Dec-19	Jan-20	Feb-20	Mar-20	Apr-20	May -20	June -20	July -20	Aug -20	Sept -20	YTD Actual	Balance	Per. Of Bud
Salaries	55,022	4,685	4,534	4,685	4,685	4,383	4,685	4,534	4,685	4,534	4,685	4,080	5,139	55,313	(291)	101%
FICA/Medicare Taxes	4,974	358	347	353	349	327	349	338	349	338	350	305	384	4,147	827	83%
T.W.C. Payroll Taxes	576	3	1	3	5	20	194	111	75	73	67	48	60	659	(83)	114%
Health Insurance Premiums	36,560	2,595	2,595	2,595	2,595	2,595	2,595	2,595	2,595	2,595	2,595	2,595	2,595	31,135	5,425	85%
Workers Compensation	300	0	0	0	0	0	0	0	0	0	0	0	0	0	300	0%
Deferred Compensation	3,000	149	144	149	149	139	149	144	149	144	149	130	164	1,760	1,240	59%
Life Insurance	210	14	9	9	9	3	9	9	9	9	9	3	9	101	109	48%
Dental Insurance Expense	1,752	65	98	98	98	66	98	98	98	81	88	204	(56)	1,034	718	59%
Vision Insurance Expense	378	22	24	24	24	17	24	24	24	24	24	17	24	269	109	71%
Total Personnel	102,772	7,891	7,751	7,915	7,913	7,550	8,102	7,852	7,983	7,798	7,966	7,380	8,316	94,418	8,354	92%
Office Expense and Supplies	3,500	175	520	58	10	416	103	0	0	45	370	250	378	2,324	1,176	66%
Uniforms	0	0	0	0	0	0	0	0	0	0	0	0	0	0	-	#DIV/0!
Telephone	3,600	410	410	408	408	408	407	558	322	427	61	314	314	4,445	(845)	123%
Property Insurance	220	19	19	19	19	19	19	19	19	19	19	19	19	228	(8)	104%
Liability Insurance	2,300	143	143	143	143	143	143	143	143	143	143	143	143	1,716	584	75%
Dues/Subscriptions	5,000	3,489	0	0	0	100	0	15	596	15	(45)	0	0	4,170	830	83%
Advertising Drug Testing	0	0	0	0	0	0	0	0	0	0	0	0	0	0	-	#DIV/0!
Seminars/Training	3,000	200	1,705	0	0	235	0	0	0	0	0	0	0	2,140	860	71%
Office Furniture	0	0	0	0	0	0	0	0	0	0	0	0	0	0	-	#DIV/0!
Travel/Mileage/Per Diem	8,000	2,595	2,571	1,490	(34)	(133)	645	19	0	0	0	0	0	7,153	847	89%
Settlements	220	220	0	0	0	0	0	0	0	0	0	0	0	220	-	100%
Total Operating	25,840	7,250	5,368	2,117	546	1,188	1,317	754	1,080	649	548	727	854	22,397	3,443	87%
Total Expenses	128,612	15,141	13,119	10,032	8,458	8,738	9,419	8,606	9,063	8,447	8,514	8,107	9,170	116,814	11,798	91%

City of Socorro
 Unaudited Budget Vs Expenditures
 General Fund
 For October 1, 2019 through September 30, 2020

Expenditures-City Clerk Account Title	Budget	Oct-19	Nov-19	Dec-19	Jan-20	Feb-20	Mar-20	Apr-20	May -20	June -20	July -20	Aug -20	Sept -20	YTD Actual	Budgeted	
															Balance	Per. Of Bud
Salaries	56,662	4,765	4,643	4,797	4,797	4,488	4,797	4,736	4,898	4,642	4,797	4,178	5,262	56,799	(137)	100%
FICA/Medicare Taxes	4,370	365	355	367	367	343	367	362	375	355	367	320	403	4,345	25	99%
T.W.C. Payroll Taxes	146	0	0	3	5	2	96	40	0	0	0	0	0	145	1	99%
Health Insurance Premiums	8,760	649	649	649	649	649	649	649	649	649	649	649	649	7,784	976	89%
Workers Compensation	288	23	23	23	23	23	23	23	23	23	23	23	23	276	12	96%
Deferred Compensation	2,800	238	232	240	240	224	240	232	240	242	240	209	263	2,840	(40)	101%
Life Insurance	150	14	14	14	14	(10)	14	14	14	14	14	(10)	14	115	35	77%
Dental Insurance Expense	292	23	23	23	23	23	23	23	23	21	21	42	0	268	24	92%
Vision Insurance Expense	63	5	5	5	5	5	5	5	5	5	5	5	5	54	9	86%
Total Personnel	73,531	6,081	5,943	6,119	6,122	5,746	6,212	6,084	6,225	5,950	6,114	5,413	6,617	72,626	905	99%
Office Expense and Supplies	3,000	104	152	0	0	0	554	0	35	182	0	264	0	1,291	1,709	43%
Postage	200	0	0	0	0	0	0	0	0	0	0	0	0	0	200	0%
Telephone	600	50	50	50	50	50	50	50	50	50	50	48	48	595	5	99%
Legal Fees	16,000	848	840	1,444	343	1,059	1,436	83	1,115	858	546	629	566	9,768	6,232	61%
Property Insurance	96	8	8	8	8	8	8	8	8	8	8	8	8	96	-	100%
Advertising/Drug Testing	28,800	2,991	2,656	1,964	216	0	0	1,585	532	776	968	(1,381)	6,386	16,693	12,107	58%
County Elections	0	0	0	0	0	0	0	0	0	0	0	0	0	0	-	#DIV/0!
Dues/Subscriptions	232	0	0	157	75	0	0	0	0	0	0	0	0	232	-	100%
Liability Insurance	480	31	31	31	31	31	31	31	31	31	31	31	31	372	108	78%
Service Contracts	7,300	0	5,422	0	0	1,164	0	0	0	0	0	0	1,953	8,539	(1,239)	117%
Seminars/Training	1,000	0	0	250	0	0	0	0	0	0	0	0	0	250	750	25%
Travel/Mileage/Per Diem	1,000	0	0	0	1,065	0	0	0	(186)	0	0	0	0	879	121	88%
Settlements	0	0	0	0	0	0	0	0	0	0	0	0	0	0	-	#DIV/0!
Total Operating	58,708	4,032	9,159	3,903	1,788	2,312	2,079	1,757	1,584	1,906	1,604	(401)	8,992	38,715	19,993	66%
Total Expenses	132,239	10,112	15,102	10,023	7,910	8,058	8,292	7,840	7,809	7,856	7,719	5,012	15,609	111,340	20,898	84%

City of Socorro
 Unaudited Budget Vs Expenditures
 General Fund
 For October 1, 2019 through September 30, 2020

<i>Expenditures-Finance</i>																
Account Title	Budget	Oct-19	Nov-19	Dec-19	Jan-20	Feb-20	Mar-20	Apr-20	May -20	June -20	July -20	Aug -20	Sept -20	YTD Actual	Budgeted Balance	Per. Of Bud
Salaries	146,099	12,148	12,796	12,304	12,364	11,551	12,247	12,986	13,442	11,910	12,305	10,711	13,538	148,303	(2,204)	102%
Overtime	2,500	294	155	161	176	84	208	228	193	73	81	101	86	1,839	661	74%
FICA/Medicare Taxes	11,157	952	991	901	863	800	857	918	947	824	852	740	911	10,557	600	95%
T.W.C. Payroll Taxes	438	0	0	7	11	26	285	104	0	0	0	0	0	433	5	99%
Health Insurance Premiums	26,280	2,029	2,029	2,029	2,029	1,529	2,029	2,029	2,029	2,029	2,029	1,529	2,029	23,351	2,929	89%
Workers Compensation	500	35	35	35	35	35	35	35	35	35	35	35	35	420	80	84%
Deferred Compensation	6,600	605	643	611	645	571	611	633	611	742	611	532	670	7,485	(885)	113%
Life Insurance	366	25	25	25	25	25	25	25	25	25	25	25	25	301	65	82%
Dental Insurance Expense	876	74	74	74	74	46	74	74	74	61	66	158	(51)	799	77	91%
Vision Insurance Expense	189	14	14	14	14	11	14	14	14	14	14	11	14	162	27	86%
Total Personnel	195,005	16,176	16,762	16,161	16,238	14,679	16,386	17,046	17,371	15,713	16,019	13,842	17,258	193,650	1,355	99%
Office Expense and Supplies	5,500	520	58	632	419	277	724	344	242	144	142	380	46	3,928	1,572	71%
Telephone	500	50	50	50	50	50	50	50	50	50	50	48	48	595	(95)	119%
Legal Fees	16,100	265	639	0	2,426	4,112	(2,400)	1,710	1,941	3,374	2,602	0	1,456	16,125	(25)	100%
Property Insurance	100	8	8	8	8	8	8	8	8	8	8	8	8	96	4	96%
Audit Fees	37,000	469	0	476	0	10,911	10,312	0	2,938	1,218	0	0	585	26,907	10,093	73%
Central Appraisal Fees	107,000	0	25	29,978	54	19,677	206	20	32	28,111	35	0	27,961	106,098	902	99%
Dues/Subscriptions	8,500	813	688	688	1,108	714	714	714	714	714	714	714	714	9,010	(510)	106%
Bank Charges	28,000	1,050	1,887	1,106	1,074	1,261	1,595	1,707	837	1,963	4,217	2,337	1,515	20,547	7,453	73%
Liability Insurance	5,158	3,891	630	31	31	31	31	31	31	31	31	31	31	4,830	328	94%
Service Contracts	1,000	0	0	0	0	0	0	0	0	0	0	0	0	0	1,000	0%
Tax Collector Fees	13,500	11,030	0	0	0	0	0	0	0	37	0	0	0	11,067	2,433	0%
Seminars/Training	1,000	0	0	0	199	0	0	0	0	0	0	0	0	199	801	20%
Late Charge	550	0	0	12	(12)	0	0	5	9	0	0	0	0	14	536	2%
Travel/Mileage/Per Diem	200	0	0	0	0	10	19	24	23	32	14	19	16	158	42	79%
Property and Equipment	1,900	0	278	0	0	0	0	0	0	0	0	0	960	1,238	662	65%
Settlements	0	0	0	0	0	0	0	0	0	0	0	0	0	0	-	#DIV/0!
Total Operating	226,008	18,095	4,263	32,980	5,356	37,050	11,258	4,613	6,824	35,682	7,813	3,538	33,339	200,811	25,197	89%
Total Expenses	421,013	34,271	21,025	49,141	21,594	51,729	27,644	21,658	24,195	51,396	23,832	17,379	50,597	394,461	26,552	94%

City of Socorro
 Unaudited Budget Vs Expenditures
 General Fund
 For October 1, 2019 through September 30, 2020

<i>Expenditures-Recreational Centers</i>															Budgeted	
Account Title	Budget	Oct-19	Nov-19	Dec-19	Jan-20	Feb-20	Mar-20	Apr-20	May-20	June -20	July -20	Aug -20	Sept -20	YTD Actual	Balance	Per. Of Bud
Salaries	175,475	14,301	13,560	13,960	13,761	14,458	14,957	15,852	16,350	13,038	13,780	13,235	17,631	174,883	592	100%
Overtime	12,500	473	424	802	183	319	1,070	476	164	168	71	114	487	4,750	7,750	38%
FICA/Medicare Taxes	12,669	1,130	1,070	1,119	1,048	1,113	1,207	1,231	1,244	995	1,044	1,005	1,362	13,568	(899)	107%
T.W.C. Payroll Taxes	876	0	0	8	14	47	474	206	44	42	24	7	0	865	11	99%
Health Insurance Premiums	35,040	2,595	2,595	2,595	2,595	2,595	2,595	2,595	2,595	2,595	2,595	2,595	2,595	31,135	3,905	89%
Workers Compensation	560	12	12	12	12	12	12	12	12	12	12	12	12	144	416	26%
Deferred Compensation	3,400	266	257	266	266	249	266	257	266	257	266	231	291	3,137	263	92%
Life Insurance	386	36	29	29	29	13	29	29	29	29	29	13	29	321	65	83%
Dental Insurance Expense	1,168	92	92	92	92	92	92	92	92	83	83	166	0	1,072	96	92%
Vision Insurance Expense	252	18	18	18	18	17	18	18	18	18	18	17	18	216	36	86%
Total Personnel	242,326	18,924	18,056	18,900	18,017	18,914	20,721	20,768	20,814	17,236	17,921	17,395	22,425	230,092	12,234	95%
Office Expense and Supplies	9,000	857	471	282	716	2,459	3,039	188	(231)	263	(636)	(160)	157	7,405	1,595	82%
Uniforms	1,000	0	0	0	337	0	38	0	0	0	0	0	0	375	625	37%
Building & Property Maint	7,000	523	192	189	230	750	190	102	304	1,384	(628)	52	2,430	5,719	1,281	82%
Utilities	7,000	1,190	645	2,580	820	(1,281)	446	292	278	332	293	305	863	6,762	238	97%
Telephone	38,000	2,192	2,192	2,241	294	4,260	2,366	2,366	5,126	2,552	2,550	2,560	2,477	31,176	6,824	82%
Legal Fees	2,000	0	198	0	0	0	0	0	0	0	0	0	0	198	1,802	10%
Property Insurance	6,000	439	439	439	439	439	439	439	439	439	439	439	439	5,268	732	88%
Advertising/Drug Testing	11,000	0	3,482	1,969	0	0	0	0	0	0	0	0	0	5,451	5,549	50%
Dues/Subscriptions	2,000	0	0	0	0	91	0	419	0	0	1,190	2,886	(768)	3,819	(1,819)	191%
Liability Insurance	3,600	225	225	225	225	225	225	225	225	225	225	225	225	2,700	900	75%
Service Contracts	17,000	2,504	1,840	2,504	1,287	222	302	291	243	1,895	168	421	289	11,966	5,034	70%
Support Activities	9,000	989	1,589	1,158	677	460	90	99	833	10	(699)	41	125	5,369	3,631	60%
Events	35,300	5,350	347	4,991	626	16,832	3,694	0	(354)	0	1,040	0	0	32,526	2,774	92%
Equipment Rental/Lease	7,300	271	271	3,676	271	271	395	135	135	559	135	135	386	6,639	661	91%
Seminars/Training	500	35	0	1	0	0	0	0	0	28	0	0	0	64	436	13%
Vehicle Repair & Maintenance	2,000	259	15	195	253	29	0	0	48	0	0	55	0	855	1,145	43%

City of Socorro
 Unaudited Budget Vs Expenditures
 General Fund
 For October 1, 2019 through September 30, 2020

<i>Expenditures-Recreational Centers</i>															Budgeted	
Account Title	Budget	Oct-19	Nov-19	Dec-19	Jan-20	Feb-20	Mar-20	Apr-20	May-20	June-20	July-20	Aug-20	Sept-20	YTD Actual	Balance	Per. Of Bud
Equipment Repair & Maint	1,600	170	0	0	0	0	0	0	0	10	0	51	0	231	1,369	14%
Vehicle Fuel	3,000	240	240	129	151	163	113	16	20	60	32	170	33	1,366	1,634	46%
Travel/Mileage/Per Diem	2,000	0	0	0	6	0	0	0	0	0	0	0	0	6	1,994	0%
Property and Equipment	15,000	0	1,241	6,293	2,701	48	220	1,211	172	153	(903)	2	0	11,138	3,862	74%
Total Operating	179,300	15,241	13,388	26,871	9,032	24,967	11,557	5,783	7,238	7,911	3,207	7,183	6,655	139,033	40,267	78%
Total Expenses	421,626	34,165	31,444	45,772	27,049	43,881	32,277	26,552	28,052	25,147	21,129	24,577	29,079	369,125	52,501	88%

<i>Expenditures-Fire Ambulance</i>															Budgeted	
Account Code	Budget	Oct-19	Nov-19	Dec-19	Jan-20	Feb-20	Mar-20	Apr-20	May-20	June-20	July-20	Aug-20	Sept-20	YTD Actual	Balance	Per. Of Bud
		0	0	0	0	0	0	0	0	0	0	0	0		-	0%
Total Personnel		0	0	0	0	0	0	0	0	0	0	0	0	0	0	0%
Utilities	130	0	0	0	0	0	0	129	0	0	0	0	0	129	1	100%
Ambulance Contract	140,000	0	0	0	27,500	0	0	27,500	0	0	0	0	55,000	110,000	30,000	79%
Service Contracts	5,385					5,385	0	0	0	0	0	0	0	5,385	-	100%
Vehicle Fuel	12,000	909	900	837	790	626	790	369	574	595	909.39	653.42	716.46	8,670	3,330	72%
Total Operating	157,515	909	900	837	28,290	6,011	790	27,999	574	595	909	653	55,716	124,185	30,000	79%

City of Socorro
 Unaudited Budget Vs Expenditures
 General Fund
 For October 1, 2019 through September 30, 2020

Total Expenses	157,515	909	900	837	28,290	6,011	790	27,999	574	595	909	653	55,716	124,185	30,000	79%
Account Title	Budget	Oct-19	Nov-19	Dec-19	Jan-20	Feb-20	Mar-20	Apr-20	May -20	June -20	July -20	Aug -20	Sept -20	YTD Actual	Balance	Per. Of Bud
Salaries	52,510	4,422	4,288	4,430	4,430	4,145	4,430	4,659	4,749	4,287	4,430	3,858	4,659	52,788	(278)	101%
FICA/Medicare Taxes	4,017	338	328	316	298	278	298	316	322	288	298	260	312	3,653	364	91%
T.W.C. Payroll Taxes	146	0	0	2	4	2	99	37	0	0	0	0	0	144	2	99%
Health Insurance Premiums	8,760	679	679	679	679	496	679	679	679	679	679	496	679	7,784	976	89%
Workers Compensation	145	6	6	6	6	6	6	6	6	6	6	6	6	72	73	50%
Deferred Compensation	1,500	0	0	0	0	0	0	0	0	0	0	0	0	0	1,500	0%
Life Insurance	137	9	9	9	9	9	9	9	9	9	9	9	9	111	26	81%
Dental Insurance Expense	292	26	26	26	26	9	26	26	26	20	23	62	(30)	265	27	91%
Vision Insurance Expense	63	5	5	5	5	3	5	5	5	5	5	3	5	54	9	86%
Total Personnel	67,570	5,485	5,341	5,474	5,458	4,948	5,552	5,737	5,796	5,295	5,451	4,694	5,640	64,871	2,699	96%
Office Expense and Supplies	4,000	775	1,602	238	0	0	20	1,103	172	0	0	0	0	3,910	90	98%
Tools and Supplies	2,500	462	170	535	612	486	0	47	53	0	0	60	0	2,426	74	97%
Uniforms	1,000	0	218	168	0	0	0	0	0	0	0	190	67	642	358	64%
Service Contracts	72,000	6,949	1,735	4,005	2,094	5,965	907	349	349	3,537	349	2,793	(138)	28,893	43,107	40%
Seminars/Training	0	0	0	0	(10)	0	0	0	0	0	0	0	0	(10)	10	#DIV/0!

<i>Expenditures-Information Technology</i>																
Account Title	Budget	Oct-19	Nov-19	Dec-19	Jan-20	Feb-20	Mar-20	Apr-20	May -20	June -20	July -20	Aug -20	Sept -20	YTD Actual	Budgeted Balance	Per. Of Bud
Equipment Repair & Maint	4,200	0	0	0	309	2,369	35	579	0	0	155	0	10	3,457	743	82%
Vehicle Repair & Maintenance	100	0	0	0	0	0	0	15	0	0	0	0	0	15	85	15%
Vehicle Fuel	150	0	0	0	0	0	0	25	0	0	47	83	0	155	(5)	103%
Travel/Mileage/Per Diem	2,500	0	0	839	329	0	0	0	0	0	0	0	0	1,168	1,332	47%
Property & Equipment	63,000	0	0	1,162	4,537	8,054	4,238	0	150	13,832	170	263	72	32,476	30,524	
Total Operating	149,450	8,187	3,724	6,946	7,872	16,874	5,199	2,117	725	17,369	721	3,388	11	73,133	45,793	49%
Total Expenses	217,020	13,672	9,065	12,420	13,329	21,822	10,751	7,855	6,521	22,664	6,172	8,082	5,651	138,004	48,492	64%

Total Personnel-All Departments	6,418,133	513,172	510,416	521,885	518,538	474,476	508,319	521,703	554,359	500,593	520,491	452,925	577,967	6,174,842	243,291	96%
Total Operating-All Departments	3,945,854	209,984	212,724	229,987	208,658	399,339	387,873	361,815	205,830	296,219	108,880	291,719	322,326	3,235,355	710,498	82%
Total Expenditures-All Departments	10,363,987	723,156	723,141	751,872	727,196	873,815	896,191	883,518	760,189	796,811	629,371	744,644	900,293	9,410,197	953,789	91%

City of Socorro
 Capital Projects Funds Unaudited Trial Balances
 As of 9/30/2020

400 - CAPITAL PROJECTS 2019 CO's

<u>Account Code</u>	<u>Account Title</u>	<u>Debit Balance</u>	<u>Credit Balance</u>
01048	Wells Fargo- Capital Projects	896,578.49	
01054	Logic Investments - Capital	6,069,251.03	
01251	Inter-Fund Receivable		1,724.56
01800	Bond Issuance Costs	25,169.00	
02000	Accounts Payable Clearing Acct	0.18	
02004	Accounts Payable		5,159.00
03100	Fund Balance-Restricted		8,801,330.07

401 - CAPITAL PROJECTS-14 CO

<u>Account Code</u>	<u>Account Title</u>	<u>Debit Balance</u>	<u>Credit Balance</u>
01050	Cash-2014 CO	386,773.20	
01251	Inter-Fund Receivable	33,754.41	
01371	Park Improvements	0.44	
02000	Accounts Payable Clearing Acct		216.00
02200	Inter-Fund Payable		457.00
03100	Fund Balance-Restricted	<u>0.00</u>	<u>429,465.40</u>

Report Total	<u>7,411,526.75</u>	<u>9,238,352.03</u>
--------------	---------------------	---------------------

Report Difference		<u>1,826,825.28</u>
-------------------	--	---------------------

City of Socorro
 Cares Act Fund Unaudited Trial Balance
 As of 9/30/2020

101 - CARES ACT FUND

<u>Account Code</u>	<u>Account Title</u>	<u>Debit Balance</u>	<u>Credit Balance</u>
01055	CARES ACT FUNDS	242,916.86	
01251	Inter-Fund Receivable		2,497.57
02004	Accounts Payable		62,189.00
04704	Other Revenue		378,070.00
05201	Office Expense and Supplies	9,811.28	
05202	Medical Supplies	126.84	
05212	Tools and Supplies	799.37	
05213	Uniforms	177.48	
05311	Building & Property Maintenan	83,307.80	
05314	Telephone	829.09	
05516	Dues/Subscriptions	581.71	
05520	Service Contracts	495.00	
05521	Support Activities	771.39	
05613	Equipment Repair & Maintenance	4.82	
05810	Property and Equipment	3,714.42	
05900	Emergency Aid and Assistance	49,471.51	
07502	Building and Facilities	49,749.00	0.00
		<u>442,756.57</u>	<u>442,756.57</u>
Report Total		<u>442,756.57</u>	<u>442,756.57</u>
Report Difference		-	

City of Socorro
Debt Service Fund Unaudited Trial Balance
As of 9/30/2020

200 - DEBT SERVICE FUND

<u>Account Code</u>	<u>Account Title</u>	<u>Debit Balance</u>	<u>Credit Balance</u>
01001	Wells Fargo- Debt Service	475,249.99	
01200	Property Taxes Receivable	536,607.09	
01205	Allowance		355,334.71
02200	Inter-Fund Payable		15,975.03
03100	Fund Balance-Restricted	<u>0.00</u>	<u>445,637.42</u>
Report Total		<u><u>1,011,857.08</u></u>	<u><u>816,947.16</u></u>
Report Difference		<u><u>194,909.92</u></u>	

City of Socorro
 Historical and Fund Balance Projections:
 Unrestricted Fund Balance Analysis

Fiscal Year End	2015	2016	2017	2018	2019	2020
Beginning Fund Balance	\$ 4,167,688	\$ 4,112,045	\$ 4,879,435	\$ 5,127,897	\$ 4,851,812	\$ 5,206,480
Fund Balance Adjustment per 2016 Audit		15,945				
Net Change in Fund Balance (Revenues-Expenditures)	<u>(55,643)</u>	<u>751,445</u>	<u>248,462</u>	<u>(276,085)</u>	<u>354,668</u>	<u>1,097,835</u>
Ending Fund Balance	<u>\$ 4,112,045</u>	<u>\$ 4,879,435</u>	<u>\$ 5,127,897</u>	<u>\$ 4,851,812</u>	<u>\$ 5,206,480</u>	<u>\$ 6,304,315</u>

Total General Fund - Fund Balance	\$ 6,304,315
Commitments and Adjustments:	
Current Year's Net Change in Fund Balance (Revenues in Excess of Expenditures)	-
Minimum Fund Balance - 2 months worth or 16.67% of Budgeted Expenditures of \$9,534,443	(1,589,392)
Current Year Budgeted Expenses in Excess of Revenues	-
Arterial Project	(239,752)
Safe Routes to Schools	<u>(245,452)</u>
Unrestricted General Fund - Fund Balance	<u>\$ 4,229,719</u>

City of Socorro
 General Fixed Assets Unaudited Trial Balance
 As of 9/30/2020

300 - GENERAL FIXED ASSETS

<u>Account Code</u>	<u>Account Title</u>	<u>Debit Balance</u>	<u>Credit Balance</u>
01300	Security Deposits	5,000.00	
01311	Machinery & Equipment	2,386,556.00	
01312	Vehicles	1,806,794.00	
01320	Buildings and Improvements	596,812.64	
01321	Buildings and Improvements	1,701,981.36	
01331	Office Furniture and Fixtures	346,358.00	
01341	Land	2,820,493.00	
01345	Software	87,241.00	
01352	Work in Progress	2,975,473.63	
01353	Infrastructure	43,878,119.76	
01366	Leasehold Improvements	212,942.05	
01511	Accum. Dep - Machinery & Equip		1,890,307.29
01512	Accum. Dep - Vehicles		1,162,351.24
01521	Accum. Dep - Buildings		839,414.88
01531	Accum. Dep - Office Furniture		327,904.75
01545	Accum. Dep - Software		78,653.31
01553	Accum. Dep - Infrastructure		10,090,309.36
01566	Accum. Dep - Leasehold Improve.		114,647.84
03100	Fund Balance-Restricted	11,684,478.24	
03250	Investment in Fixed Assets	<u>0.00</u>	<u>53,998,661.01</u>
Report Total		<u><u>68,502,249.68</u></u>	<u><u>68,502,249.68</u></u>
Report Difference		-	

City of Socorro
 General Long Term Debt
 As of 9/30/2020

500 - GENERAL LONG TERM DEBT

<u>Account Code</u>	<u>Account Title</u>	<u>Debit Balance</u>	<u>Credit Balance</u>
01211	Bond Defeasance Costs	107,574.00	
01400	Amounts to be Provided	19,843,890.19	
02230	Certificate of Obligation-2011		1,855,000.00
02232	Certificate of Obligation 2014		7,715,000.00
02233	GENERAL OBLIGATION REF BONDS		2,840,000.00
02234	Certificate of Obligation 2019		9,495,000.00
02235	Refunding Bond - 2020		6,225,000.00
02800	Accrued Interest Payable		77,215.00
02900	Bond Premium		2,190,370.03
03100	Fund Balance-Restricted	<u>10,314,093.49</u>	<u>0.00</u>
Report Total		<u>30,265,557.68</u>	<u>30,397,585.03</u>
Report Difference			<u><u>132,027.35</u></u>

City of Socorro
 General Fund Unaudited Trial Balance
 As of 9/30/2020

001 - GENERAL FUND

Account Code	Account Title	Debit Balance	Credit Balance
01010	Wells Fargo-M&O	1,179,844.59	
01016	Petty Cash Fund	1,150.00	
01039	Logic-Investments	3,778,427.42	
01100	Accounts Receivable	102.12	
01200	Property Taxes Receivable	1,683,052.17	
01201	Sales Taxes Receivable	249,190.24	
01202	Franchise Fees Receivable	176,403.36	
01203	Muni.Court Warrants Receivable	6,401,727.85	
01205	Allowance		1,114,496.77
01206	Gas Inventory	7,372.46	
01209	Prepaid Expenses	6,245.76	
01220	Allowance for Uncoll. Warrants		6,213,995.38
01248	Accounts Receivable	1.00	
01250	Due From Grantor		116,162.74
01251	Inter-Fund Receivable	793,694.07	
02000	Accounts Payable Clearing Acct	8,142.98	
02001	Accounts Payable	110.00	
02004	Accounts Payable		291,807.43
02005	AFLAC Sup Ins. Withheld (Emp)		1,620.12
02051	T.W.C. Payable		1,062.61
02101	Child Support		2,698.98
02122	Accrued Vacation		0.36
02126	Child Safety Seat/Belt Fines		789.50
02200	Inter-Fund Payable		181,149.44
02596	Bankruptcy Withheld		117.85
02597	Socorro Police Officers Assoc.		15.72
02598	Life Insurance Prem Withheld		972.97
02599	Dental Premiums Withheld		1,926.04
02602	Deferred Compensation Withheld		4,356.59
02603	Insurance Premiums Withheld		11,574.87
02604	Cleat Dues		141.44
02608	Local 59-AFL-CIO		93.52
02609	Accrued Salaries		113,975.35
02610	FICA Taxes Withheld/Payable		22,243.69
02611	Federal Income Taxes Withheld		11,320.24
02614	Vision Payable (EmplDeduction)		268.75
02615	HSA Health Savings		158.92
02616	Bond Deposits		441.95
02617	Collection Agency COLL	0.20	
02620	Deferred Compensation Payable		3,863.55
02623	EP FITNESS Withholding		740.38
03000	Fund Balance Int. Capital Projects	105,956.29	
03000	Fund Balance Hotel Tax Adj. Spec Rev	8,738.00	
03000	Fund Balance-Unrestricted		4,721,124.76
03300	Comm. Fund Balance Arterial		239,751.78
03301	Committed Fund Balance SRS	0.00	245,452.00
Report Total		<u>14,400,158.51</u>	<u>13,302,323.70</u>
Report Difference		<u>1,097,834.81</u>	

ITEM 10

Elia Garcia
Mayor

Rene Rodriguez
Representative
At Large

Cesar Nevarez
District 1
Mayor Pro-Tem



Ralph Duran
District 2

Victor Perez
District 3

Yvonne Colon-Villalobos
District 4

Adriana Rodarte
City Manager

DATE: November 5, 2020
TO: MAYOR AND CITY COUNCIL
FROM: Job Terrazas, Building Official
CC: Adriana Rodarte, City Manager

SUBJECT:

Consider and Take Action on the proposed amendment to several sections of the Municode to allow the setbacks required for accessory structures to be reduced to five feet.

SUMMARY:

There are several sections in the City of Socorro's Municode that require a 10' feet separation from the rear property line for accessory buildings.

BACKGROUND:

Historically, there have been several plan submittals that have been received at the Planning & Zoning Department asking for a 5' foot separation from the rear property line for an accessory building.

STATEMENT OF THE ISSUE:

The plan submittals that have been received at the Planning & Zoning Department have been denied, put on hold or have been presented to the Board of Adjustments to reduce the rear setbacks. The provisions that are proposed to be amended are not for the public interest and create a burden on properties that have a small back yard.

STAFF RECOMMENDATION:

The Planning and Zoning Department recommends APPROVAL to allow the rear setbacks to be reduced to five feet to allow accessory buildings and regulate the separation of structures for fire protection.

BOARD RECOMMENDATION:

The Planning and Zoning Commission recommends APPROVAL with the condition that at least 5 accessory buildings are allowed per lot.

Amended Accessory Structures/Buildings Requirements

DIVISION 3. - R-1 - SINGLE-FAMILY RESIDENTIAL DISTRICT

Sec. 46-239. - Accessory structures.

- (a) No accessory structure, excluding fences, ~~patios, porches~~ or walls, shall be closer to any property line than the required yard setback; however, an accessory structure may be as close as ~~ten~~ five feet to any ~~rear~~ property line.
- (b) An accessory structure shall not exceed 50 percent of the ~~the interior~~ square footage of the principal structure.

DIVISION 4. - R-2 - MEDIUM DENSITY RESIDENTIAL DISTRICT

Sec. 46-263. - Accessory structures.

- (a) No accessory structure, excluding fences, ~~patios, porches~~ or walls, shall be closer to any property line than the required yard setback; however, an accessory structure may be as close as ~~ten~~ five feet to any ~~rear~~ property line.
- (b) An accessory structure shall not exceed 50 percent of the ~~interior~~ square footage of the principal structure.

DIVISION 5. - R-3 - HIGH DENSITY RESIDENTIAL DISTRICT (not in Municode)

DIVISION 6. - *RM-1* - MOBILE HOME SUBDIVISION DISTRICT

Sec. 46-329. - Accessory structures.

- (a) No accessory structure, excluding fences, ~~patios, porches~~ or walls, shall be closer to any property line than the required yard setback; however, an accessory structure may be as close as ~~ten~~ five feet to any ~~rear~~ property line.
- (b) An accessory structure shall not exceed 50 percent of the square footage of the principal building.

DIVISION 7. - *RM-2* - RESIDENTIAL MOBILE HOME PARK DISTRICT

Sec. 46-352. - Accessory structures.

- (a) No accessory structure, excluding fences, ~~patios, porches~~ or walls, shall be closer than ~~three~~ five feet.
- (b) An accessory structure shall not exceed 50 percent of the square footage of the principal building.

Sec. 46-623. - Accessory building.

All accessory buildings must comply with the street right-of-way and side lot boundary setbacks, but (subject to the remaining provisions of this chapter) shall be required to observe a ~~ten~~ five-foot setback from ~~rear~~-lot boundary lines.

- (a) No more than one accessory building intended to be used as storage shall be allowed per lot.
- (b) An accessory storage shall not be allowed until 50 percent of the principal structure has been erected.
- (c) Shipping containers shall not be used as accessory buildings in residential zones. These accessories shall only be allowed as temporary storage during the construction of the principal structure.
- (d) Accessory buildings shall only be allowed in the rear or side of the principal structure.

Elia Garcia
Mayor
Rene Rodriguez
At Large
Mayor Pro Tem
Maria Reyes
District 1



Ralph Duran
District 2
Victor Perez
District 3
Yvonne Colon-Villalobos
District 4
Adriana Rodarte
City Manager

ORDINANCE _____

AN ORDINANCE TO AMEND CHAPTER 46 (ZONING), SECTIONS 46-239 (ACCESSORY STRUCTURES), 46-263 (ACCESSORY STRUCTURES), 46-329 (ACCESSORY STRUCTURES), 46-352 (ACCESSORY STRUCTURES), and 46-623 (ACCESSORY BUILDING) TO REDUCE REAR SETBACK REQUIREMENTS FOR ACCESSORY STRUCTURES.

WHEREAS, the City of Socorro desires to and believes its in the best interests of the City to amend rear set back requirements for accessory structures in the City of Socorro, Texas;

NOW, THEREFORE, BE IT ORDAINED BY THE CITY COUNCIL OF THE CITY OF SOCORRO, TEXAS:

(Deletions of current text are noted in red strike through font and additions are noted in blue underline font)

Section 2. That Chapter 46 (Zoning), be revised as follows:

DIVISION 3. - R-1 - SINGLE-FAMILY RESIDENTIAL DISTRICT

Sec. 46-239. - Accessory structures.

- (a) No accessory structure, excluding fences, ~~patios, porches~~ or walls, shall be closer to any property line than the required yard setback; however, an accessory structure may be as close as ~~ten~~ five feet to any ~~rear~~ property line.
- (b) An accessory structure shall not exceed 50 percent of the ~~the interior~~ square footage of the principal structure.

DIVISION 4. - R-2 - MEDIUM DENSITY RESIDENTIAL DISTRICT

Sec. 46-263. - Accessory structures.

- (a) No accessory structure, excluding fences, ~~patios, porches~~ or walls, shall be closer to any property line than the required yard setback; however, an accessory structure may be as close as ~~ten~~ five feet to any ~~rear~~ property line.
- (b) An accessory structure shall not exceed 50 percent of the ~~interior~~ square footage of the principal structure.

DIVISION 6. - RM-1 - MOBILE HOME SUBDIVISION DISTRICT

Sec. 46-329. - Accessory structures.

- (a) No accessory structure, excluding fences, ~~patios, porches~~ or walls, shall be closer to any property line than the required yard setback; however, an accessory structure may be as close as ~~ten~~ five feet to any ~~rear~~ property line.
- (b) An accessory structure shall not exceed 50 percent of the square footage of the principal building.

DIVISION 7. - RM-2 - RESIDENTIAL MOBILE HOME PARK DISTRICT

Sec. 46-352. - Accessory structures.

- (a) No accessory structure, excluding fences, ~~patios, porches~~ or walls, shall be closer than ~~three~~ five feet.
- (b) An accessory structure shall not exceed 50 percent of the square footage of the principal building.

Sec. 46-623. - Accessory building.

All accessory buildings must comply with the street right-of-way and side lot boundary setbacks, but (subject to the remaining provisions of this chapter) shall be required to observe a ~~ten~~ five-foot setback from ~~rear~~-lot boundary lines.

- (a) No more than one accessory building intended to be used as storage shall be allowed per lot, unless the property is more than one acre, then the property may have up to two accessory buildings for storage (but no more than 5 accessory buildings total, including 2 accessory buildings for storage).
- (b) An accessory storage shall not be allowed until 50 percent of the principal structure has been erected.
- (c) Shipping containers shall not be used as accessory buildings in residential zones. These accessories shall only be allowed as temporary storage during the construction of the principal structure.
- (d) Accessory buildings shall only be allowed in the rear or side of the principal structure.

Section 3. Except as expressly herein amended, Chapter 46 (Zoning) of the Code of Ordinances of the City of Socorro, Texas, shall remain in full force and effect.

Section 4. Savings/Repealing Clause.

This Ordinance shall be cumulative of all other Ordinances and shall not repeal any of the provisions of such Ordinances except for those instances where there are direct conflicts with the provisions of this Ordinance. Ordinances or parts thereof in force at the time this Ordinance shall take effect and that are inconsistent with this Ordinance are hereby repealed to the extent that they are inconsistent with this Ordinance. Provided however, that any complaint, action, claim or lawsuit which has been initiated or has arisen under or pursuant to such Ordinance on the date of adoption of this Ordinance shall

continue to be governed by the provisions of that Ordinance and for that purpose the Ordinance shall remain in full force and effect.

Section 5. Severability Clause.

Should any section, subsection, sentence, clause or phrase of this Ordinance be declared unconstitutional or invalid by a court of competent jurisdiction, it is expressly provided that any and all remaining portions of this Ordinance shall remain in full force and effect. The City of Socorro hereby declares that it would have passed this Ordinance, and each section, subsection, sentence, clause or phrase thereof irrespective of the fact that any one or more sections, subsections, sentences clauses and phrases be declared unconstitutional or invalid.

Section 3. Publication/Effective Date.

This ordinance shall take effect immediately from and after is passage and publication of the caption, as required by law.

READ, APPROVED AND ADOPTED this _____ day of _____ 2020.

CITY OF SOCORRO, TEXAS

Elia Garcia, Mayor

ATTEST:

Olivia Navarro, City Clerk

APPROVED AS TO FORM:

APPROVED AS TO CONTENT:

James A. Martinez
Socorro City Attorney

Adriana Rodarte, City Manager

Introduction and First Reading: _____, 2020
Second Reading and Adoption: _____, 2020

Elia Garcia
Mayor
Rene Rodriguez
At Large
Cesar Nevarez
District 1 / Mayor Pro-Tem



Ralph Duran
District 2
Victor Perez
District 3
Yvonne Colon-Villalobos
District 4
Adriana Rodarte
City Manager

October 30, 2020

TO: MAYOR AND CITY COUNCIL MEMBERS

FROM: Alejandra Valadez, Grants Coordinator

SUBJECT:

Discussion and action to approve the submission of a grant application to the Texas Historical Commission's FY 2021 Certified Local Government Program to offset the costs of an interactive website and virtual map/tour of the Rio Vista Farm Historic District to educate the public about the complex history of the site and increase accessibility to the site. There is a match requirement of 1:1.

SUMMARY

The City of Socorro will submit a grant application to the Texas Historical Commission's FY 2021 Certified Local Government Program requesting funding for an interactive website and virtual map/tour of the Rio Vista Farm Historic District to educate the public about the complex history of the site and increase accessibility to the site. The match requirement for this grant is a ratio of 1:1.

STATEMENT OF THE ISSUE

The current pandemic has limited access to our local historical sites. An interactive website and virtual map/tour of the Rio Vista Farm Historic District is needed to educate the public about the complex history of the site and increase accessibility to the site even during the current pandemic.

FINANCIAL IMPACT

Account Code (GF/GL/Dept): General Fund

Funding Source: N/A

Amount: Up to \$10,000 matching funds

Quotes (Name/Commodity/Price): N/A

Co-op Agreement (Name/Contract#): N/A

ALTERNATIVE

Not approve – The City will **not** submit a grant application to the Texas Historical Commission’s FY 2021 Certified Local Government Program.

STAFF RECOMMENDATION

Approve - The City **will** submit a grant application to the Texas Historical Commission’s FY 2021 Certified Local Government Program and commit to the required match.

REQUIRED AUTHORIZATION

1. City Manager _____ Date _____
2. CFO _____ Date _____
3. Attorney _____ Date _____

RE: FY21 CLG Letter of Intent - City of Socorro, TexasFrom: [Maria Mougridis <Maria.Mougridis@thc.texas.gov>](mailto:Maria.Mougridis@thc.texas.gov)

Sent: Thu, Oct 8, 2020 at 8:30 am

To: Alejandra Valadez

Cc: Victor Reta, Rodrigo Molina

[image001.png](#) (5.8 KB)[image002.png](#) (1.8 KB)[image003.png](#) (< 1 KB)[image004.png](#) (< 1 KB)[image005.png](#) (< 1 KB)[image006.png](#) (< 1 KB)[image007.png](#) (< 1 KB)[image008.png](#) (< 1 KB)[– Download all](#)

Alejandra,

After reviewing the submitted LOI, we suggest to either pursue the survey/inventory project or the education/outreach project.

Maria Mougridis

From: Maria Mougridis <Maria.Mougridis@thc.texas.gov>**Sent:** Wednesday, September 30, 2020 4:10 PM**To:** Alejandra Valadez <grants@ci.socorro.tx.us>**Cc:** Victor Reta <vreta@ci.socorro.tx.us>; Rodrigo Molina <grantstech@ci.socorro.tx.us>**Subject:** RE: FY21 CLG Letter of Intent - City of Socorro, Texas

Thank you Alejandra. I'll take a look at your LOI and get back to you with any comments.

Maria Mougridis

Certified Local Government Specialist
Community Heritage Development Division
P.O. Box 12276, Austin, Texas 78711-2276
Phone: +1 512 463 9063

From: Alejandra Valadez <grants@ci.socorro.tx.us>**Sent:** Wednesday, September 30, 2020 4:02 PM**To:** Maria Mougridis <Maria.Mougridis@thc.texas.gov>**Cc:** Victor Reta <vreta@ci.socorro.tx.us>; Rodrigo Molina <grantstech@ci.socorro.tx.us>**Subject:** FY21 CLG Letter of Intent - City of Socorro, Texas

CAUTION: External Email – This email originated from outside the THC email system. Do not click links or open attachments unless you recognize the sender and know the content is safe.

Good afternoon Ms. Mougridis,

I hope this email finds you well. Please see the Letter of Intent attached from the City of Socorro, Texas. Should you have any questions, please feel free to contact us at any time.

Attentively,

Alejandra Valadez

10/29/2020

RE: FY21 CLG Letter of Intent - City of Socorro, Texas

Grants Coordinator

City of Socorro, Texas

Office 915-858-2915 Ext. 5015

Cell 915-209-9312

grants@ci.socorro.tx.us

The Census is HERE!

Each year, the Federal government distributes

Over \$800 billion dollars to communities like Socorro

and El Paso. Without an accurate census count,

our communities could lose out!

Get Counted TODAY!

<https://my2020census.gov/>

INTRODUCTION

Certified Local Government (CLG) grants provide funding to participating city and county governments to develop and sustain an effective local preservation program critical to preserving local historic resources. The Texas Historical Commission (THC), the state agency for historic preservation, administers the Texas CLG grant program utilizing federal funding it receives from the U.S. Department of Interior, National Park Service (NPS) Historic Preservation Fund Program. Under this program the NPS requires that at least ten percent (10%) of Texas' annual federal allocation be subgranted exclusively to participating Certified Local Governments (CLGs). The program serves as a great resource for participating county and city governments to offset the costs of self-sustaining preservation and planning-related projects. Currently, there are 76 CLGs in Texas. Contingent on resolution of the federal budget, we anticipate approximately \$90,000 to \$120,000 will be available for this round of grants.

ADMINISTRATIVE INFORMATION

- Administration** Grants will be administered in accordance with the National Park Service Historic Preservation Fund Grants Manual, June 2007; Texas Administrative Code Title 13, Part 2, Chapter 15.6, *Rules and Procedures for Certified Local Governments*; and this manual.
- Grant Period** The grant period is October 1, 2020 to September 30, 2022. Project preparation, including drafting any applicable RFPs, may begin before your grant request is awarded and a grant contract signed, **however, costs incurred prior to the execution of a signed contract with the THC are not eligible for reimbursement.** Despite the official grant period beginning October 1st, grants will be awarded in 2021 following funding notification from the National Park Service.
- Application Package** **The grant application form is included in this manual.** A complete application submittal package consists of 1 unbound hard copy and 1 digital copy of the following documents:
- Application Form (with original signatures)
 - Budget Worksheet (template is attached to the application form)
 - Resume of Project Manager (City or County staff, and/or representative of the third-party organization)
 - Resumes of all outside consultants, contractors, and/or individuals responsible for project oversight
 - Persons supervising grant projects must meet the Secretary of the Interior's Professional Qualification Standards
 - If the applicant is planning to hire a consultant or subcontractor, resumes may be submitted following the selection process
 - Any applicable cost estimates, maps, drawings, or photographs
 - **Determination of Eligibility Statement**
 - Required for all National Register nomination grant requests
 - Required for all Construction/Development grant requests for properties not already listed on the National Register
 - Recommended for all Survey/Inventory projects

Visit <http://www.thc.texas.gov/preserve/projects-and-programs/national-register-historic-places/request-determination-eligibility> for instructions on how to request a Determination of Eligibility Statement.

Submittal Deadline A complete grant application package (hard copy and electronic) must be received **no later than 5 p.m. Monday, November 2, 2020.**

One electronic copy of the application must be submitted via e-mail **and** one printed copy must be delivered to:

HAND DELIVER OR COURIER SERVICE

Texas Historical Commission
Community Heritage Development Division
ATTN: Maria Mougridis, CLG Program Specialist
1304 Colorado Street
Austin, Texas 78701

U.S. MAIL

Texas Historical Commission
Community Heritage Development Division
ATTN: Maria Mougridis, CLG Program Specialist
PO Box 12276
Austin, Texas 78711-2276

WHO MAY APPLY

Only city or county governments, and state recognized Native American Tribes that have been individually "certified" by the National Park Service **before** November 2, 2020 are eligible to apply for CLG grants. **The THC reserves the right to disqualify applications from CLG communities that are not in compliance with the CLG Certification Agreement.**

In an attempt to distribute CLG grant funds to as many CLGs as possible, preference will be given to applicants that have not received or directly benefited from CLG grant funds in the past five years.

A CLG may submit more than one grant application; however, a separate application package must be submitted for each project request.

The following entities may also be eligible:

- An organization such as a non-CLG city or another unit of local government, a commercial firm, a non-profit entity or educational institution that has administrative capabilities that comply with applicable federal standards and has been delegated as a third-party to administer the grant on behalf of the CLG. The contributed services of the third party to the CLG may be counted toward the matching share requirements of the grant. The third party may apply for the CLG grant directly, in which case, the Historic Preservation Officer or CLG Representative and the Chief Elected Official must sign the application.

ELIGIBLE PROJECTS

Activities eligible for CLG grant funding must be tied to the statewide comprehensive preservation planning process. A copy of the THC's Statewide Preservation Plan can be found at: <http://www.thc.texas.gov/preserve/projects-and-programs/texas-statewide-preservation-plan> as well as in the grant application. In an effort to encourage local governments to develop and sustain an effective local preservation program critical to preserving local historic resources, **priority for funding shall be given to those projects that directly relate to the following work categories:**

- Architectural, historical, archeological surveys/inventories
- Preparation of nominations to the National Register of Historic Places
- Preparation of a local preservation plan
- Writing or amending a preservation ordinance

- Development of local design guidelines
- Research and development of a local preservation incentive program

The above list should not dissuade an applicant from applying for assistance towards other eligible projects such as:

- Development of educational publications and activities, slide shows, videos, websites, etc.
- Development of publication of walking/driving tours
- Development of architectural drawings and specifications
- Preparation of facade studies or condition assessments
- Rehabilitation or restoration of properties individually listed in the National Register of Historic Places or contributing to a National Register historic district
- Training expenses for individual commission members and staff

SPECIAL CONSIDERATION FOR UNDERREPRESENTED COMMUNITIES

The CLG program is committed to enhancing untold stories, and engaging and including a wider range of communities, perspectives, and voices in our state’s and nation’s historical narrative. To further this goal, we encourage projects from or related to communities currently underrepresented, including but not limited to Black Americans, Hispanic Americans, Asian Americans, Native Americans, Women, and LGBTQ Americans. Projects can include but are not limited to oral history projects, National Register nominations, historic resources surveys, diversity and inclusion trainings, and projects with an emphasis on cultural heritage or broader themes such as the Civil Rights movement, women’s history, and immigrant history.

Projects will be considered as part of the regular CLG grant cycle. Please reach out to program staff if you have any questions about deadlines, match requirements or project type.

PROFESSIONAL QUALIFICATIONS STANDARDS

To ensure that appropriate historical, architectural, archeological and cultural properties are identified for public benefit through grant-in-aid assistance, persons supervising grant projects must be professionally qualified in accordance with 36CFR61. The Professional Qualification Standards can be found here:

https://www.nps.gov/history/local-law/arch_stnds_9.htm

SECTION 106

CLG Grants are funded with federal monies, and construction projects will require a formal Section 106 Review by the THC. This review will take place following the grant awards. Failure to obtain a review will result in forfeiture of the CLG Grant. The CLG State Coordinator will provide additional guidance once the grants are awarded. Additional information regarding Section 106 Review is available from the THC and the Advisory Council on Historic Preservation.

MATCHING FUNDS

Proposed projects are required to provide a local match for grant monies budgeted on a one-to-one (dollar for dollar) match equal to a 50-50 ratio for the total cost of the project. The local match may be any combination of cash and verifiable in-kind services. Projects may utilize all or partial match of verifiable in-kind services and/or goods as long as the local match equals a 50-50 ratio for the total cost of the project. For example, if a CLG has a project that costs \$40,000 and applies for a \$20,000 grant, the CLG may match \$15,000 in cash, and \$5,000 in staff services. It is important to note that the grant is reimbursement based, meaning the CLG will need to spend the grant amount plus the match upfront (\$40,000), and be reimbursed for the grant amount (\$20,000) as project milestones are achieved, or at the completion of the project.

ITEM 12

Elia Garcia
Mayor

Rene Rodriguez
Representative
At Large

Cesar Nevarez
District 1
Mayor Pro-Tem



Ralph Duran
District 2

Victor Perez
District 3

Yvonne Colon-Villalobos
District 4

Adriana Rodarte
City Manager

DATE: November 5, 2020
TO: MAYOR AND CITY COUNCIL
FROM: Job Terrazas, Building Official
CC: Adriana Rodarte, City Manager

SUBJECT

Consider and Take Action on the final plat approval for Sendero Flores Village, being all of Tracts 4B & 4C, Socorro Grant, Block 27 for a new development.

SUMMARY

The property is easterly located at 300 feet from Socorro Rd. and has an approximate area of 174,240 Sq. Ft. (4.0 acres). This land is owned by Raul Flores.

BACKGROUND

The proposed plat will have a total of 15 residential lots classified R-1 and a public pond. An additional 0.575 acres will be dedicated for public ROW. The additional ROW dedicated will be 20' wide.

According to the Flood Insurance Rate Maps, the referenced property lies within an area determined to be outside of the 500-year flood plain, more particularly described as Zone X.

STATEMENT OF THE ISSUE

The proposed plat will subdivide two tracts of land into a total of 16 sites.

STAFF RECOMMENDATION

The Planning and Zoning Department recommends APPROVAL to allow the applicant to subdivide the land with conditions imposed.

- The required improvements shall be installed prior to the recording of the mylars.

BOARD RECOMMENDATION

The Planning and Zoning Commission recommends APPROVAL.

FINANCIAL IMPACT

Account Code (GF/GL/Dept):

Funding Source:

Amount:

Quotes (Name/Commodity/Price)

Co-op Agreement (Name/Contract#)

ALTERNATIVE

Deny

REQUIRED AUTHORIZATION

- 1. City Manager _____ Date _____
- 2. CFO _____ Date _____
- 3. Attorney _____ Date _____

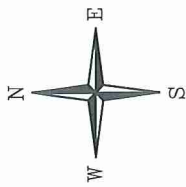

PROJECT SITE;
Tract 4-B Block 27
Socorro Grant

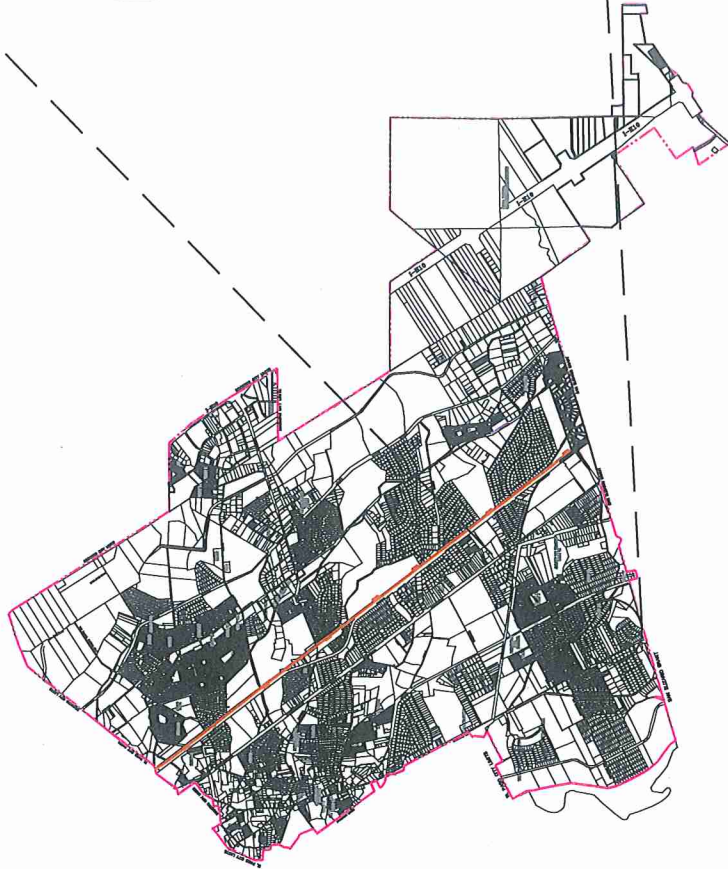
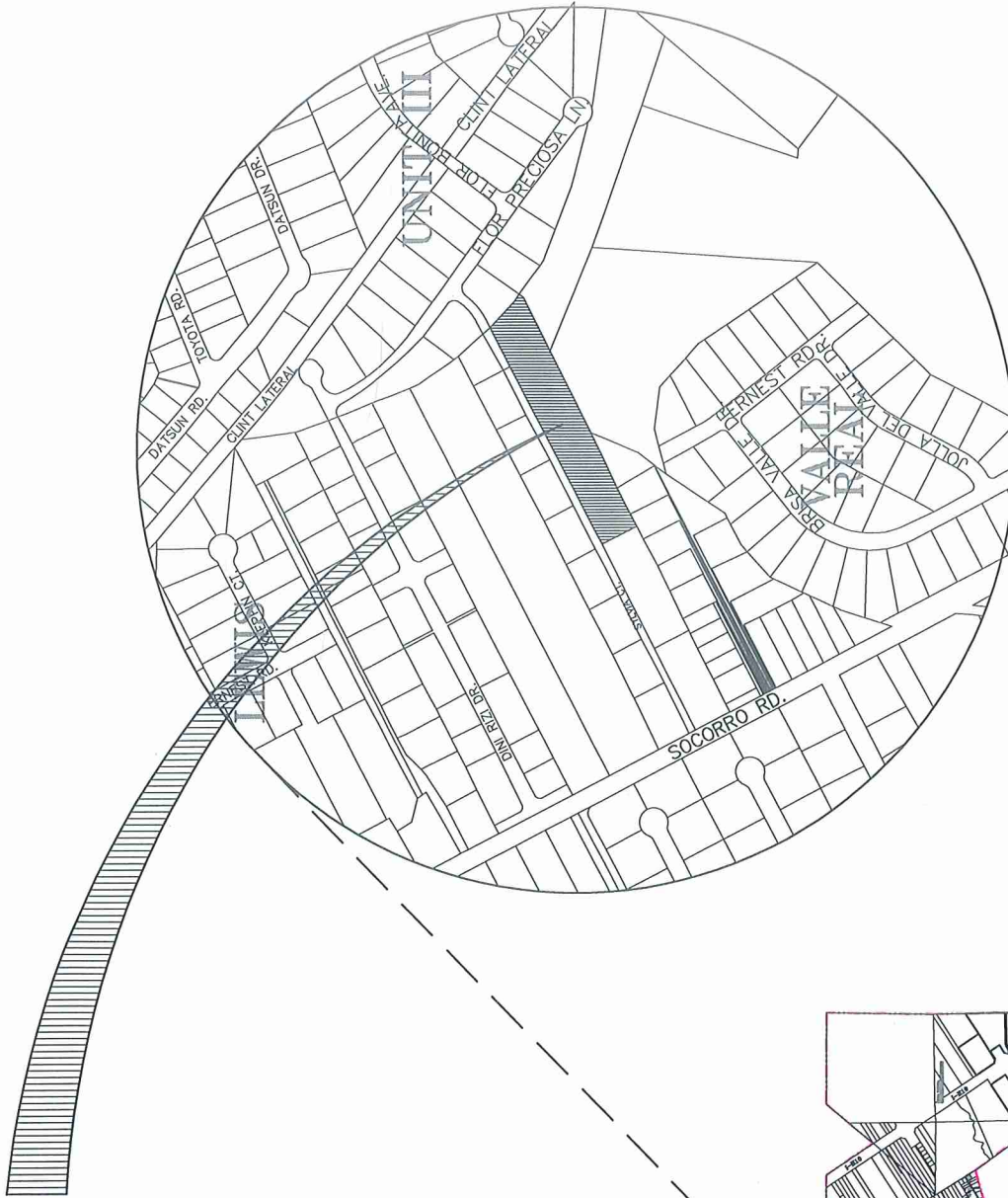

CITY OF SOCORRO



LOCATION MAP

Scale: AS SHOWN

SENDERO FLORES VILLAGE

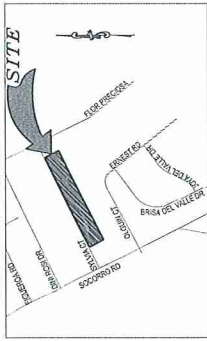

LOCATION MAP
SCALE: 1" = 600'

PLAT NOTES AND RESTRICTIONS:

- 1.-RESTRICTIVE COVENANTS FOR THIS SUBDIVISION ARE FILED IN THE OFFICE OF THE COUNTY CLERK, DEED AND RECORDS SECTION.
- 2.- UNLESS OTHERWISE STATED, SET 7' REBAR WITH CAP AT ALL EXTERIOR BOUNDARY CORNERS.
- 3.-TAX CERTIFICATE FOR THIS SUBDIVISION IS FILED IN THE OFFICE OF THE COUNTY CLERK, DEED AND RECORDS SECTION.
- 4.- LOT CORNERS WILL BE SET UPON COMPLETION OF CONSTRUCTION OF ROADWAYS AND UTILITIES.
- 5.- THIS SUBDIVISION LIES IN AN AREA UNMAPPED BY FEMA.
- 6.-WATER SUPPLY AND SEWAGE DISPOSAL IS BEING PROVIDED BY THE LOWER VALLEY WATER DISTRICT.
- 7.-POSTAL DELIVERY SERVICE WILL BE PROVIDED BY USPS, USING COLLECTION BOXES.
- 8.-THE PROPERTY OWNERS ARE SOLELY RESPONSIBLE FOR COMPLIANCE WITH ALL TITLE COMMITMENT PROVISIONS AND ACCURACY OR DEFECTS OF THIS PLAT.
- 9.-NO MORE THAN ONE SINGLE-FAMILY DETACHED DWELLING SHALL BE LOCATED ON EACH LOT.

TOTAL NUMBER OF PLOTS IN THIS PLAT: 60

SCHOOL DISTRICT: SCCRPO INDEPENDENT SCHOOL DISTRICT

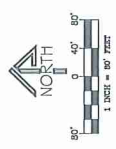

SENDERO FLORES VILLAGE

BEING TRACT 4-B AND 4-C, BLOCK 27,
SOCORRO GRANT,
CITY OF SOCORRO,
EL PASO COUNTY, TEXAS.

CONTAINING: 4.000 ACRES
DEDICATION

I, RAIL FLORES, AS PROPERTY OWNER OF THE 4.000 ACRES TRACT OF LAND ENCOMPASSED WITHIN THE PROPOSED SENDERO FLORES VILLAGE SUBDIVISION, DO HEREBY DEDICATE TO PUBLIC USE, FOR THE CITY OF SOCORRO, TEXAS, THE FOLLOWING SEWER MAINS, SEWER AND WASTEWATER TANKS, AND FLOODING AREA (LOT 18, BLOCK 27), E.A.W. DEDICATED TO STAMA COURT, AND FLOODING AREA (LOT 18, BLOCK 27).
I CERTIFY THAT I HAVE COMPLIED WITH THE REQUIREMENTS OF TEXAS LOCAL GOVERNMENT CODE § 212.032 AND THAT:
(A) THE WATER QUALITY AND CONNECTIONS TO THE LOTS MEET, OR WILL MEET, THE MINIMUM STATE STANDARDS;
(B) SEWER CONNECTIONS TO THE LOTS OR SEPTIC TANKS MEET, OR WILL MEET, THE MINIMUM STATE STANDARDS; AND
(C) ELECTRICAL CONNECTIONS PROVIDED TO THE LOTS MEET, OR WILL MEET, THE MINIMUM STATE STANDARDS; AND
(D) GAS CONNECTION, IF AVAILABLE, PROVIDED TO THE LOTS, MEET OR WILL MEET THE MINIMUM STATE STANDARDS.
I ATTEST THAT THE MATTERS ASSERTED IN THIS PLAT ARE TRUE AND COMPLETE.

RAIL FLORES _____ DATE _____
ACKNOWLEDGEMENT

STATE OF TEXAS
COUNTY OF EL PASO
I, THE UNDERSIGNED NOTARY PUBLIC, ON THIS PERSONALLY APPEARED RAIL FLORES, PROVIDED TO ME THROUGH HIS REPRESENTATIVE PUBLIC SAFETY DRIVER LICENSE TO BE THE PERSON WHOSE NAME IS SUBSCRIBED TO THE FOREGOING INSTRUMENT AND, WHO, BEING BY HIS FIRST DULY SWORN, DECLARED THAT THE STATEMENTS THEREIN ARE TRUE AND CORRECT AND ACKNOWLEDGED THAT HE EXECUTED THE SAME FOR THE PURPOSES AND CONSIDERATION THEREIN EXPRESSED.
GIVEN UNDER MY HAND AND SEAL OF OFFICE THIS _____ DAY OF _____, 2020.

NOTARY PUBLIC IN AND FOR THE COUNTY OF EL PASO _____ MY COMMISSION EXPIRES _____
CITY OF SOCORRO CERTIFICATE OF PLAT APPROVAL UNDER
TEXAS LOCAL GOVERNMENT CODE 212.009(C) AND 212.0115(B)
WE THE UNDERSIGNED CERTIFY THAT THIS PLAT OF SENDERO FLORES VILLAGE WAS REVIEWED AND APPROVED BY THE CITY OF SOCORRO, TX, ON THIS _____ DAY OF _____, 2020.
MAYOR OF THE CITY OF SOCORRO _____ DATE _____ ATTNEY SECRETARY OF THE CITY OF SOCORRO _____

COUNTY CLERK'S RECORDING CERTIFICATE
I, _____, COUNTY CLERK OF EL PASO COUNTY, CERTIFY THAT THE PLAT BEARING THIS RECORDS OF THE EL PASO COUNTY.

EL PASO COUNTY CLERK
FINAL PLAT
DATE OF PREPARATION: JULY 28, 2020.

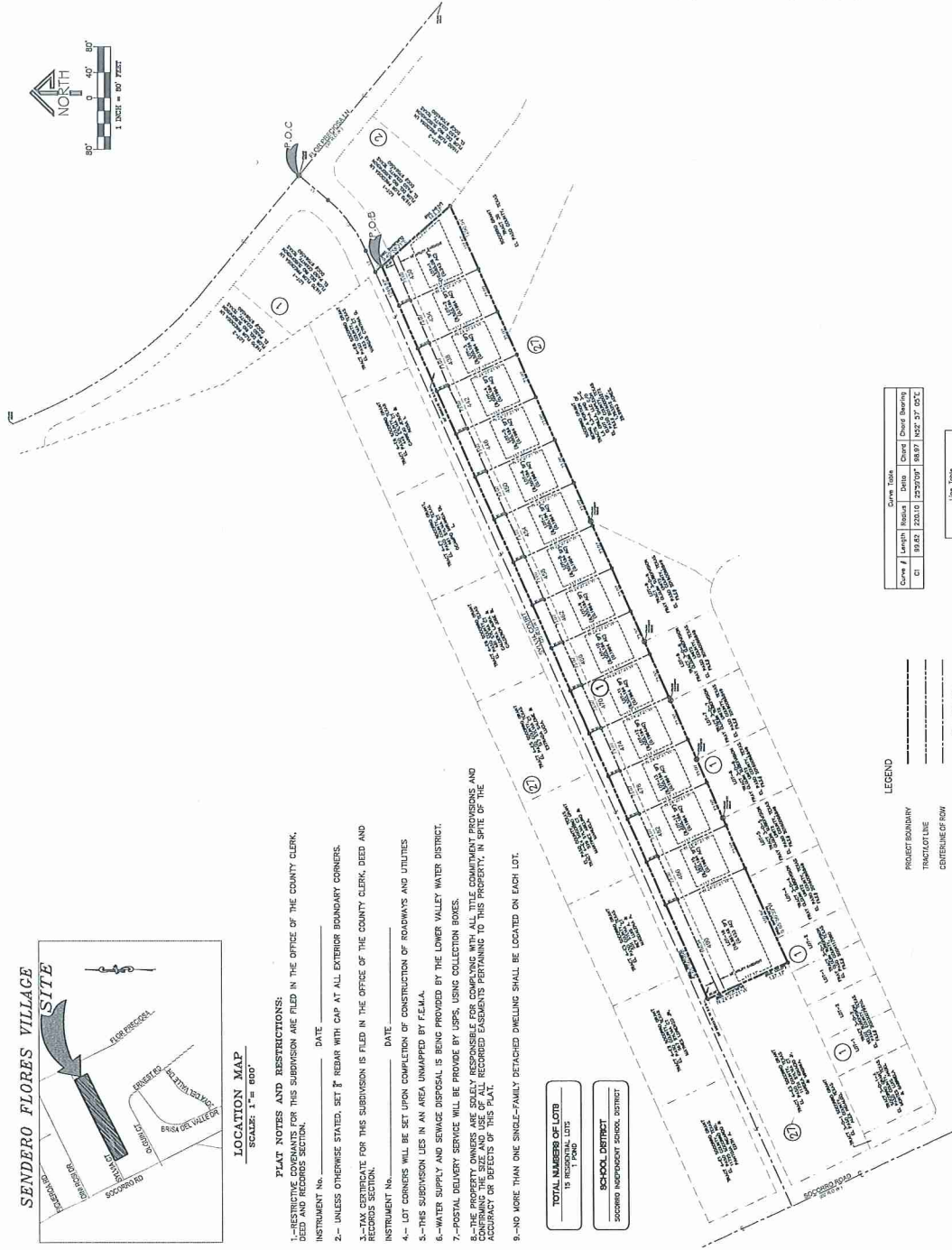

Curve #	Length	Radius	Delta	Chord	Chord Bearing
C1	39.82	720.10	125.03°	18.07	N82° 37' 05"E

Line #	Length	Direction
L1	60.00	N37° 37' 31"E
L2	34.14	S92° 59' 39"W
L3	13.32	N42° 38' 21"W

LEGEND

- PROJECT BOUNDARY (dashed line)
- TRACT/LOT LINE (solid line)
- CENTERLINE OF ROW (dashed line)
- BLOCK NUMBER (circled number)
- POINT OF BEGINNING (circle with 'P.B.')
- POINT OF COMMENCEMENT (circle with 'P.C.')
- EASEMENT (dashed line)
- SET BACK (dashed line)
- RECORDS OF (circle with 'R')

Name:	Address:	City & Zip:	Phone:	Fax:
OWNER: RAIL FLORES	11432 Dobson Rd	EL PASO, TX 79927	(915) 352-0455	
ENGINEER: JARMAN N. COMEZ, P.E.	11385 James West Dr., Suite B13	EL PASO, TX 79936	(915) 351-8701	(915) 243-5010
SURVEYOR: JOSE LUIS RODRIGUEZ, R.P.L.S.	11385 James West Dr., Suite B13	EL PASO, TX 79936	(915) 351-8701	(915) 243-5010

GRV Integrated Engineering Solutions LLC
11385 James West Dr., Suite B13, El Paso, TX 79936
TEL: 915.351.8701 | FAX: 915.243.5010



PLANNING AND ZONING DEPARTMENT
APPLICATION FOR SUBDIVISION APPROVAL

Date 8/25/2020

REQUIRED DOCUMENTS

1. Plat of proposed subdivision done by a registered land surveyor showing easements.
2. Title guarantee by a Certified Abstractor showing that the applicant owns or controls the proposed property and that the property is free from any liens or other encumbrances.
3. Property deed of proposed subdivision.
4. Property Tax Certificate.

Application must be completed and validated prior to subdivision processing.

Section 1: Applicant/Agent Information

Applicant Name: Raul Flores Jr.
Firm: Not Applicable (N/A)
Applicant Mailing Address: 11432 Datsun Drive
City: Socorro State: TX Zip: 79927
Email: raulflores21@aol.com
Phone: (915) 383-0455 Type: Cell

Section 2: Owner Information

Same as Applicant Owner Name: _____
Owner Signature: _____
Firm: _____
Owner Mailing Address: See section 1.

Section 2: Engineer Information

Applicant Name: Marvin H. Gomez, P.E.

Firm: GRV Integrated Engineering Solutions LLC

Applicant Mailing Address: 11385 James Watt Dr., Ste. B13

City: El Paso State: TX Zip: 79936

Email: grvies@gmail.com

Phone: (915) 351-6701 Type: Office

Section 4: Project Information

Subdivision Name: Sendero Flores Village

Subdivision Street Location:

Address: _____

1. Legal description of Area: TRACT 4-B AND 4-C, BLOCK 27 SOCORRO GRANT, EL PASO COUNTY, TEXAS CONTAINING 4.000 ACRES +-
El Paso County, Texas.

—OR—

Approximate distance: _____ direction: _____ from the intersection
of _____ and: _____
on the: _____ side

Description of the Proposed Subdivision:

SUBDIVISION CONSISTS OF CREATING 15 RESIDENTIAL LOTS AND ONE PONDING AREA.

2. Proposed Land Uses:

	Acres	Sites		Acres	Sites
Single Family	0.196+-	14	Office		
Duplex			Street & Alley		
Apartment			Ponding/Drainage	0.433	1
Mobile Home			Institutional		
P.U.D.			Other (Specify)		
Park/Pond			Dedicated ROW	0.575	1
School			Single Family	0.243	1
Commercial			Total No. Sites		
Industrial			Total Acreage	4.000	17

3. Number of lots/units proposed — Single-family: 15 Multifamily: 0
4. What is the existing zoning of the above described property? R-1, Single Family Residential

5. Which of the following public improvements will be installed in this development:

Pavement	Y	Water Lines	
Sidewalks, Curb and Gutter	Y	Street Name Signs	
Storm Sewer	Y	Protective Fence	
Flood Retention Pond	Y	Guardrails	
Fire Protection		Street Lights	
Survey Monuments	Y	U/G Electric Lines	
Sanitary Sewer		Other (Specify)	

6. What type of telephone easements are proposed?
 Underground _____ Overhead _____ Both X

What type of electrical easements are proposed?
 Underground _____ Overhead _____ Both X

What type of cable T.V. easements are proposed?
 Underground _____ Overhead _____ Both X

7. What type of drainage is proposed?
 Storm water and flood retention pond

8. Remarks and/or explanation of special circumstances:

Section 5: Inspection Authorization

As owner or authorized agent, my signature authorizes staff to visit and inspect the property for which this application is being submitted.

Please type or print Name below Signature, and indicate Firm represented, if applicable:

Marvin Gomez _____ 08/27/2020
 Signature Month Day Year

Marvin H. Gomez, P.E.
 Name (Typed or Printed)

GRV Integrated Engineering Solutions LLC
 Firm

ITEM 13

Elia Garcia
Mayor

Rene Rodriguez
At Large

Cesar Nevarez
District 1



Ralph Duran
District 2

Victor Perez
District 3 / Mayor Pro Tem

Yvonne Colon-Villalobos
District 4

Adriana Rodarte
City Manager

November 2, 2020

TO: MAYOR AND CITY COUNCIL MEMBERS

FROM: City Manager, Adriana Rodarte

SUBJECT: Discussion and action to approve a Neighborhood Traffic Management Pilot Program

SUMMARY

The Neighborhood Traffic Management Program (NTMP) addresses speeding and cut-through traffic on local residential streets using a set of traffic-calming tools. These include physical tools, such as speed tables, road diets, and realigned intersection, as well as non-physical tools like speed reduction markings and targeted police enforcement.

STATEMENT OF THE ISSUE

Neighborhood Traffic Management Pilot Program will function as a tool to mitigate observed traffic concerns.

FINANCIAL IMPACT

Account Code (FUND/GL CODE/DEPT./GRANT CODE/ FUNCTION):
0003/001/05312

Funding Source: General Fund

Amount: \$15,000.00 (for pilot program)

Quotes (Name/Commodity/Price):

Co-op Agreement (Name/Contract#):

ALTERNATIVE

Postpone or deny

STAFF RECOMMENDATION

Staff is recommending approval

REQUIRED AUTHORIZATION

1. City Manager _____ Date _____
2. CFO _____ Date _____
3. Attorney _____ Date _____

City of Socorro

NEIGHBORHOOD TRAFFIC MANAGEMENT PROGRAM

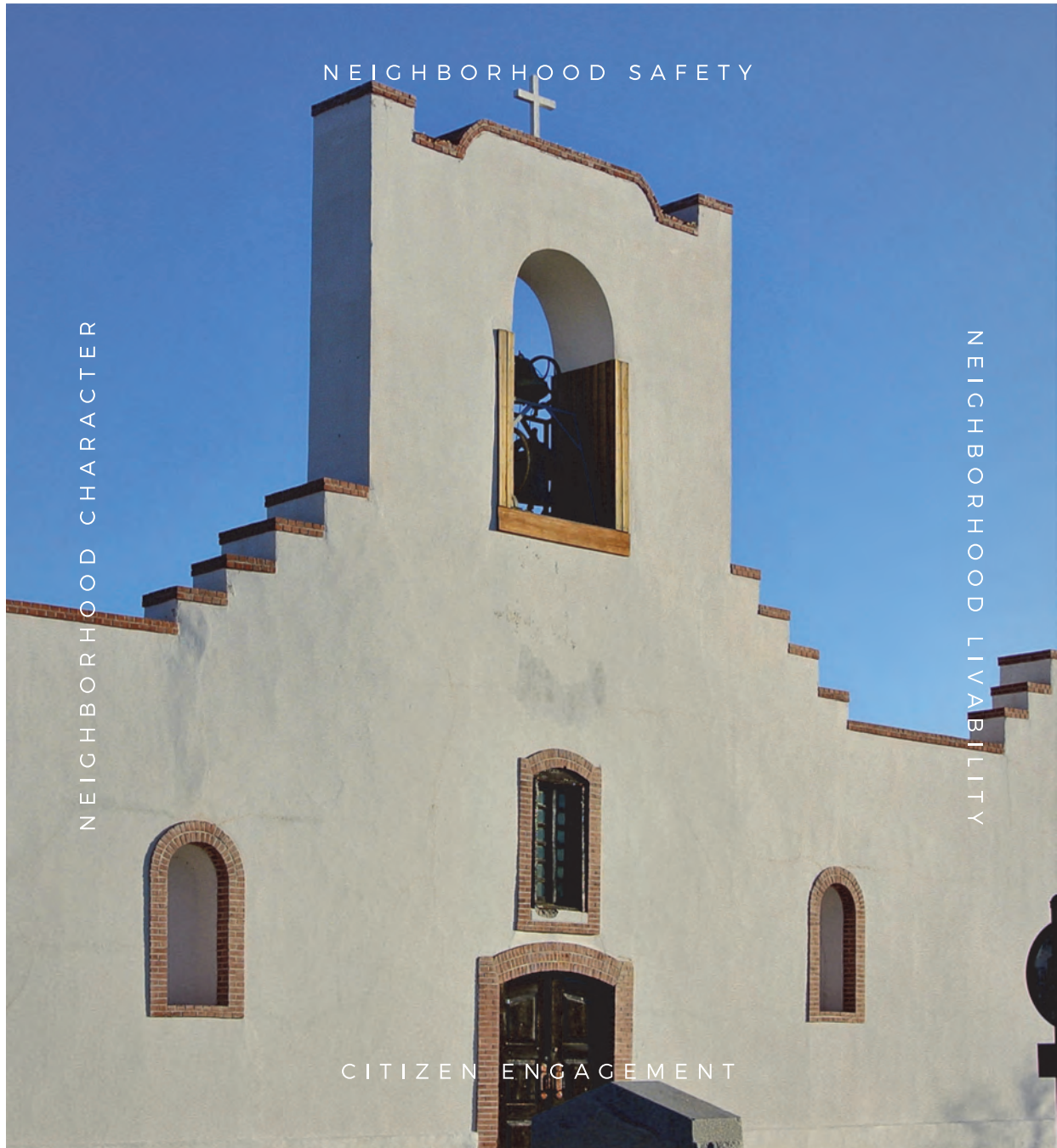

NEIGHBORHOOD SAFETY

NEIGHBORHOOD CHARACTER

NEIGHBORHOOD LIVABILITY

CITIZEN ENGAGEMENT



TABLE OF CONTENTS

EXECUTIVE SUMMARY

SECTION I Introduction

SECTION II Implementation
Process

SECTION III Traffic Management
Strategies

SECTION IV Neighborhood
Traffic Calming
Measures Toolbox

SECTION V Forms



This Neighborhood Traffic Management Program (NTMP) policy manual was developed for the City of Socorro (City). This manual represents a collaborative effort between City management, staff, and stakeholders to develop a citywide policy to better manage neighborhood traffic, address citizen concerns, and outline an open and transparent process on how traffic calming projects are identified, prioritized, and implemented.

EXECUTIVE SUMMARY

The Neighborhood Traffic Management Program (NTMP) addresses speeding and cut-through traffic on local residential streets using a set of traffic-calming tools. These include physical tools, such as speed tables, road diets, and realigned intersection, as well as non-physical tools like speed reduction markings and targeted police enforcement.

Traffic Management Procedure

This manual outlines the process by which neighborhoods may request traffic calming, establishes the criteria for determining applicability and appropriate measures, and the toolkit of traffic calming strategies. The procedure for requests for traffic calming is as follows:

1. Residents, property owners, or homeowner's association or neighborhood association president/board member apply for traffic calming.
2. Planning and Zoning Department assesses whether the street segment meets the minimum thresholds established in the NTMP Initial Assessment:

Initial Assessment for NTMP Requests

This process will be evaluated by the City of Socorro's Planning and Zoning Department to determine if the request will meet preliminary criteria as described in the Neighborhood Traffic Management Program (NTMP) document. The proposed process for the NTMP is as follows:

1. Any roadway that is greater than a collector roadway is not eligible for traffic calming. Classifications of roadways are determined by the city's planning department and El Paso Metropolitan Planning Organization.
2. The roadway must be used to provide access to abutting residential properties (local residential street) and/ or to collect traffic for such streets (residential collector).
3. There must be no more than one moving lane of traffic in each direction.
4. Traffic volumes must be more than 500 vehicles per day.
5. The roadway must be paved and have a speed limit of 20-30 MPH as determined in accordance with State Law.
6. The roadway segment must be a 1/3 mile or more in length and must be continuous without interruption by a traffic control device.
7. The application for traffic calming must be completed by a total of 10 residents, or 2/3 of residents if less than 10 exist, that are affected by the roadway segment. Information

must be provided to ensure neighborhood is in agreement for new traffic calming measure. A president or board member representing a homeowner's association or neighborhood association may also file an application.

8. A petition shall be sent by the designated neighborhood contact to the City Clerk. The petition must be complete and signed by two-thirds of the affected property owners for that street segment being considered. Affected property owners will be determined by the city.

Note: The application will then be considered only upon completion of these steps. Incomplete application(s) will not be processed. For requests made, you may check back within 4-6 weeks for status of application.

Priority Listing for NTMP Requests

After the request passes the initial assessment, a priority listing will be executed for NTMP requests. The proposed priority process is as follows:

1. Residential street sections with at least 51 percent of the houses facing the street for traffic calming.
2. Residential street sections with two or more preventable accidents within 3 years. This would be followed by residential street sections with one or more preventable accidents within 3 years.
3. Residential street sections with 1,000 or more vehicles per day for traffic calming. This will require a traffic count which is less expensive than a full study. This would be followed by residential street sections with 750 vehicles per day for traffic calming. This would be followed by residential street sections with 500 vehicles per day.
4. Collector street sections with 1,000 or more vehicles per day for traffic calming. This would be followed by collector street sections with 750 vehicles per day for traffic calming. This would be followed by collector street sections with 500 vehicles per day for traffic calming.
5. The Planning and Zoning Department will hold a scoping meeting with applicants and other stakeholders to assess the traffic problem.
6. Planning and Zoning Department collects traffic data and analyzes the traffic problem to determine if it meets at least three of the Engineering Criteria established by the NTMP Policy Manual:
 1. Reported crashes in the past 3 years that could be corrected with traffic calming
 2. Peak-hour traffic volume greater than 500 vehicles in one direction

3. 25 percent of peak-hour traffic is non-local cut-through traffic
4. 85th percentile speed exceeds the posted speed limit by 5 mph or more
7. Planning and Zoning Department provides report detailing problem and recommended solutions from Traffic Calming Toolkit.
8. Applicant distributes copies of the report (or instructions on how to obtain it on City website) to households in petition area.
9. Planning and Zoning Department takes feedback and adjusts as necessary, determines priority of project in relationship to other requests, identifies funding or potential sources of funding via capital improvement program.
10. Denial or approval by city council.
11. Implementation, if applicable, by Public Works Department.

A close-up photograph of several large, thick, green aloe vera leaves. The leaves are arranged in a fan-like pattern, with some showing signs of being cut or broken. Numerous small, clear water droplets are scattered across the surface of the leaves, particularly on the central and right-hand leaves. The lighting is soft, highlighting the texture and color variations of the plant matter.

SECTION I - INTRODUCTION

CITY OF SOCORRO
NEIGHBORHOOD TRAFFIC MANAGEMENT PLAN

SECTION I – INTRODUCTION

Section One of the manual introduces and discusses the subject of traffic calming, the goals and objectives of the City's new Neighborhood Traffic Management Program (NTMP), and how to use this manual to petition for and identify appropriate traffic calming measures in neighborhoods throughout the City. This section also provides an explanation of how various neighborhood traffic issues (e.g., speeding and cut-through traffic) are evaluated, what types of streets are included in the neighborhood traffic calming program, and how traffic management projects are identified, selected, and prioritized. Finally, contact information for the NTMP administrator at the City's Planning and Zoning Department is provided.

What is traffic calming?

Many residents are expressing concern about the increase in speeding and cut-through traffic on local residential streets. The Institute of Transportation Engineers (ITE) defines traffic calming as "the combination of mainly physical measures that reduce the negative effects of motor vehicle use, alter driver behavior, and improve conditions for nonmotorized street users." In response to the public's concern for the safety and livability of their neighborhoods, the City has developed this policy manual as a guide for implementing neighborhood traffic calming projects in the City of Socorro.

What are the program's goals and objectives?

The goals of the NTMP are to address neighborhood traffic safety, preserve neighborhood character and livability, and engage residents through neighborhood involvement. The program will identify improvements that meet these goals through a collective understanding among the residents and City staff of neighborhood traffic issues and concerns, as well as potential solutions. Primary goals and objectives of the program include:

- **Improve Neighborhood Traffic Safety.** Excessive traffic speeds are a hazard to neighborhood safety and security. The first goal of this program is to help promote and maintain a safe and pleasant environment for residents, pedestrians, bicyclists, and motorists in the City's neighborhoods.
- **Preserve Neighborhood Character and Livability.** Traffic management plays a vital role in the character and livability of neighborhoods. The measures presented in this manual are intended to reduce the negative effects that automobile use may have in residential areas and increase the livability of the City's neighborhoods.

- **Increase Neighborhood Involvement.** Through the decision-process steps outlined in this manual, residents can assess the various benefits and trade-offs of implementing projects within their own neighborhoods. This policy manual encourages residents to become actively involved in the decision-making process by following the steps outlined to implement traffic calming measures.

How is this manual used?

This NTMP policy manual was developed as a guide for City staff and to inform residents about the processes and procedures for implementing neighborhood traffic calming measures. The manual includes a summary of the City's goals and objectives for the program, as well as a defined process for implementation, and a toolbox of traffic calming measures. The procedures to implement neighborhood traffic calming measures are described in Section II – Implementation Process. Public participation is highly encouraged as is substantial neighborhood involvement. Available funding will be targeted to those projects receiving higher priority ranking through the process. Projects will be prioritized based on identified needs, available funding, and benefits.

How are traffic problems evaluated?

City staff in the Planning and Zoning Department will collect and evaluate traffic data, identify system needs, and using the guidelines in this manual will identify a range of appropriate solutions based on the data and engineering judgment. In order of importance, the following lists the most widely used criteria for determining the need for traffic calming on residential streets:

- Crash frequency – the number and types of crashes is important in understanding multimodal safety and identifying counter measures
- 85th percentile speeds – an industry accepted threshold for assessing speeding
- Traffic volumes and vehicle mix – impacts from automobiles and trucks are different and may require different mitigation measures
- Cut-through traffic volumes – understanding the origin and destination of trips can help tailor traffic calming strategies
- Community/neighborhood input and support – key to the development, implementation, funding, and maintenance of traffic calming plans and devices
- Bicycle and pedestrian activity – protecting these most vulnerable users and providing comfortable environments encourages commuter and recreational use of alternate modes of transportation

- Established and planned public transportation routes – transit users congregate at public transit stations and stops

Because safety is the most important aspect of traffic calming, crash frequency will serve as the primary evaluation criteria. Traffic issues such as speeding and daily volume will serve as secondary criteria. Community support and participation are also important criteria and are critical to the success of the program.

What types of streets are appropriate for neighborhood traffic calming?

This NTMP has been created for residential streets which are functionally classified as either local or collector roadways. The traffic calming measures presented in this manual are not typically suitable for streets with higher functional classifications such as major or minor arterial roadways. Functional classification maps are available from the Planning and Zoning Department.

How will projects be selected?

After a submitted application has been reviewed and compared successfully against the evaluation criteria, it will be considered for implementation. Based on the process defined in Part II of this manual, requests for traffic calming measures will be presented to the city council for recommendations into the capital improvement program or for immediate implementation based on available funds. The project applicants will be notified of the resulting city council action(s).

How will projects be prioritized and funded?

The highest-ranking projects will be included in the City's Capital Improvement Program (CIP) and will be implemented as funding is available. The number of implemented projects will depend on the City's fiscal resources. Previously qualifying projects will not have to be reevaluated and will remain on the priority list. Projects will continue to be ranked for up to 5 years, at which point they will no longer be considered. This time condition has been set to ensure that projects do not become outdated due to changes in resident concerns and traffic conditions.

How will the effectiveness of projects be measured?

Once projects have been constructed and operational for at least 6 months, a post-implementation evaluation will be conducted by the Planning and Zoning Department. This evaluation will consist of a technical memorandum that determines whether the traffic calming measures, or devices have been effective, whether any changes or additional measures are required, or whether, due to ineffectiveness or other undesirable effects, devices should be removed.

This process will answer the following questions:

- Has the traffic calming measure been effective?
- Has it accomplished the desired goal?
- Has it created undesirable adverse effects?
- If implemented on a trial basis, should a more permanent traffic calming measure be constructed?
- Are additional measures needed to enhance effectiveness?

Who should residents contact?

If a resident or neighborhood group believes they have neighborhood traffic issues that may be addressed through traffic calming, they are encouraged to apply using one of several methods. The preferred method for requesting Neighborhood Traffic Management is by using the online form located on the City's website:

Website: <http://ci.socorro.tx.us/planning-zoning/>

You may also print the form located at the end of this document and hand deliver, send via U.S. Mail, or e-mail to:

Mailing Address:

NTMP Request
c/o City Clerk
City of Socorro
124 S. Horizon Blvd.
Socorro, Texas 79927

Email Address:

cityclerk@ci.socorro.tx.us



SECTION II - IMPLEMENTATION PROCESS

CITY OF SOCORRO
NEIGHBORHOOD TRAFFIC MANAGEMENT PLAN

SECTION II – IMPLEMENTATION PROCESS

This section of the manual discusses the implementation process for the NTMP, including definition of the qualifying criteria for traffic calming measures and an outline of the process and steps residents and neighborhood groups would take to petition for implementing traffic calming measures in their neighborhoods. Additionally, this section highlights the expectations and responsibilities of the City and petitioning parties.

How does the decision process work?

The request for traffic calming measures on a neighborhood street can be initiated by a resident, neighborhood group, or homeowners' association with specific concerns about speeding, traffic volume, cut-through traffic, or other traffic issues considered detrimental to the safety and livability of their neighborhood. The plan development and implementation process steps include:

- Preliminary actions
- Implementation measures
- Assessment of effectiveness

Every request for traffic calming will be reviewed by City staff. Upon receipt, staff will determine if the request meets ALL the following three minimum thresholds:

1. Functional classification as a local or collector roadway
2. Has a demonstrated need for traffic management determined through engineering/traffic study or Planning and Zoning Department observation that indicates a high likelihood of three of the following criteria:
 - Reported crashes in the past 3 years that could be corrected with traffic calming
 - Peak-hour traffic volume greater than 500 vehicles in one direction
 - 25 percent of peak-hour traffic is non-local cut-through traffic
 - 85th percentile speed exceeds the posted speed limit by 5 mph or more.
3. Has not been considered for traffic calming measures within the last 5 years

Notes:

- a. On designated emergency response routes, only non-physical control measures and those physical control measures that do not slow emergency vehicles will be considered.*

- b. Only non-physical control and narrowing measures will be considered on roadways with daily traffic exceeding 3,000 vehicles per day.*
- c. The analysis phase of the Implementation Process described herein will consider unique street characteristics, such as curves, grades, or other features. Only non-physical control measures and those physical control measures that do not exacerbate known existing conditions caused by such characteristics will be considered.*

Only after a street or area meets all three of these minimum criteria will it qualify for traffic calming evaluation and implementation. City staff will communicate to the applicant the NTMP framework and sequence of steps necessary to implement traffic calming.

The preliminary actions include Steps 1, 2, and 3 as part of the project Initiation and Scoping, and Steps 4 and 5 under Evaluation and Development. These steps are described in detail below.

Initiation and Scoping

Step 1: Application

All City residents are eligible to apply for participation in the NTMP. Applications for participation in the NTMP are available via mail, email, and website. Completed applications should be returned to the City Clerk.

Upon receipt of a completed application, the Planning and Zoning Department will perform a search for applicable data. Data are considered applicable if it has been collected by Planning and Zoning Department or a City approved contractor no more than 3 years prior to the application. On the application, it is important to note significant changes, such as a new adjacent development, that have affected traffic within a neighborhood because these changes can be used to determine the applicability of data. If no data are available, Planning and Zoning Department will plan for field observations or data collection as necessary and will inform the applicant of any extra time and/or funds this may require.

The Planning and Zoning Department will respond in writing to the applicant. The response will indicate if the minimum criteria, as described in this manual, have been met, or whether additional observation and data collection will be necessary. If the application has applicable data but the minimum criteria are not met, the application will be denied, and a date will be

provided for the current data expiration. Applicants must re-apply for participation if they would like a neighborhood to be considered after the data has expired. If the three minimum guidance criteria are met, the application will be accepted by the Planning and Zoning Department, the applicant will continue to Step 2.

Step 2: Petition

After receipt of an application, Planning and Zoning Department will determine whether there is applicable data or whether funding is available to collect new data, and the applicant will be provided with a petition form. This petition form will be accompanied by a map of the area as determined by the Planning and Zoning Department based on NTMP guidelines.

A petition will be considered complete if two-thirds of the affected property owners have signed the petition. The petition process is used by the Planning and Zoning Department only to determine if there is enough neighborhood support to expend City staff resources on data collection. The Planning and Zoning Department may modify or expand the petition area to address unique circumstances. Planning and Zoning Department will identify these circumstances and provide written explanation to the applicant for any changes to the petition area.

Upon completion of a successful petition, the Planning and Zoning Department will add the area and traffic concern, as described on the initial application, to a list of data collection and analysis needs.

Step 3: Scoping Meeting

City staff, if needed, will conduct an initial scoping meeting with the petitioning resident or neighborhood group. This meeting will be a collaborative working meeting to discuss the study area, understand the neighborhood traffic issues, define the data collection effort, and provide specifics on the analysis that will be conducted. The petitioner and city staff may visit the neighborhood to observe firsthand the traffic issues and concerns. The scoping meeting will serve as an opportunity for City staff to communicate to residents the next steps in the process, scope of the program, sources and limitations of funding, and current and ongoing education and enforcement efforts. Residents are encouraged to attend the scoping meeting and voice their concerns.

Evaluation and Development

Step 4: Analysis

Once a clear understanding of the neighborhood traffic issues is reached and the extent of the study area has been defined, City staff will collect the necessary data to perform the needed engineering traffic analysis. This analysis will demonstrate whether a traffic issue meets three or more of the following threshold criteria for traffic calming measures:

- Reported crashes in the past 3 years that could be corrected with traffic calming
- Peak-hour traffic volume greater than 500 vehicles in one direction
- 25 percent of peak-hour traffic is non-local cut-through traffic
- 85th percentile speed exceeds the posted speed limit by 5 mph or more.

The data used in the analysis will be readily available to the applicant. If the analysis shows that the issue meets three or more of the minimum thresholds shown above, city staff will use physical and nonphysical traffic management strategies to assess the extent of the neighborhood's traffic problems.

The results of the engineering traffic analysis and the toolbox of traffic calming measures described in Section IV of this manual will be used to develop neighborhood traffic calming plans and identify specific traffic calming measures that are recommended for implementation.

Step 5: Report

The Planning and Zoning Department will summarize the results of the analysis and prepare a recommendation report. The recommendation report will consist of a summary of the scoping meeting, data collected, analysis conducted, preliminary findings, and recommended traffic calming measures. Planning and Zoning Department shall make the report available as a pdf on the City website and provide the report via e-mail to the applicant. The applicant shall provide the City Clerk with a form signed, by that applicant, acknowledging that they have provided the report to all affected neighborhood associations registered with the City, and that they have attempted to contact all households in the petition area to either provide the report or information on how to access it on the City website.

Once a traffic calming plan has been developed, has neighborhood support, and is suggested for implementation by City staff, Steps 6, 7, and 8 outline the actions needed to obtain approval and funding.

Approval and Funding

Step 6: Recommendations

The Planning and Zoning Department will update the traffic engineering report based on the feedback from the public and make final recommendations. Specific devices and locations for traffic calming measures will be identified and recommended for implementation. As projects near the top of the priority list, the Planning and Zoning Department will refine the cost estimate.

Step 7: Identify Funding

Requests for NTMP funding for projects must compete with other requests for traffic calming funding and will be ranked City-wide based on their evaluation. The highest-ranking projects will be implemented first, and the number of projects executed will depend on the City's resources. Projects will continue to be ranked for up to 5 years, at which point they are no longer considered. This time condition has been set to ensure that projects do not become outdated due to resident and traffic condition changes. Nothing in this section shall prevent earlier implementation if funding is identified for a given project by city council.

Step 8: Implementation

Projects may be implemented on a temporary or permanent basis. Non-physical measures will be implemented first because they are easiest to install and are the least expensive. If the effects of a traffic calming measure are uncertain, it may be implemented initially on a temporary basis. Once a device or series of devices has proven effective, permanent traffic calming measures may be constructed.

Once projects have been constructed and operational for at least 6 months, a post-implementation evaluation process will be conducted. Steps 9 and 10 outlines how this process will determine whether the devices have been effective, if any changes or additional measures are required, or whether, due to ineffectiveness or other undesirable effects, the devices should be removed.

Performance and Documentation

Step 9: Performance Evaluation

The Planning and Zoning Department may revisit and reevaluate the traffic calming measures that have been implemented by conducting a post-implementation study. This study shall determine if the traffic calming measures have been effective and if they accomplished their desired goal by using the same criteria identified in Step 4. Any unanticipated or undesirable effects will be noted, and ineffective devices will be removed. If a device was implemented on a temporary or trial basis, the Planning and Zoning Department will determine if a more permanent traffic calming measure should be constructed. Finally, any additional measures that could enhance the effectiveness or improve overall neighborhood traffic calming will be identified.

Step 10: Summary and Conclusion

The Planning and Zoning Department may document the results of the post-implementation study and make recommendations on whether to maintain, improve, and/or remove traffic calming measures. Based on the initial operational period, the Planning and Zoning Department may assess the extent and cost of maintenance for future planning.

A close-up photograph of a yellow school bus. The focus is on the side of the bus, showing a red octagonal stop sign with the word "STOP" in white letters. Two red circular lights are mounted on the sign. The bus's body is yellow, and a black window frame is visible. The background is blurred, showing another bus and a green field under a blue sky.

SECTION III - TRAFFIC MANAGEMENT STRATEGIES

CITY OF SOCORRO
NEIGHBORHOOD TRAFFIC MANAGEMENT PLAN

SECTION III – TRAFFIC MANAGEMENT STRATEGIES

This section of the NTMP policy manual describes the strategies and intent of typical traffic control devices and the different levels of neighborhood traffic calming measures used by the City. This section explains the use of stop signs and pavement markings and discusses the potential removal of unwarranted traffic control devices. For traffic calming measures addressing speed and traffic volumes, an explanation of the expected effectiveness and performance measures is discussed. There are two primary types of traffic management strategies: non-physical and physical measures.

Non-Physical Traffic Management Strategies

Non-physical strategies provide a non-invasive form of calming traffic that is inexpensive and easy to implement, and that can also be removed easily if the measure is unsuccessful. For these reasons, non-physical measures will be applied prior to implementing any physical traffic calming measures. Non-physical traffic calming strategies can take multiple forms. A discussion of some of the most common non-physical strategies is provided below.

- **Safety Education and Community Involvement** involves efforts to make the public mindful of their own driving behavior and the impact it has on others. Programs are often centered on promoting safe and lawful driving habits and may include programs geared toward drivers, bicyclists, pedestrians, or safe interaction amongst all users. Public meetings can provide a means for communicating concerns to City staff while allowing residents to share views and form consensus.
- **Police Enforcement** involves the presence of police officers to monitor speeds and issue citations for law violations such as stop sign, speed limit, turn restriction, and other traffic law violations. Visible presence is highly effective while an officer is present. Police enforcement can be useful for implementation of a new traffic calming measure, as well as provide a visible reminder of existing measures.
- **Pavement Markings** include a variety of painted roadway guidance such as various forms of striping and painted markings and raised pavement markers. Painted striping and raised pavement markers are used to reduce travel lane widths, making drivers feel more restricted and thereby reducing their speeds. Striping is also used to create higher visibility for pedestrians at crosswalks and separate bike traffic from vehicle traffic. Painted markings are associated with reminding drivers of regulations such as speed limits, appropriate turn movements, or shared-use facilities. Painted markings

and pavement markers may also be used to provide added visibility. Pavement markings are relatively easy and low-cost to install, maintain, and modify. Markings can reduce speeds, prevent unwanted turn movements, and heighten driver awareness.

- **Signage** may be used for a variety of warnings, regulations, and restrictions. Regulatory signs, such as speed limit signs are a useful way to remind drivers of the regulatory speed limit in their neighborhood. Signed turn restrictions may be installed to prohibit certain movements at an intersection at certain times of day in cases where cut-through traffic is common. Signage may also be added to restrict certain types of vehicles on neighborhood streets. While tools like radar speed units are indeed physical devices placed along the road, they are included in the non-physical category because they do not physically slow or divert traffic by causing vehicles to have to drive over or around them. Signage can reduce or restrict unwanted traffic and provide clear definitions of legal speed limits or provide other warnings and reminders. Signage is not self-enforcing and may decrease the aesthetics of a neighborhood or increase traffic on unintended streets.

Note: *Stop signs are not included as a traffic calming strategy in this manual as they are not intended as a traffic calming device. Stop signs are intended to assign right-of-way at intersections. Guidance for their placement is included in the Texas Manual on Uniform Traffic Control Devices. Multi-way stop control should not be installed at an intersection as a speed control measure; studies have shown that stop signs are ineffective for this purpose. Furthermore, unwarranted multi-way stops illicit poor compliance from drivers and create a lack of respect for stop signs in general. Unwarranted stops increase accidents and diminish safety, especially for pedestrians and children, and they increase noise and pollution from vehicles stopped at the intersection.*

Physical Traffic Management Strategies

Physical strategies consist of physical changes in the roadway design for the purpose of reducing the average roadway speed (speed management) or daily traffic volume (volume management), improving the vehicle pedestrian design, or a combination of these elements. Physical strategies may be considered in instances where non-physical strategies have first been implemented, evaluated, and found to be unsuccessful. Physical strategies are discussed below.

- Speed Management can be achieved through either horizontal or vertical measures. Horizontal speed management strategies include treatments that create physical horizontal deviations or deflections in the roadway with the purpose of influencing driver behavior by physically changing the driver's path. Examples of horizontal speed strategies include traffic circles, roundabouts, and lateral shifts. Vertical speed management strategies refer to physical treatments that involve vertical displacement to influence speed through ride discomfort. Examples of vertical speed strategies include speed humps, raised crosswalks, and rumble strips.

Physical speed management strategies offer the benefit of self-enforcing speed limits and enhancing pedestrian safety. Additionally, horizontal speed strategies can often be designed to add aesthetic value to neighborhoods. Some concerns of physical speed management strategies include the higher cost compared to non-physical measures, emergency service limitations, increased noise and air pollution for some strategies, and difficulty of removal if they prove ineffective.

- Traffic Volume Management strategies include treatments that are intended to reduce and redirect traffic movements but are unlikely to have a significant influence on operating speeds. Examples of traffic volume management strategies include closures, diagonal diverters, and forced turn islands. Traffic volume strategies are effective at reducing or eliminating cut-through traffic and can often reduce speeds as well. The main concerns of traffic volume management strategies are their cost, additional delays for emergency vehicles and residents, and the potential for diverting cut-through traffic to adjacent streets.
- Removal of an Unwarranted Traffic Control Device is sometimes needed to improve traffic management. The overuse of traffic control devices, particularly stop signs, can desensitize drivers and lead to noncompliance. The MUTCD explicitly states that stop signs should not be used for speed control. If the total bicycle, pedestrian, and vehicular traffic entering an intersection from all approaches is less than 2,000 vehicles per day, a four-way stop may not be warranted. When determined through engineering study, four-way-stop controlled intersections may be converted to two-way stops.

An aerial photograph of a residential street intersection. The main road is paved with dark asphalt and has white lane markings. A roundabout is visible, featuring a central island with a single green tree. The surrounding area includes a swimming pool with blue water, green lawns, and various trees and shrubs. The overall scene is well-maintained and suburban in style.

SECTION IV - NEIGHBORHOOD TRAFFIC CALMING MEASURES TOOLBOX

CITY OF SOCORRO
NEIGHBORHOOD TRAFFIC MANAGEMENT PLAN

SECTION IV – NEIGHBORHOOD TRAFFIC CALMING MEASURES TOOLBOX

This section of the manual provides a detailed toolbox of traffic calming measures for use in developing neighborhood traffic calming plans. Each measure includes a brief description, noted positive and negative aspects, and an accompanying illustration or photograph. In selecting the correct set of tools to address an identified and documented problem, it is important to understand these considerations, as well as the initial and long-term costs associated with each tool.

The toolbox is divided into two categories:

1. Non-Physical Measures
2. Physical Measures

The city council may direct an amendment or update of the NTMP manual to incorporate best practices devices to address neighborhood traffic management concerns. City staff has authority to implement broad non-physical measures devices, as such, are too numerous to document, however, the physical measures devices are described in detail in the following pages of this manual.

Sections V of this manual include application forms for initiating a request for neighborhood traffic calming, as well as a neighborhood sign-up sheet for required signatures.

PHYSICAL MEASURES

Bulb-Out/Corner Extension

Description:

- Horizontal extension of the sidewalk into the street, resulting in a narrower roadway section
- If located at a mid-block location, it is typically called a choker

Applications:

- When combined with on-street parking, a corner extension can create protected parking bays
- Effective method for narrowing pedestrian crossing distances and increase pedestrian visibility
- Appropriate for arterials, collectors, or local streets
- Can be used on one-way and two-way streets
- Installed only on closed-section roads (i.e. curb and gutter)
- Appropriate for any speed, provided an adequate shy distance is provided between the extension and the travel lane
- Adequate turning radii must be provided to use on bus routes



(Source: James Barrera, Horrocks, NM)

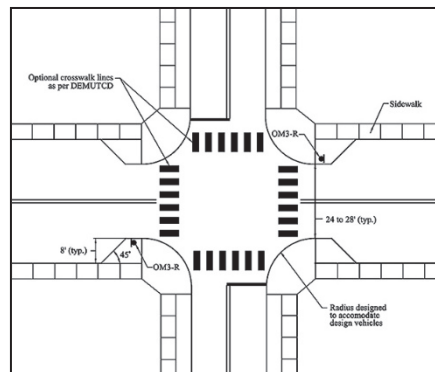

(Source: Delaware DOT)

Design/Installation Issues:

- Effects on vehicle speeds are limited due to lack of deflection
- Must check drainage due to possible gutter realignment
- Major utility relocation may be required, especially drainage inlets
- Typical width between 6 and 8 feet
- Typical offset from travel lane at least 1.5 feet
- Should not extend into bicycle lanes

Potential Impacts:

- Effects on vehicle speeds are limited due to lack of deflection
- Can achieve greater speed reduction if combined with vertical deflection
- Smaller curb radii can slow turning vehicles
- Shorter pedestrian crossing distances can improve pedestrian safety
- More pedestrian waiting areas may become available
- May require some parking removal adjacent to intersections

Chicane

Description:

- A series of alternating curves or lane shifts that force a motorist to steer back and forth instead of traveling a straight path
- Also called deviations, serpentine, reversing curves, or twists

Applications:

- Appropriate for mid-block locations but can be an entire block if it is relatively short
- Most effective with equivalent low volumes on both approaches
- Appropriate speed limit is typically 35 mph or less
- Typically, a series of at least three landscaped curb extensions
- Can use alternating on-street parking from one side of a street to the other
- Applicable on one-lane one-way and two-lane two-way roadways
- Can be used with either open or closed (i.e. curb and gutter) cross-section
- Can be used with or without a bicycle facility

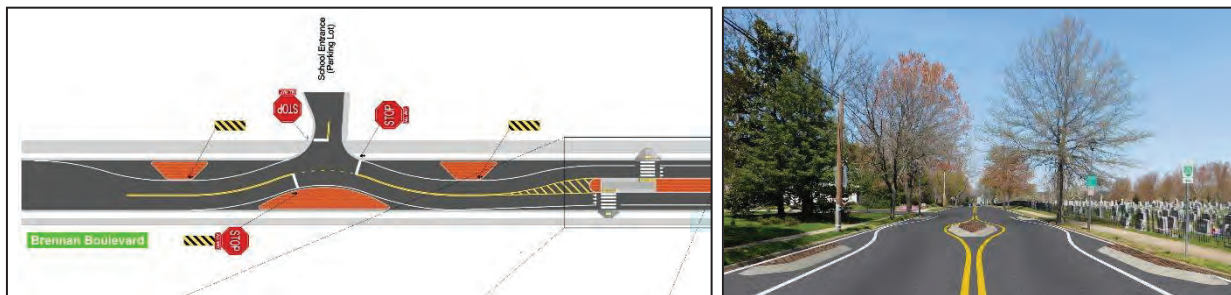

(Source: Delaware Department of Transportation)

Design/Installation Issues:

- Chicanes may still permit speeding by drivers cutting straight paths across the center line
- Minimize relocation of drainage features
- May force bicyclists to share travel lanes with motor vehicles
- Maintain sufficient width for ease of emergency vehicles and truck throughput

Potential Impacts:

- No effect on access, although heavy trucks may experience challenges when negotiating
- Limited data available on impacts to speed and crash risk
- Street sweeping may need to be done manually
- Minimal anticipated volume diversion from street
- May require removal of some on-street parking
- Provides opportunity for landscaping
- Unlikely to require utility relocation
- Not a preferred crosswalk location
- Bus passengers may experience discomfort due to quick successive lateral movements

Choker

Description:

- Curb extension is a lateral horizontal extension of the sidewalk into the street, resulting in a narrower roadway section
- If located at an intersection, it is called a corner extension or a bulb-out
- If located midblock, it is referred to as a choker
- Narrowing of a roadway through the use of curb extensions or roadside islands

Applications:

- Can be created by a pair of curb extensions, often landscaped
- Encourages lower travel speeds by reducing motorist margin of error
- One-lane choker forces two-way traffic to take turns going through the pinch point
- If the pinch point is angled relative to the roadway, it is called an angled choker
- Can be located at any spacing desired
- May be suitable for a mid-block crosswalk
- Appropriate for arterials, collectors, or local streets

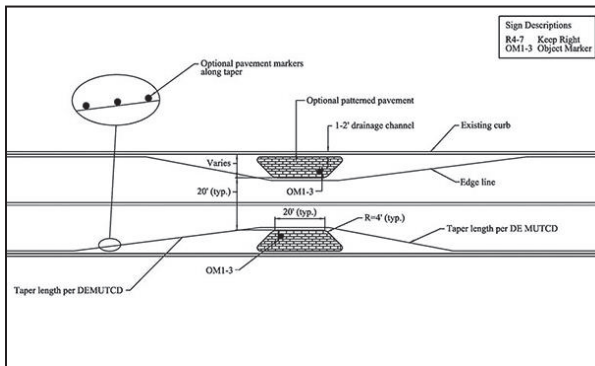

(Source: City of An Arbor, Michigan)

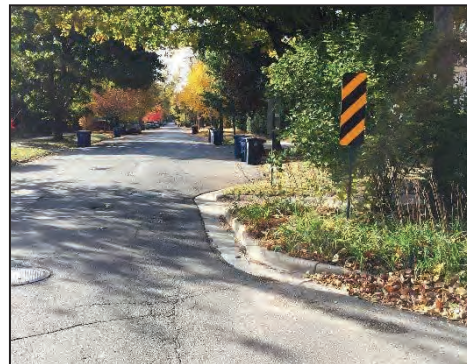

(Source: Delaware DOT)

Design/Installation Issues:

- Only applicable for mid-block locations
- Can be used on a one-lane one-way and two-lane two-way street
- Most easily installed on a closed-section road (i.e. curb and gutter)

- Applicable with or without dedicated bicycle facilities
- Applicable on streets with, and can protect, on-street parking
- Appropriate for any speed limit
- Appropriate along bus routes
- Typical width of 6 to 8 feet; offset from through traffic by approximately 1.5 feet
- Locations near streetlights are preferable
- Length of choker island should be at least 20 feet

Potential Impacts:

- Encourages lower speeds by funneling it through the pinch point
- Can result in shorter pedestrian crossing distances if a mid-block crossing is provided
- May force bicyclists and motor vehicles to share the travel lane
- May require some parking removal
- May require relocation of drainage features and utilities

Closure

Description:

- **Half closures** are barriers that block travel in one direction (creates a one-way street) for a short distance on otherwise two-way streets; sometimes called partial closures or one-way closures
- **Full-street closures** are barriers placed across a street to completely close the street to through- traffic, usually leaving open space for pedestrians and bicyclists; they are sometimes called cul- de-sacs, dead-ends, or mini-parks

Applications:

- Appropriate for local streets (half and full), at intersection (half and full), or mid-block (full closure only)
- Typically applied only after other measures have failed or are deemed inappropriate or ineffective
- Typically found on closed-section roadways (i.e. curb and gutter)
- Can be applied with and without dedicated bicycle facilities and on roads with on-street parking
- Often used in sets to make travel through neighborhoods more circuitous
- Not appropriate along bus transit routes
- Can be used to assist crime prevention



(Source: James R. Barrera, Horrocks, NM)

Design/Installation Issues:

- Potential legal concerns
- Can be placed at intersections or mid-block locations
- Barriers may consist of landscaped islands, walls, gates, side-by-side bollards, or other obstructions that result in openings smaller than the width of a typical passenger car

- Appropriate signing needed at entrances to full-closure street blocks
- May require modifications to maintain surface drainage capacity
- Should consider traffic diversion patterns and associated impacts
- Possible to make diverters passable for pedestrians and bicyclists

Potential Impacts:

- Concerns regarding street network connectivity and capacity
- May result in traffic diverting to other local streets (should be used in groups/clusters)
- No significant impact on vehicle speeds beyond the closed block
- Can improve pedestrian crossing safety

Diagonal Diverter

Description:

- Barriers placed diagonally across four-legged intersections, blocking through movements
- Sometimes called full diverters or diagonal road closures

Applications:

- Typically applied only after other measures are deemed ineffective or inappropriate
- Provisions are available to make diverters passable for pedestrians and bicyclists
- Often used in sets to make travel through neighborhoods more circuitous

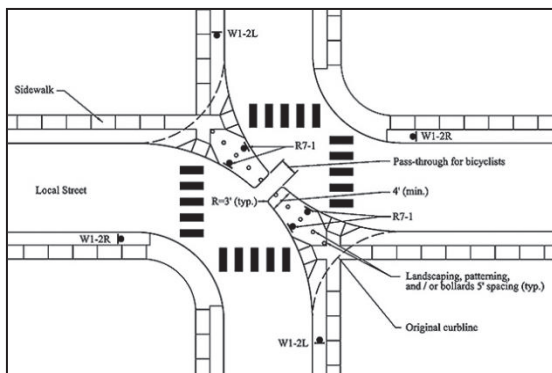

(Source: Delaware DOT)



(Source: PennDOT LTAP)

Design/Installation Issues:

- Possible legal issues associated with closing public streets (e.g., business and/or emergency access)
- Can only be placed at intersections
- Can be used on both one-way and two-way streets
- Typically found on closed-section roads (i.e. curb and gutter)
- Typical maximum appropriate speed limit is 25 mph
- Maintain drainage as necessary to mitigate potential flooding
- Corner radii should be designed to allow full-lane width for passing motor vehicle traffic

- SU-30 default design vehicle
- Appropriate signing and pavement markings needed on approaches
- Openings for pedestrians and bicyclists should allow movement between all intersection legs
- Barriers may consist of landscaped islands, walls, gates, side-by-side bollards, or any other obstruction that leave an opening smaller than the width of a typical passenger car

Potential Impacts:

- Concern regarding impacts to emergency response, street network connectivity, and capacity
- Should consider traffic diversion patterns and associated impacts
- No significant impacts on vehicle speeds beyond the approach to the diverter
- Not appropriate for bus transit routes
- Improved pedestrian and bicycle safety

Lateral Shift

Description:

- Realignment of an otherwise straight street that causes travel lanes to shift in at least one direction
- A chicane is a variation of a lateral shift that shifts alignments more than once

Applications:

- Appropriate for local, collector, or arterial roadways
- Appropriate for one-lane one-way and two-lane two-way streets
- Appropriate on roads with or without dedicated bicycle facilities
- Maximum appropriate speed limit is typically 35 mph
- Appropriate along bus transit routes

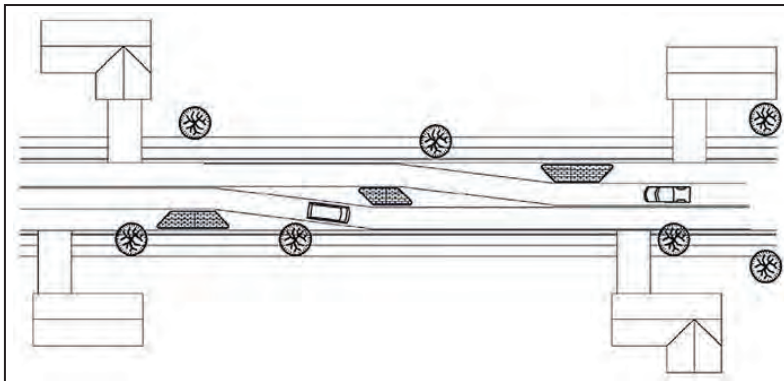

(Source: Delaware Department of Transportation)



(Source: Google Street View)

Design/Installation Issues:

- Typically separates opposing traffic through the shift with the aid of a raised median
- Applicable only to mid-block locations
- Can be installed on either open- or closed-section (i.e. curb and gutter) roads
- Location near streetlights preferred
- May require drainage feature relocation
- Should not require utility relocation

Potential Impacts:

- Without islands, motorists could cross the centerline to drive the straightest path possible
- No impact on access
- May require removal of some on-street parking

- Limited data available on impacts on speed, volume diversions, and crash risk
- Provides opportunities for landscaping
- Can provide locations for pedestrian crosswalks

Median Barrier/Forced Turn Island

Description:

- Raised islands along the centerline of a street and continuing through an intersection that block the left-turn movement from all intersection approaches and the through movement from the cross street; also called median diverter, intersection barrier, intersection diverter, and island diverter
- Raised island that forces a right turn is called a forced turn island

Applications:

- For use on arterial or collector roadways to restrict access to minor roads or local streets and/or to narrow lane widths
- Typically applied only after other measures have failed or been deemed inappropriate/ineffective
- Barriers are made passable for pedestrians and bicyclists
- Often used in sets to make travel to/through neighborhoods more circuitous

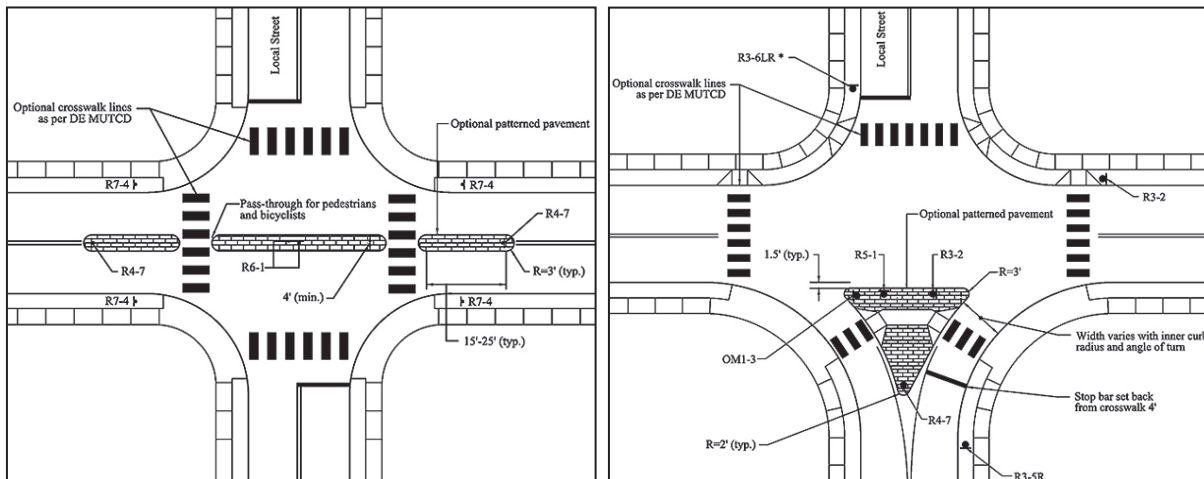

(Source: Delaware Department of Transportation)

Design/Installation Issues:

- Potential legal issues associated with blocking a public street (e.g., business/emergency access)
- Placed on major roads on approaches to and across intersections with minor roads
- Should extend beyond the intersection to discourage improper/illegal turn movements
- Barriers may consist of landscaped islands, mountable features, walls, gates, side-by-

side bollards, or any other obstruction that leave an opening smaller than the width of a passenger car

Potential Impacts:

- May divert traffic volumes to other parallel and/or crossing streets
- May require removal or shortening of on-street parking zones on approaches/departures
- May impact access to properties adjacent to intersection
- No significant impacts on vehicle speeds beyond the approaches to intersection

Median Island

Description:

- Raised island located along the street centerline that narrows the travel lanes at that location
- Also called median diverter, intersection barrier, intersection diverter, and island diverter

Applications:

- For use on arterial, collector, or local roads
- Can often double as a pedestrian/bicycle refuge islands if a cut in the island is provided along a marked crosswalk, bike facility, or shared-use trail crossing
- If placed through an intersection, considered a median barrier

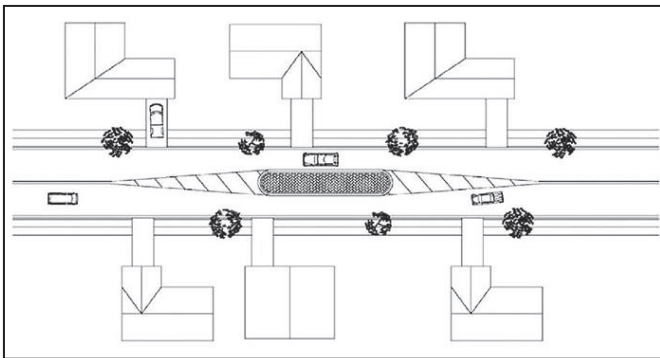

(Source: Delaware DOT)



(Source: James Barrera, Horrocks, NM)

Design/Installation Issues:

- Potential legal issues associated with blocking a public street (e.g., business or emergency access)
- Barriers may consist of landscaped islands, mountable facilities, walls, gates, side-by-side bollards, or any other obstruction that leave an opening smaller than the width of a passenger car
- Can be placed mid-block or on the approach to an intersection
- Typically installed on a closed-section roadway (i.e. curb and gutter)
- Can be applied on roads with or without sidewalks and/or dedicated bicycle facilities
- Maximum appropriate speed limits vary by locale
- Typically, not appropriate near sites that attract large combination trucks

Potential Impacts:

- May impact access to properties adjacent to islands
- No significant impact on vehicle speeds beyond the island
- Little impact on traffic volume diversion
- Safety can be improved without substantially increasing delay
- Shortens pedestrian crossing distances
- Bicyclists may have to share vehicular travel lanes near the island
- May require removal of some on-street parking
- May require relocation of drainage features and utilities

Mini Roundabout

Description:

- Raised islands, placed in unsignalized intersections, around which traffic circulates
- Motorists yield to motorists already in the intersection
- Require drivers to slow to a speed that allows them to comfortably maneuver around them
- Center island of mini roundabout is fully traversable, splitter islands may be fully traversable

Applications:

- Intersections of local and/or collector streets
- One lane each direction entering intersection
- Not typically used at intersections with high volume of large trucks or buses turning left
- Appropriate for low-speed settings

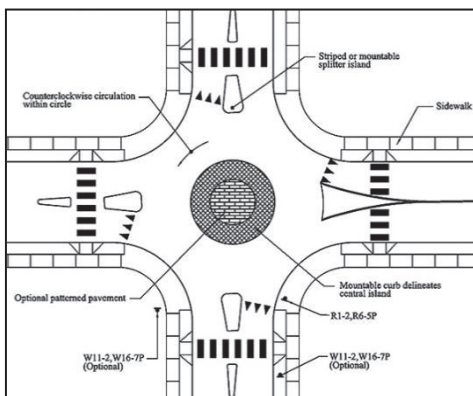

(Source: Delaware DOT)



(Source: Gary Schatz)

Design/Installation:

- See NCHRP Report 672 for design details
- Typically, circular in shape, but may be an oval shape
- Controlled by YIELD signs on all approaches with pedestrian crosswalks, if included, one car-length upstream of YIELD bar
- Preferable for roadway to have urban cross section (i.e., curb and gutter)
- Can be applied to road with on-street parking
- Can be applied to roads both with and without a bicycle facility. Bicycle facilities, if provided, must be separated from the circulatory roadway with physical barriers;

cyclists using the circulatory roadway must merge with vehicles. Bicycle facilities are prohibited in the circulatory roadway to prevent right-hook crashes.

- Key design features are the fastest paths and path alignment.

Potential Impacts:

- Slight speed reduction
- Little diversion of traffic
- Bicycle and motorist will share lanes at intersections because of narrowed roadway
- Large vehicles/buses usually drive over the center island for left turns

On-Street Parking

Description:

- Allocation of paved space to parking
- Narrows road travel lanes and increases side friction to traffic flow
- Can apply on one or both sides of roadway
- Can be either parallel or angled, but parallel is generally preferred for maximized speed reduction

Applications:

- High likelihood of acceptability for nearly all roadway functional classifications and street functions
- More appropriate in urban or suburban settings
- Can be combined with other traffic calming measures
- Can apply alternating sides of street for chicane effect
- Can combine with curb extensions for protected parking, including landscaping for beautification
- Can apply using time-of-day restrictions to maximize throughput during peak periods
- Can be used on one-way or two-way streets
- Preferable to have a closed-section road (i.e. curb and gutter)
- Appropriate along bus transit routes



(Source: PennDOT LTAP)



(Source: Google Earth, Fort Collins, CO)

Design/Installation Issues:

- Appropriate distance needed between travel lane and parking lane
- Impact is directly affected by demand; must have parked vehicles present to be effective

- If used for chicane effect, must verify parking demand to ensure that majority of spaces are occupied when effect is desired most during the day; can use parallel, angled, or combination
- Should not be considered near traffic circles nor roundabouts
- Should not be applied along median island curbs
- For lower-demand locations, can counteract negligible impact with curb extensions or other road- narrowing features

Potential Impacts:

- Can be blocked in by snow during plowing operations; required vehicle removal
- May limit road user visibility and sight distance at driveways/alleys/intersections
- Can put bicyclists at risk of colliding with car doors
- May be impacted if other traffic calming measures are considered or implemented
- Provides buffer between moving vehicles and pedestrian facilities

Realigned Intersection

Description:

- Reconfiguration of an intersection with perpendicular angles to have skewed approaches or travel paths through the intersection
- Also called modified intersection

Applications:

- Appropriate for collector or local streets
- Most applicable at T-intersections
- Can be used where on-street parking exists
- Applicable on one-way and two-way roadways
- Mostly installed on closed-section roads (i.e. curb and gutter)
- Can be applied with and without a dedicated bicycle facility
- Can be applied with or without on-street parking

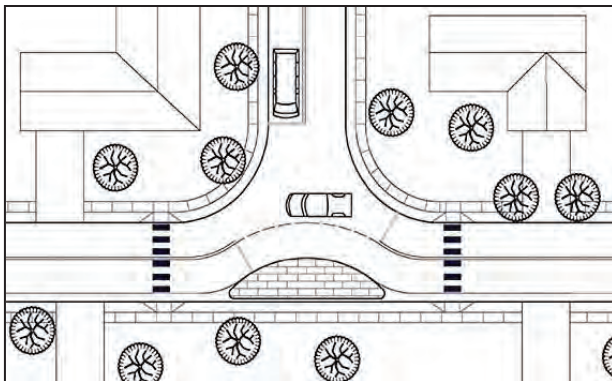

(Source: Delaware Department of Transportation)



(Source: Delaware DOT)

Design/Installation Issues:

- Need to avoid relocating drainage features such as catch basins, concrete channels, valley gutters, inlets, and trench drains
- Bicyclists and motorists may have separate lanes or may share lanes at intersections
- Be cognizant of pedestrian crossing needs (e.g., ADA, wheelchair ramps at T-intersections)
- Default design vehicle SU-30
- Typical maximum speed limit of 25 mph
- May be appropriate for buses if adequate turning radii can be provided

Potential Impacts:

- Limited-to-no impact on access
- Minimal anticipated diversion of traffic
- Can result in speed reductions between 5 and 13 mph within intersection limits
- Provides opportunity for landscaping
- Can improve pedestrian safety
- Consider additional intersection lighting

Road Diet

Description:

- Revision of lane use or widths to result in one travel lane per direction with minimum practical width, with goal of reducing cross-section; common application involves conversion of four-lane Two-way road to three-lane road – two through lanes and center two-way left-turn lane (TWLTL)
- Can also involve narrowing of existing travel lanes
- Alternate cross-section uses can include dedicated bicycle facilities, left-turn lanes, on-street parking, raised medians, pedestrian refuge islands, sidewalks, etc.

Applications:

- High likelihood of acceptability for nearly all roadway functional classifications
- Can be applied in urban, suburban, or rural settings
- Appropriate for most common urban speed limits
- Can be applied at/near intersections or along road segments
- Appropriate along bus routes



(Source: Chuck Huffine, Phoenix, AZ)



(Source: Chuck Huffine, Denver, CO)

Design/Installation Issues:

- Must consider transitions from adjacent roadway sections and through intersections
- AADT can be considered but is not the primary volume factor that needs to be evaluated

Potential Impacts:

- Usually reduces number of available travel lanes – impacts demand that can be accommodated; typical acceptable threshold of 1000 vehicles per direction during

peak hour

- Reduction of through lanes tends to reduce speeds
- Can improve pedestrian crossing ease and safety
- Can improve bicycle accessibility if travel lanes can be used for shoulders/bike lanes instead

Roundabout

Description:

- Raised islands placed in unsignalized intersections around which traffic circulates
- Approaching motorists yield to motorists already in the intersection
- Requires drivers to slow to a speed that allows them to comfortably maneuver around them
- Different from traffic circles or mini-roundabouts; possible substitute for traffic signal control

Applications:

- Intersections of arterial and/or collector streets
- One or more entering lanes
- Can be used at intersections with high volumes of large trucks and buses, depending on design

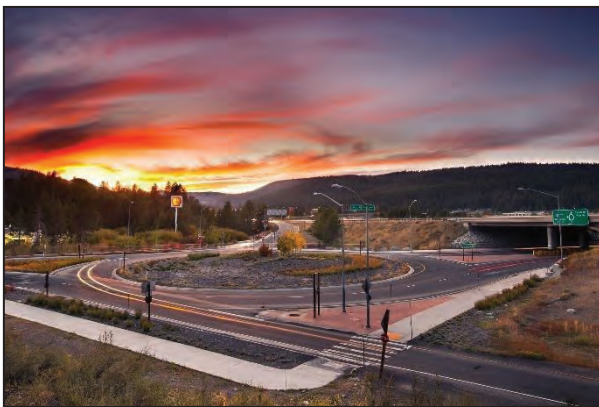

(Source: Grant Kaye)



(Source: PennDOT LTAP)

Design/Installation:

- See NCHRP Report 672 for design details
- Design vehicle is determined specifically for each site ranging from emergency vehicles to over size/overweight vehicles
- Typically circular in shape but may be an oval shape
- Key physical elements are center islands, truck aprons, and splitter islands
- Controlled by YIELD signs on all approaches with pedestrian crosswalks, if included, one car-length upstream of YIELD bar
- Key design features include: fastest paths, swept paths, and path alignment
- Large vehicles circulating around the center island for all movements may traverse the apron

- Landscaping needs to be designed to allow adequate sight distance per NCHRP 672
- Preferable to have a closed-section road (i.e. curb and gutter)
- Bicycle facilities, if provided, must be separate from the circulatory roadway with physical barriers; cyclists using the circulatory roadway must merge with vehicles. Bicycle facilities are prohibited in the circulatory roadway to prevent right-hook crashes.

Potential Impacts:

- Limited impact on access, except for access points immediately adjacent to intersection
- Limited impact on roadways with on-street parking
- May draw additional traffic but with reduced delays and queues

Speed Cushion

Description:

- Two or more raised areas placed laterally across a roadway with gaps between raised areas
- Height and length similar to a speed hump; spacing of gaps allow emergency vehicles to pass through at higher speeds
- Often placed in a series (typically spaced 260 to 500 feet apart)
- Sometimes called speed lump, speed slot, and speed pillow

Applications:

- Appropriate on local and collector streets
- Appropriate at mid-block locations only
- Not appropriate on grades greater than 8 percent



(Source: James Barrera, Horrocks, NM)

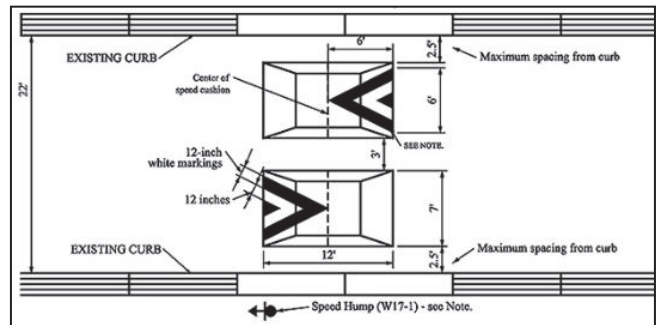

(Source: Delaware Department of Transportation)

Design/Installation Issues:

- Two or more cushions at each location
- Typically 12 to 14 feet in length and 7 feet in width
- Cushion heights range between 3 and 4 inches, with trend toward 3 - 3 1/2 inches maximum
- Speed cushion shapes include parabolic, circular, and sinusoidal
- Material can be asphalt or rubber
- Often have associated signing (advance-warning sign before first cushion at each cushion)
- Typically have pavement markings (zigzag, shark's tooth, chevron, zebra)
- Some have speed advisories

Potential Impacts:

- Limited-to-no impact on non-emergency access
- Speeds determined by height and spacing; speed reductions between cushions have been observed averaging 20 and 25 percent
- Speeds typically increase by 0.5 mph midway between cushions for each 100 feet of separation
- Studies indicate that average traffic volumes have reduced by 20 percent depending on alternative routes available
- Average collision rates have been reduced by 13 percent on treated streets

Speed Hump

Description:

- Rounded (vertically along travel path) raised areas of pavement typically 12 to 14 feet in length
- Often placed in a series (typically spaced 260 to 500 feet apart)
- Sometimes called road humps or undulations

Applications:

- Appropriate for residential local streets and residential/neighborhood collectors
- Not typically used on major roads, bus routes, or primary emergency response routes
- Not appropriate for roads with 85th-percentile speeds of 45 mph or more
- Appropriate for mid-block placement, not at intersections
- Not recommended on grades greater than 8 percent
- Work well in combination with curb extensions
- Can be used on a one-lane one-way or two-lane two-way street



(Source: City of Boulder, Colorado)



(Source: PennDOT LTAP)

Design/Installation Issues:

- ITE recommended practice - "Guidelines for the Design and Application of Speed Humps"
- Typically, 12 to 14 feet in length; other lengths (10, 22, and 30 feet) reported in practice in U.S.
- Speed hump shapes include parabolic, circular, and sinusoidal
- Typically spaced no more than 500 feet apart to achieve an 85th percentile speed between 25 and 35 mph
- Hump heights range between 3 and 4 inches, with trend toward 3 - 3 ½ inches maximum
- Often have associated signing (advance warning sign before first hump in series at

each hump)

- Typically have pavement markings (zigzag, shark's tooth, chevron, zebra)
- Taper edge near curb to allow gap for drainage
- Some have speed advisories
- Need to design for drainage, without encouraging means for motorists to go around a hump

Potential Impacts:

- No impact on non-emergency access
- Average speeds between humps reduced between 20 and 25 percent
- Speeds typically increase approximately 0.5 to 1 mph midway between humps for each 100 feet Beyond the 200-foot approach and exit of consecutive humps
- Traffic volumes diversion estimated around 20 percent; average crash rates reduced by 13 percent

Speed Table/Raised Crosswalks

Description:

- Long, raised speed humps with a flat section in the middle and ramps on the ends; sometimes constructed with brick or other textured materials on the flat section
- If placed at a pedestrian crossing, it is referred to as a raised crosswalk
- If placed only in one direction on a road, it is called an offset speed table

Applications:

- Appropriate for local and collector streets; mid-block or at intersections, with/without crosswalks
- Can be used on a one-lane one-way or two-lane two-way street
- Not appropriate for roads with 85th percentile speeds of 45 mph or more
- Typically, long enough for the entire wheelbase of a passenger car to rest on top or within limits of ramps
- Work well in combination with textured crosswalks, curb extensions, and curb radius reductions
- Can be applied both with and without sidewalks or dedicated bicycle facilities
- Typically installed along closed-section roads (i.e. curb and gutter) but feasible on open section

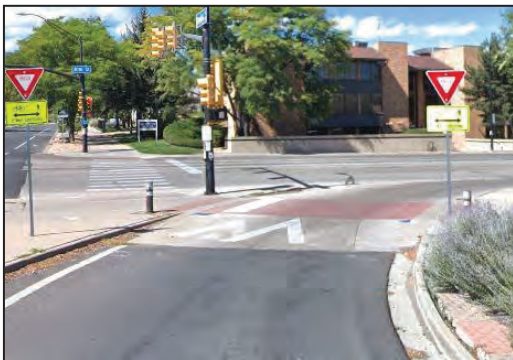

(Source: Google Maps, Boulder, Colorado)

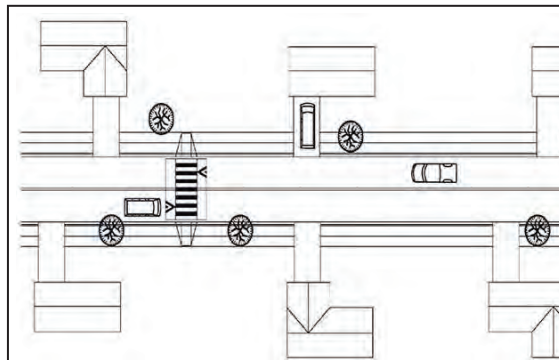

(Source: Delaware DOT)

Design/Installation Issues:

- ITE recommended practice – “Guidelines for the Design and Application of Speed Humps”
- Most common height is between 3 and 4 inches (reported as high as 6 inches)
- Ramps are typically 6 feet long (reported up to 10 feet long) and are either parabolic or linear
- Careful design is needed for drainage
- Posted speed typically 30 mph or less

Potential Impacts:

- No impact on non-emergency access
- Speeds reductions typically less than for speed humps (typical traversing speeds between 25 and 27 miles per hour)
- Speeds typically decline approximately 0.5 to 1 mph midway between tables for each 100 feet beyond the 200-foot approach and exit points of consecutive speed tables
- Average traffic volumes diversions of 20 percent when a series of speed tables are implemented
- Average crash rate reduction of 45 percent on treated streets
- Increase pedestrian visibility and likelihood of driver yield compliance
- Generally, not appropriate for bus rapid transit routes

Traffic Circle

Description:

- Raised islands placed in unsignalized intersections around which traffic circulates
- Approaching motorists yield to motorists already in the intersection
- Require drivers to slow to a speed that allows them to comfortably maneuver around them
- Approaches not designed to modern roundabout principals - no deflection

Applications:

- Appropriate at intersections of local streets
- One lane each direction entering intersection
- Not typically used at intersections with high volumes of large trucks or buses turning left
- appropriate for both one-way and two-way streets in urban and suburban settings



(Source: Scott Batson)



(Source: Scott Batson)

Design/Installation Issues:

- Typically, circular in shape but may be an oval shape
- Usually have landscaped center islands
- Recommend YIELD signs on all approaches
- Preferable for roadways to be closed section (i.e. curb and gutter)
- Can be applied to roads with on-street parking
- Can be applied to roads both with and without dedicated bicycle facilities; bike lanes not striped in circulatory roadway
- Key design features include offset distance (distance between projection of street

curb and center island), lane width of circulatory roadway, circle diameter, and height of mountable apron for large vehicles

Potential Impacts:

- Minimal anticipated traffic diversion
- Bicyclist and motorists will share lanes at intersections because of narrowed roadway
- Large vehicles/buses usually not able to circulate around center island for left turns
- Landscaping needs to be designed to allow adequate sight distance, per AASHTO
- Minimize routing of vehicles through unmarked crosswalks on side-streets
- May require additional street lighting

SECTION V - FORMS

CITY OF SOCORRO
NEIGHBORHOOD TRAFFIC MANAGEMENT PLAN

RESTAURANT

SECTION V – FORM

**NEIGHBORHOOD TRAFFIC CALMING REQUEST
CITY OF SOCORRO — NTMP APPLICATION FORM**

Part A

Date: _____

On this date, we, the residents of, request that the City of Socorro’s Planning and Zoning Department initiate a NTMP Study in our neighborhood to address the following concern(s):

- Safety
- Speeding
- Excess Traffic
- Cut-Through Traffic
- Bicycle or Pedestrian
- Commercial Vehicle Restriction
- Parking
- Noise
- Other (Please describe:) _____

Description of neighborhood conditions or recent changes in traffic, leading to this application:

Part B

We understand that the NTMP process involves active participation of our community and that the decision-making process may require us to set and attend neighborhood meetings, further petition campaigns, and coordinate with the Planning and Zoning Department on components of the Study. We also understand that initiating a NTMP Study does not guarantee implementation of traffic calming devices or policies, which are dependent on both the findings of the study and available fiscal resources.

Part C

All persons signing this official request certify that they reside in the neighborhood referenced in Part A above, and agree with the identified concern(s) checked in Part A. All persons signing this official request also agree that the designated contact person(s) below will represent the neighborhood as facilitator(s) between the neighborhood residents and the City of Socorro’s Planning and Zoning Department for the purposes of this NTMP Study.

Sign and submit to the City of Socorro c/o City Clerk (124 S. Horizon Socorro, TX 79927 or cityclerk@ci.socorro.tx.us)

Designated Neighborhood Contact(s)

Name: _____ Address: _____

Telephone: _____ Email: _____

Supporting Neighborhood Resident Applicants

Name: _____ Address: _____

Telephone: _____ Email: _____

Name: _____ Address: _____

Telephone: _____ Email: _____

**NEIGHBORHOOD TRAFFIC CALMING REQUEST
CITY OF SOCORRO — NTMP PETITION FORM**

Date: _____

Representatives from the neighborhood, on requested initiation of a NTMP Study. Based on available data, the households and properties identified in the attached Exhibit 1, **to be provided by applicant**, are considered to be in the affected area. An initial assessment of available data has been conducted, and to continue processing the application neighborhood support is required. Two-thirds of the shown households/properties on Exhibit 1 must agree with the application and sign the petition below. The completed petition should be submitted to the City of Socorro c/o City Clerk (124 S. Horizon Socorro, TX 79927 or cityclerk@ci.socorro.tx.us).

Section II (ONLY ONE SIGNATURE PER ADDRESS)

Name(print): _____ Address: _____ Telephone: _____
Email: _____ Signature: _____

Name(print): _____ Address: _____ Telephone: _____
Email: _____ Signature: _____

Name(print): _____ Address: _____ Telephone: _____
Email: _____ Signature: _____

Name(print): _____ Address: _____ Telephone: _____
Email: _____ Signature: _____

Name(print): _____ Address: _____ Telephone: _____
Email: _____ Signature: _____

Name(print): _____ Address: _____ Telephone: _____
Email: _____ Signature: _____

Name(print): _____ Address: _____ Telephone: _____
Email: _____ Signature: _____

Name(print): _____ Address: _____ Telephone: _____
Email: _____ Signature: _____

Name(print): _____ Address: _____ Telephone: _____
Email: _____ Signature: _____

Name(print): _____ Address: _____ Telephone: _____
Email: _____ Signature: _____

Name(print): _____ Address: _____ Telephone: _____
Email: _____ Signature: _____

Name(print): _____ Address: _____ Telephone: _____
Email: _____ Signature: _____

Name(print): _____ Address: _____ Telephone: _____
Email: _____ Signature: _____

Name(print): _____ Address: _____ Telephone: _____
Email: _____ Signature: _____

Date: _____

Section II (ONLY ONE SIGNATURE PER ADDRESS)

Name(print): _____ Address: _____ Telephone: _____
Email: _____ Signature: _____

Name(print): _____ Address: _____ Telephone: _____
Email: _____ Signature: _____

Name(print): _____ Address: _____ Telephone: _____
Email: _____ Signature: _____

Name(print): _____ Address: _____ Telephone: _____
Email: _____ Signature: _____

Name(print): _____ Address: _____ Telephone: _____
Email: _____ Signature: _____

Name(print): _____ Address: _____ Telephone: _____
Email: _____ Signature: _____

Name(print): _____ Address: _____ Telephone: _____
Email: _____ Signature: _____

Name(print): _____ Address: _____ Telephone: _____
Email: _____ Signature: _____

Name(print): _____ Address: _____ Telephone: _____
Email: _____ Signature: _____

Name(print): _____ Address: _____ Telephone: _____
Email: _____ Signature: _____

Name(print): _____ Address: _____ Telephone: _____
Email: _____ Signature: _____

Name(print): _____ Address: _____ Telephone: _____
Email: _____ Signature: _____

Name(print): _____ Address: _____ Telephone: _____
Email: _____ Signature: _____

Name(print): _____ Address: _____ Telephone: _____
Email: _____ Signature: _____

Name(print): _____ Address: _____ Telephone: _____
Email: _____ Signature: _____

Name(print): _____ Address: _____ Telephone: _____
Email: _____ Signature: _____

Name(print): _____ Address: _____ Telephone: _____
Email: _____ Signature: _____

REFERENCES

2009 Manual on Uniform Traffic Control Devices (MUTCD). FHWA. 2012

2011 Texas Manual on Uniform Traffic Control Devices (TMUTCD) - Revision 2. TxDOT. 2014

ITE/FHWA Traffic Calming EPrimer. FHWA. 2017

Neighborhood Traffic Management Program. City of El Paso, Texas. 2018

Neighborhood Traffic Management Program. City of Lubbock, Texas. 2015

Neighborhood Traffic Management Program. City of Tucson, Arizona. 2018

ITEM 14

Elia Garcia
Mayor
Rene Rodriguez
At Large
Cesar Nevarez
District 1 / Mayor Pro Tem



Ralph Duran
District 2
Victor Perez
District 3
Yvonne Colon-Villalobos
District 4
Adriana Rodarte
City Manager

October 30, 2020

TO: MAYOR AND CITY COUNCIL MEMBERS

FROM: City Manager, Adriana Rodarte

SUBJECT: Discussion and action regarding Texas Gas Service Elizabeth O'hara and Jasmine King-Bush regarding Energy Efficiency Program.

SUMMARY

Please see attached presentation

STATEMENT OF THE ISSUE

FINANCIAL IMPACT

Account Code (GF/GL/Dept):

Funding Source:

Amount:

Quotes (Name/Commodity/Price) N/A

Co-op Agreement (Name/Contract#) N/A

ALTERNATIVE

N/A

STAFF RECOMMENDATION

N/A

REQUIRED AUTHORIZATION

1. City Manager _____ Date _____
2. CFO _____ Date _____
3. Attorney _____ Date _____



Texas Gas Service®

A Division of ONE Gas

West Texas Energy Efficiency Program Proposal

Jasmine King-Bush – Energy Efficiency Program Supervisor





Texas Gas Service Energy Efficiency Program

Proposed Program Offering

Texas Gas Service has had an energy efficiency program serving 230,000+ customers in the Central Texas Service Area for over 20 years.

Throughout this time we have provided education about smart and efficient use of natural gas while incentivizing customers to join the effort to conserve energy resources.

The Rio Grande Valley program is currently in its 4th year and we have received a very positive response from the customers, builders and community groups which we serve. We are on track to exhaust the program budget by the close of the year.

This proposal is a result of conversations held with members of city leadership and demonstrates our desire to partner together to decrease energy usage and improve sustainability in El Paso.

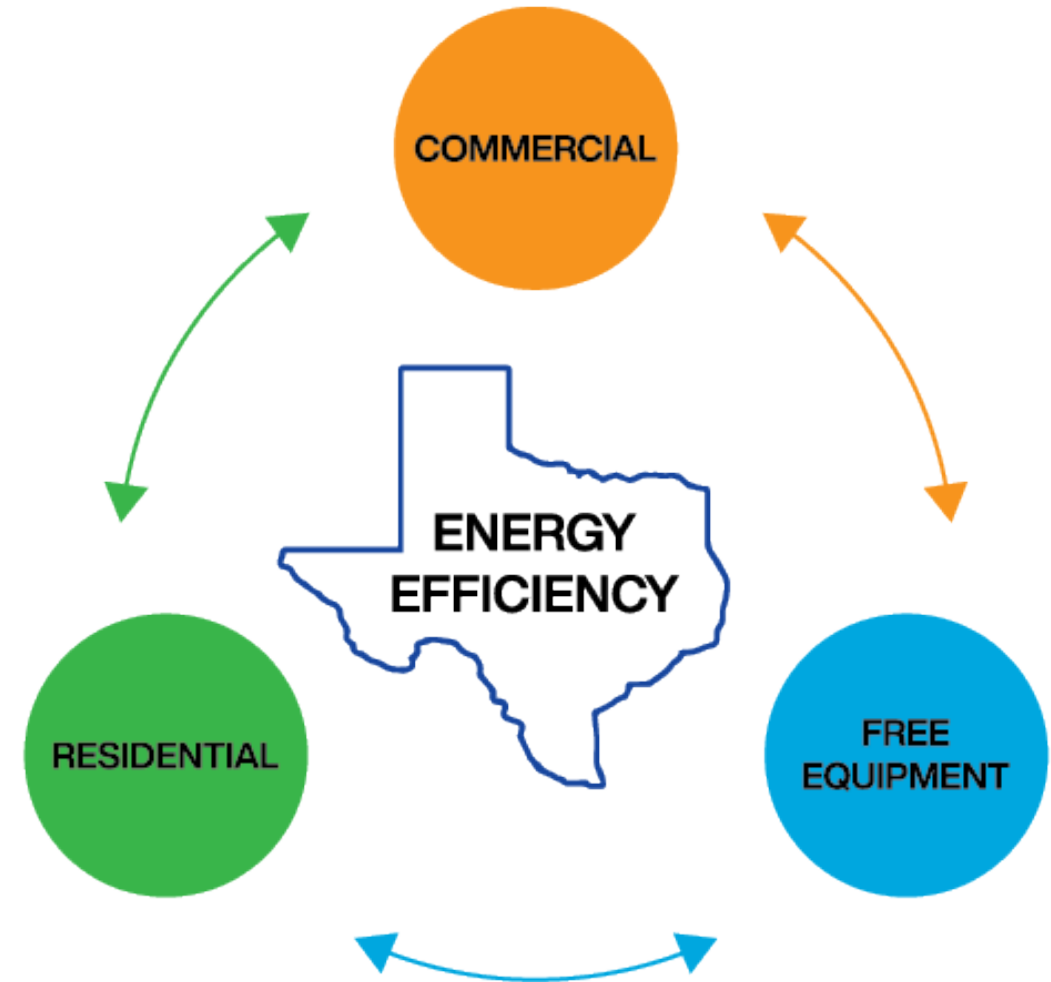

Texas Gas Service Energy Efficiency Program

Proposed Program Offering

We would like to offer the program in the following cities as cited in the filing packet:

- Anthony
- Clint
- El Paso
- Horizon City
- San Elizario
- Socorro
- Vinton

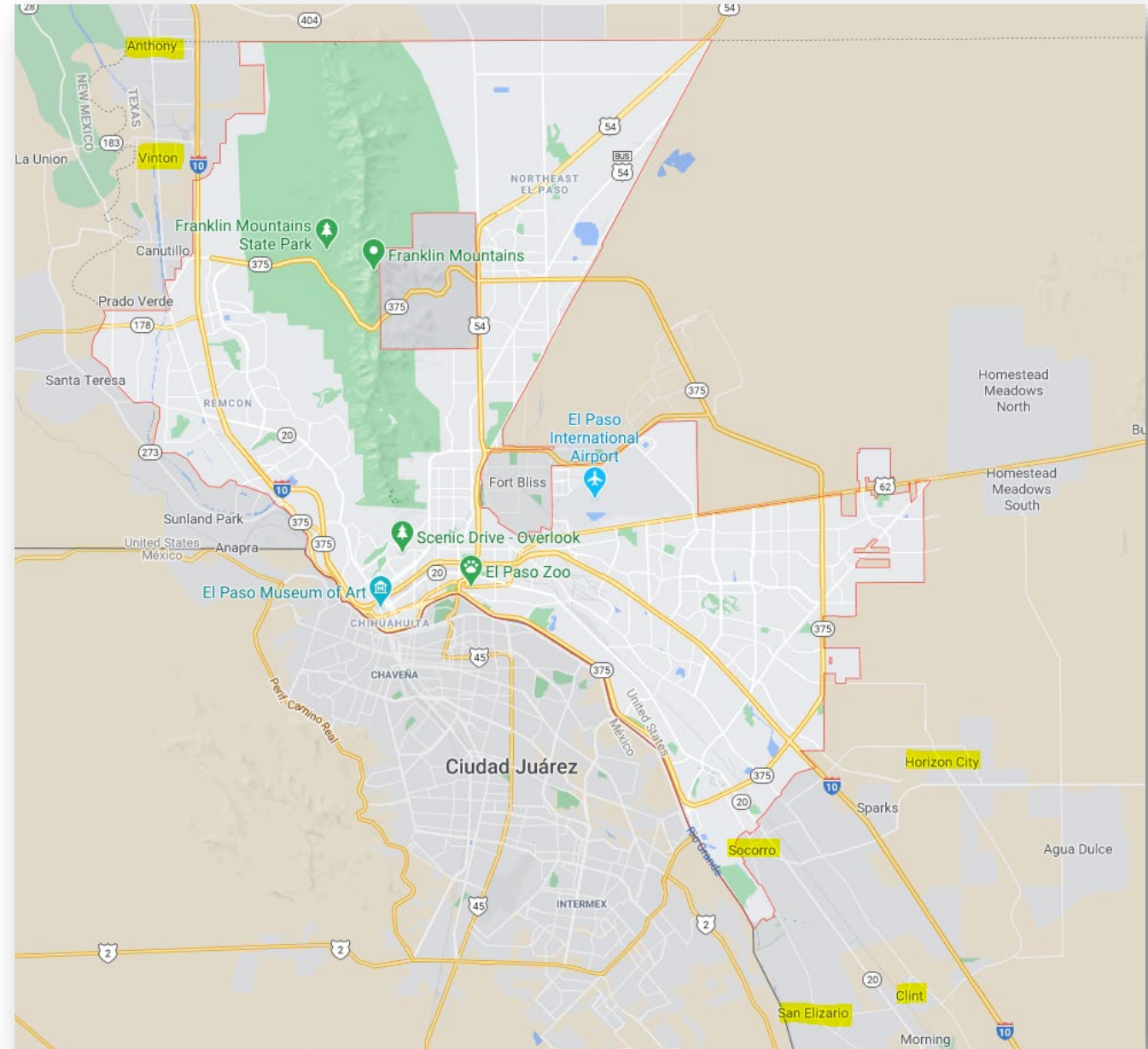

Texas Gas Service Energy Efficiency Program

Residential Program Rebates

- **Residential Retrofit and New Construction**
 - **Dryer Programs** - stubs and qualifying appliances
 - **Heating Programs** - furnace tune-ups and qualifying appliances
 - **Range Programs** - purchase and/or installation of qualifying cooktops and ovens
 - **WiFi Thermostat**
 - **Water Heating Programs** - qualifying HE and tankless natural gas water heaters

Texas Gas Service Energy Efficiency Program

Residential Water Conservation Kits

- WaterSense conservation kits include two bathroom faucet aerators, a kitchen swivel faucet aerator and one low-flow showerhead.
- Available at no cost upon request to all Texas Gas Service customers regardless of occupancy status (renters or homeowners) in the included cities, while supplies last.
- Installation and use of water conservation kits provide both a water and natural gas energy savings.
 - Households that use low-flow showerheads can see a savings of up to **2,900 gallons** of water per year.
 - Bathroom sinks that have aerators installed can provide a **savings of up to 700 gallons** of water per year.



Texas Gas Service Energy Efficiency Program

Low-Income Free Equipment Program

- Local contractor partners replace or repair old, inefficient, broken or unsafe natural gas equipment.
- Facilitated through partnerships with local referral agencies and advocacy programs.
- Qualifying low-income, mobility-challenged and elderly customers are eligible.



Texas Gas Service Energy Efficiency Program

Commercial Program

- **Direct Install Programs**
 - Water Efficiency Measures
 - Weatherstripping
- **Water Heating Programs** for qualifying equipment and systems
- **CNG Vehicle Programs** for commercial refueling units or new CNG vehicle conversions
- **Food Service Equipment Programs** for eligible ENERGY STAR® appliances
- **Dryer Programs** for qualifying natural gas dryers



DON'T LET YOUR MONEY GO DOWN THE DRAIN.

If you're a Texas Gas Service Commercial customer, our technicians can install energy- and water-saving upgrades **at no cost to you** to help you save money and energy.

 <p>Low-flow aerators reduce water use by approximately 50 percent.</p>	 <p>Energy-efficient showerheads can save over \$100/year.</p>
 <p>Pre-rinse spray valves can save up to \$200/year for each valve installed.</p>	 <p>Weatherstripping can save over \$100/year per door.</p>

These devices save energy by reducing the need to heat water, so your business or facility must use a natural gas water heater to be eligible.

GET FREE UPGRADES FOR YOUR BUSINESS TODAY.

For more information about this and other Commercial Rate rebate programs (see reverse), email EnergyEfficiency@TexasGasService.com or call 512-370-8256.

 **Texas Gas Service.**
A Division of ONE Gas

Texas Gas Service Energy Efficiency Program

Educational Outreach

- Behavioral Education Efforts
 - Web-based Energy Calculators
 - Tips for Efficient Living
- Community Outreach/Community Events
- Social Media Engagement
- Retailer Partnerships
- Bill Inserts geared towards raising awareness of programs and additional efficiency rebate opportunities
- Energy Efficiency Newsletter

Make your *time better spent* with these

5 Summer Energy-Saving Tips

- 

1 Run dryers, dishwashers and other large appliances after dark so your air conditioner isn't fighting too many battles at once.
- 

2 Keep cool air in and hot air out by sealing doors and windows.
- 

3 Check all of your vents to make sure they're open, free of dust and directing air toward the center of the room.
- 

4 Replace your shower head with a low-flow model. Doing so reduces both your water and energy use from your water heater.
- 

5 Upgrade to high-efficiency natural gas appliances to save time, energy and money!

 **Texas Gas Service.**
A Division of ONE Gas

Learn more about our natural gas appliance rebates at [TexasGasService.com/rebates](https://www.texasgasservice.com/rebates).

Texas Gas Service Energy Efficiency Program

Proposed Budget (\$) & Projected Participation (%)

The proposed budget of \$2,275,000 would be funded by a monthly **fixed charge** of **\$0.73 per month** for our approximately 220K+ residential customers and a **volumetric charge** of **\$0.0067/CCF** for our commercial customers.

	BUDGET	% OF BUDGET
Residential	\$ 1,100,000	48%
Commercial	\$ 225,000	10%
Low-Income	\$ 300,000	14%
Education/Outreach	\$ 325,000	14%
Administration	\$ 325,000	14%
TOTAL	\$ 2,275,000	100%

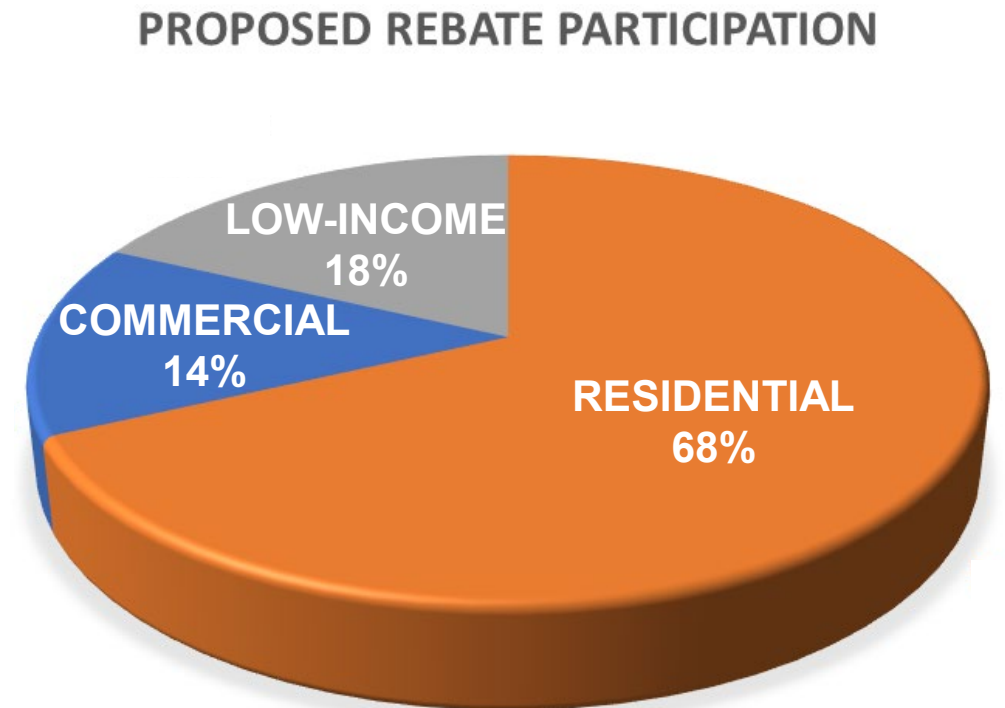

Texas Gas Service Energy Efficiency Program

2019 Achievements

Through the Central Texas and Rio Grande Valley Energy Efficiency programs:

- **\$2.4 million was returned to customers** through energy efficiency rebates and incentives
- More than **240 free new natural gas appliances** installed for low-income families
- **8,000+** residential rebates issued
- **2,689** residential water conservation kits distributed
- Lifetime emissions reduced by more than **78 million pounds**
- More than **140+ million gallons** of expected water savings.
- Customers receive **\$1.35 in benefits** for every \$1 spent on new natural gas appliances/systems

Commercial	\$ 283,595
Residential	\$ 1,800,833
Low-Income	\$ 356,872
REBATE TOTALS	\$ 2,441,300

Texas Gas Service Energy Efficiency Program

Program Benefits

- Behavioral education, high-efficiency appliances and energy-saving measures reduce natural gas consumption and customer bills.
- Provides low-income assistance.
- Use of efficient natural gas appliances reduces load on electric grid and may help reduce effects of grid strain during summer peaks.
- Natural gas and water conservation and the promotion of clean, efficient energy use supports Office of Resilience and Sustainability goals.

Questions?

Jasmine King-Bush
Energy Efficiency Program Supervisor
Jasmine.King-Bush@ONEGas.com



Elia Garcia
Mayor

Rene Rodriguez
At-Large/Mayor ProTem

Maria Reyes
District 1



Ralph Duran
District 2

Victor Perez
District 3

Yvonne Colon-Villalobos
District 4

Adriana Rodarte
City Manager

RESOLUTION 628

RESOLUTION CANVASSING RETURNS OF THE GENERAL ELECTION HELD IN THE CITY OF SOCORRO, TEXAS, ON TUESDAY, THE 3rd DAY OF NOVEMBER, 2020, FOR THE PURPOSE OF ELECTING THE CITY OF SOCORRO MAYOR AND AT-LARGE AND DISTRICT NO. 4 REPRESENTATIVES AND PROPOSITIONS 1 THROUGH 28 REGARDING AMENDMENTS TO THE SOCORRO CITY CHARTER

WHEREAS, the City Council of the City of Socorro ordered a general election to be held on November 3, 2020, for the purpose of electing the City of Socorro Mayor and At- Large and District No. 4 Representatives; and

WHEREAS, the City Council of the City of Socorro adopted an Ordinance calling for an election for approval or rejection of 28 Propositions regarding Amendments to the Socorro City Charter to be held on the 3rd of November, 2020; and

WHEREAS, the election officers who held said election have duly made returns of the results thereof and said returns have been duly delivered to the City Council.

NOW, THEREFORE, BE IT RESOLVED BY THE CITY COUNCIL OF THE CITY OF SOCORRO, TEXAS:

1. That the City Council officially finds and determines that notice of said general election and charter amendment election was duly given, that proper election officers were duly appointed prior to said election, that said election was duly held, that due returns of the results of said election have been duly made and delivered, that the general election charter amendment election returns have properly been made out and duly certified by the officers of said general election and charter amendment election in the different voting precincts of the City, and that the City Council has duly canvassed said returns, all in accordance with law and the resolution and amendments thereto calling said election.

2. That the City Council officially finds and determines that the following votes were cast at said general election for the following offices by the resident, qualified electors of said City, who voted at the election:

MAYOR RESULTS

Ivy Avalos	3,258 votes	(43.11%)
Jesus S. "Chuy" Hernandez	2,501 votes	(33.10%)
Jesus Alejandro Ruiz	1,365 votes	(18.06%)
Al Gutierrez	433 votes	(5.73%)

CITY OF SOCORRO, AT LARGE

Jesse Montelongo	2,133 votes	(29.27%)
Ruben Reyes	1,951 votes	(26.77%)
Rene Rodriguez	1,881 votes	(25.81%)
Ernest Gomez, Jr.	1,322 votes	(18.14%)

DISTRICT NO. 4 REPRESENTATIVE

Yvonne Colon-Villalobos	751 votes	(36.98%)
Jaime Huereca	512 votes	(25.21%)
Enrique Cisneros	450 votes	(22.16%)

3. That for the offices of Mayor, At-Large Representative and District No. 4 Representative, no candidate received more than a 50% majority of all votes cast for such office, and accordingly no one for said offices is declared elected and a runoff election is to be called by the City Council in accordance with the Texas Election Code; and that the number of votes cast for each person who was a candidate for such office, according to the returns, is shown in paragraph 2 hereof.

4. That the City Council officially finds and determines that the following votes were cast at said charter election for the following 28 Propositions regarding amendments to the City of Socorro City Charter:

CITY OF SOCORRO PROPOSITION 1

For	6,019 votes	(79.36%)
Against	1,565 votes	(20.64%)

CITY OF SOCORRO PROPOSITION 2

For	5,357 votes	(71.37%)
Against	2,149 votes	(28.63%)

CITY OF SOCORRO PROPOSITION 3

For	5,832 votes	(72.47%)
Against	2,045 votes	(27.53%)

CITY OF SOCORRO PROPOSITION 4

For	4,240 votes	(56.83%)
Against	3,221 votes	(43.17%)

CITY OF SOCORRO PROPOSITION 5

For	3,826 votes	(51.65%)
Against	3,581 votes	(48.35%)

CITY OF SOCORRO PROPOSITION 6

For	4,988 votes	(67.72%)
Against	2,378 votes	(32.28%)

CITY OF SOCORRO PROPOSITION 7

For	5,901 votes	(80.13%)
Against	1,463 votes	(19.87%)

CITY OF SOCORRO PROPOSITION 8

For	4,587 votes	(62.60%)
Against	2,740 votes	(37.40%)

CITY OF SOCORRO PROPOSITION 9

For	5,253 votes	(75.75%)
Against	1,682 votes	(24.25%)

CITY OF SOCORRO PROPOSITION 10

For	6,099 votes	(83.64%)
Against	1,193 votes	(16.36%)

CITY OF SOCORRO PROPOSITION 11

For	5,731 votes	(78.78%)
Against	1,544 votes	(21.22%)

CITY OF SOCORRO PROPOSITION 12

For	5,355 votes	(73.34%)
Against	1,947 votes	(26.66%)

CITY OF SOCORRO PROPOSITION 13

For	3,011 votes	(42.76%)
Against	4,030 votes	(57.24%)

CITY OF SOCORRO PROPOSITION 14

For	5,405 votes	(74.13%)
Against	1,886 votes	(25.87%)

CITY OF SOCORRO PROPOSITION 15

For	5,358 votes	(74.77%)
Against	1,808 votes	(25.23%)

CITY OF SOCORRO PROPOSITION 16

For	5,835 votes	(80.96%)
Against	1,372 votes	(19.04%)

CITY OF SOCORRO PROPOSITION 17

For	5,566 votes	(77.74%)
Against	1,594 votes	(22.26%)

CITY OF SOCORRO PROPOSITION 18

For	4,776 votes	(66.69%)
Against	2,386 votes	(33.31%)

CITY OF SOCORRO PROPOSITION 19

For	5,585 votes	(78.35%)
Against	1,543 votes	(21.65%)

CITY OF SOCORRO PROPOSITION 20

For	5,852 votes	(82.75%)
Against	1,220 votes	(17.25%)

CITY OF SOCORRO PROPOSITION 21

For	5,762 votes	(81.33%)
Against	1,323 votes	(18.67%)

CITY OF SOCORRO PROPOSITION 22

For	4,653 votes	(65.09%)
Against	2,496 votes	(34.91%)

CITY OF SOCORRO PROPOSITION 23

For	5,690 votes	(80.08%)
Against	1,415 votes	(19.92%)

CITY OF SOCORRO PROPOSITION 24

For	5,692 votes	(80.52%)
Against	1,377 votes	(19.48%)

CITY OF SOCORRO PROPOSITION 25

For	5,823 votes	(81.55%)
Against	1,317 votes	(18.45%)

CITY OF SOCORRO PROPOSITION 26

For	5,282 votes	(74.28%)
Against	1,829 votes	(25.72%)

CITY OF SOCORRO PROPOSITION 27

For	5,708 votes	(83.55%)
Against	1,124 votes	(16.45%)

CITY OF SOCORRO PROPOSITION 28

For	6,126 votes	(86.27%)
Against	975 votes	(13.73%)

5. That on file in the City Clerk's Office and made a part hereof by reference are copies of the mechanical precinct tabulations of the votes cast at the general election held on November 3, 2020, to elect the offices of Mayor, At-Large Representative and

District No. 4 Representative, showing the number of votes cast in each precinct for each candidate.

6. That on file in the City Clerk's Office and made a part hereof by reference are copies of the mechanical precinct tabulations of the votes cast at the charter amendment election held on November 3, 2020, to approve or reject 28 Propositions regarding Amendments to the City Charter of the City of Socorro, Texas, showing the number of votes casting each Precinct for each Proposition.

7. That this Resolution is adopted subject to the right of any candidate to contest such general election as provided by law.

8. That this Resolution was acted upon in accordance with the law by the Presiding Officer and City Council and was deemed that upon passage, it shall take effect immediately.

SO RESOLVED in open meeting by vote of the City Council this 12th day of November, 2020.

Elia Garcia, Mayor

ATTEST:

Olivia Navarro, City Clerk

APPROVED AS TO FORM AND LEGALITY:

James A. Martinez, City Attorney

ADOPTED and EFFECTIVE: November 12, 2020.

**AN ORDER SCHEDULING A RUNOFF ELECTION TO BE HELD IN
THE CITY OF SOCORRO, TEXAS, ON THURSDAY, THE 12th DAY
OF DECEMBER 2020, FOR THE PURPOSE OF ELECTING
THE CITY OF SOCORRO MAYOR AND AT-LARGE AND DISTRICT NO. 4
REPRESENTATIVES**

BE IT ORDERED BY THE CITY COUNCIL OF THE CITY OF SOCORRO, TEXAS:

**SECTION 1.
RUNOFF ELECTION ORDERED.**

As no candidate for the City of Socorro Mayor and At-Large and District No. 4 Representatives received a majority of the votes cast for said positions, the City Council hereby orders a runoff election for such positions, between the following two candidates receiving the highest number of votes for said positions:

MAYOR RESULTS

Ivy Avalos	3,258 votes	(43.11%)
Jesus S. "Chuy" Hernandez	1,951 votes	(33.10%)

AT LARGE REPRESENTATIVE

Jesse Montelongo	2,133 votes	(29.27%)
Ruben Reyes	1,951 votes	(26.77%)

DISTRICT NO. 4 REPRESENTATIVE

Yvonne Colon-Villalobos	751 votes	(36.98%)
Jaime Huereca	512 votes	(25.21%)

In accordance with the Constitution and laws of the State of Texas, the City Council hereby orders that the runoff election be held on December 12, 2020, as authorized by section 2.021 of the Texas Election Code, at which qualified voters residing within the City of Socorro may vote for the purpose of electing the City of Socorro Mayor and At-Large and District No. 4 Representatives.

The runoff election shall be conducted by contract with the El Paso County Elections Department. The City Manager is authorized to approve and accept any agreements with the El Paso County Elections Department and to do all other things required for conduct of this Election.

**SECTION 2.
BALLOT.**

The Socorro City Clerk shall coordinate procedures with the El Paso County Elections Department to ensure that ballots are prepared to be used in said election, on which ballots shall be printed the names of the runoff candidates for the position of Mayor of the City of

Socorro and At-Large and District No. 4 Representatives. The ballots, and such other materials as may be required by Chapter 272 of the Texas Election Code, shall be printed in English and in Spanish for use in said general election.

SECTION 3.

DRAWING FOR PLACES ON THE BALLOT.

Pursuant to Section 52.094 of the Texas Election Code, the order of the candidates' names for the general election were determined by a drawing. The order of the candidates' names on the ballot of said resulting runoff election shall be the relative order of names on the original election ballot, pursuant to Section 52.094(a) of the Texas Election Code.

SECTION 4.

EARLY VOTING CLERK.

- (a) The El Paso County Elections Administrator shall serve as the Early Voting Clerk. The official mailing address is:
500 E. San Antonio Ave., Suite #314
El Paso, Texas 79901
Facsimile No.: (915) 546-2220
E-mail: ballotrequests@epcounty.com
- (b) The City Secretary of the City of Socorro shall serve as Chief Deputy Early Voting Clerk.
- (c) Applications for ballot by mail shall be mailed, faxed, or e-mailed to the Early Voting Clerk at the address, facsimile number, or e-mail address set out in subsection (a) above. The electronic transmission of a scanned application must contain an original signature. Pursuant to section 84.007 of the Texas Election Code, an application for ballot by mail that is submitted via facsimile or e-mail must also be submitted via mail and received at the address in subsection (a) above, no later than the fourth business day after the request is sent via facsimile or email.
- (d) Applications for ballot by mail must be received no later than the close of regular business in the Early Voting Clerk's office, or 12 noon, whichever is later, on December 1, 2020, pursuant to section 84.007 of the Texas Election Code, except as otherwise provided by law. The date of submission of the scanned and e-mailed application for ballot by mail is determined by the date and time the e-mail was sent by the applicant. Late ballot voting shall be conducted pursuant to chapters 102 and 103 of the Election Code.

**SECTION 5.
EARLY POLLING LOCATIONS.**

Early voting shall be conducted at the locations and on the dates and times set forth in Exhibit "A," attached hereto and made a part hereof.

**SECTION 6.
ELECTION DAY POLLING LOCATIONS.**

Voting on Election Day shall be conducted at the polling places set forth in Exhibit "B," attached hereto and made a part hereof. The Election Day polling places shall be kept open on December 12, 2020, from 7:00 a.m. to 7:00 p.m.

**SECTION 7.
VOTING SYSTEM.**

- (a) An electronic voting system, as defined in Chapter 121 of the Texas Election Code, shall be used for voting at the polling places at said election and for counting the ballots and the tabulation of the results. The conduct of the election and the use of the electronic voting system shall be in accordance with the Texas Election Code. The voting system shall be accessible to disabled voters, pursuant to Chapter 61 of the Texas Election Code.
- (b) The El Paso County Elections Department, 500 E. San Antonio Ave., Suite #314, El Paso, Texas 79901, is hereby established as the Central Counting Station for the ballots cast in said election.
- (c) An individual having knowledge and experience in the conduct of elections with the electronic voting system for which the Central Counting Station is established shall be appointed by the El Paso County Elections Department as the Manager of the Central Counting Station. The Manager shall be in charge of overall administration of the Central Counting Station and the general supervision of the personnel working at the Station.
- (d) An individual, trained in the operation of the automatic tabulating equipment installed at the Central Counting Station, shall be appointed by El Paso County Elections Department as Tabulation Supervisor. The Tabulation Supervisor shall be in charge of the operation of the automatic tabulating equipment.
- (e) An individual shall be appointed by the El Paso County Elections Department as Assistant to the Tabulation Supervisor. Such assistant shall assist the Tabulation Supervisor in the operation of the automatic tabulating equipment as directed by the Tabulation Supervisor.

- (f) An individual shall be appointed by the El Paso County Elections Department as Presiding Judge of the Central Counting Station. He shall maintain order at the Central Counting Station and shall have such authority as may be prescribed by the Texas Election Code.
- (g) Due returns shall be made to the City Council showing the number of votes cast for each candidate for each office.

SECTION 8.
ELECTION BY MAJORITY.

The candidate receiving the majority of votes cast for the office for which he or she is a candidate shall be elected to such office. A tie vote shall be resolved pursuant to the Texas Election Code.

SECTION 9.
PROCLAMATION.

This order shall constitute the proclamation, call, notice and ordinance calling and ordering said election.

SECTION 10.
PUBLICATION.

Notice of said election shall be given by publishing a Notice of Election, in English and in Spanish, not earlier than the 30th day or later than the 10th day before Election Day in a newspaper of general circulation in said City, pursuant to section 4.003(a)(1) of the Texas Election Code.

A copy of the notice of this election shall be posted on the City's board used for posting notices of the meeting of the Socorro City Council not later than the 15th day before Election Day, and shall remain posted continuously through Election Day, pursuant to sections 4.003(b) and 2.026 of the Texas Election Code.

Notice of this election shall also be posted on the City of Socorro website.

SECTION 11.
NOTICE.

That the way and manner of holding said election, the notice to be given therefor, the polling places, the personnel and the officers who are to hold same, and all details connected with the holding of the election shall be provided for and arranged by the City Clerk; that the proper notice and publication of this notice, proclamation, call and ordinance shall be only cumulative of and in addition to the statutory notice of said election as herein provided; and that any omission or irregularity in this notice or in the publication or posting

of this notice, proclamation, call and ordinance, or in the signing of same, shall not in any way affect or invalidate such election.

**SECTION 12.
CONTROLLING LAW.**

That in all respects, said election shall be conducted in accordance with the Texas Constitution, Texas Election Code, and the applicable conforming provisions of the Charter and ordinances of the City of Socorro.

**SECTION 13.
OPEN MEETING COMPLIANCE.**

That it is hereby officially found and determined that the meeting at which this order was adopted and said election was called was open to the public and public notice of the time, place and purpose of said meeting was given, all as required by Chapter 551 of the Texas Government Code.

**SECTION 14.
EFFECTIVE DATE.**

That this election order, proclamation, call and notice shall take effect upon adoption.

CITY OF SOCORRO, TEXAS

By: _____
Elia Garcia, Mayor

ATTEST:

Olivia Navarro, City Clerk

APPROVED AS TO FORM AND LEGALITY:

James A. Martinez, City Attorney

ADOPTED and EFFECTIVE: November 12, 2020.

EXHIBIT "A"

CITY OF SOCORRO DECEMBER 12, 2020, ELECTION

EARLY VOTING BY PERSONAL APPEARANCE DAYS AND HOURS

Early Voting. Early voting by personal appearance shall be conducted on the attached dates and times and at the following locations, but may be subject to change.

November 25-December 8, 2020 (except November 26 and 27, 2020 in observance of Thanksgiving)

See attached Exhibit

***And such other locations, dates, and hours, as may be maintained by the El Paso County Elections Administrator.**

December 2020 Runoff Election

#govoteep



CLICK HERE for a picture of site

EARLY VOTING PERIOD: November 25 – December 8 EARLY VOTING STATIONS

CLICK HERE for directions to site

Station Name	Address	Hours
(Main Early Voting Station) 1. El Paso County Courthouse Third Floor, Back Lobby	500 E. San Antonio Ave. 79901	Wednesday, Nov. 25: 8am – 5pm Thursday, Nov. 26 - Friday, Nov. 27: CLOSED Saturday, Nov. 28 - Sunday, Nov. 29: 12pm – 5pm Monday, Nov. 30 - Friday, Dec. 4: 8am – 5pm Saturday, Dec. 5 - Sunday, Dec. 6: 12pm – 5pm Monday, Dec. 7 - Tuesday, Dec. 8: 7am – 7pm
2. Arlington Park Shelter Main Hall	10350 Pasadena Cir. 79924	Wednesday, Nov. 25: 9am – 6pm Thursday, Nov. 26 - Friday, Nov. 27: CLOSED Saturday, Nov. 28 - Sunday, Nov. 29: 12pm – 5pm Monday, Nov. 30 - Friday, Dec. 4: 9am – 6pm Saturday, Dec. 5 - Sunday, Dec. 6: 12pm – 5pm Monday, Dec. 7 - Tuesday, Dec. 8: 9am – 6pm
3. Bassett Place Next to Bath & Body Works	6101 Gateway West 79925	Wednesday, Nov. 25: 9am – 6pm Thursday, Nov. 26 - Friday, Nov. 27: CLOSED Saturday, Nov. 28 - Sunday, Nov. 29: 12pm – 5pm Monday, Nov. 30 - Friday, Dec. 4: 9am – 6pm Saturday, Dec. 5 - Sunday, Dec. 6: 12pm – 5pm Monday, Dec. 7 - Tuesday, Dec. 8: 9am – 6pm
4. Bowling Family YMCA Vita Room	5509 Will Ruth Ave. 79924	Wednesday, Nov. 25: 9am – 6pm Thursday, Nov. 26 - Friday, Nov. 27: CLOSED Saturday, Nov. 28 - Sunday, Nov. 29: 12pm – 5pm Monday, Nov. 30 - Friday, Dec. 4: 9am – 6pm Saturday, Dec. 5 - Sunday, Dec. 6: 12pm – 5pm Monday, Dec. 7 - Tuesday, Dec. 8: 9am – 6pm

Note: Early Voting Stations, dates, and times are subject to change at any time. Any registered voter may vote at any Early Voting Station. Click on an address for a street view via Google Maps or click on a location name to view a picture to that specific site. For more information visit epcountyvotes.com or call (915) 546-2154.

EARLY VOTING PERIOD: November 25 – December 8

EARLY VOTING STATIONS

5. <u>Canutillo ISD Administration Facility</u> Boardroom	7965 Artcraft Rd. 79932	Wednesday, Nov. 25 Thursday, Nov. 26 - Friday, Nov. 27 Saturday, Nov. 28 - Sunday, Nov. 29 Monday, Nov. 30 - Friday, Dec. 4 Saturday, Dec. 5 - Sunday, Dec. 6 Monday, Dec. 7 - Tuesday, Dec. 8	8am – 5pm CLOSED 12pm – 5pm 8am – 5pm 12pm – 5pm 8am – 5pm
6. <u>Chayo Apodaca Community Center</u> Community Center	341 N. Moon Rd. 79927	Wednesday, Nov. 25 Thursday, Nov. 26 - Friday, Nov. 27 Saturday, Nov. 28 - Sunday, Nov. 29 Monday, Nov. 30 - Friday, Dec. 4 Saturday, Dec. 5 - Sunday, Dec. 6 Monday, Dec. 7 - Tuesday, Dec. 8	9am – 6pm CLOSED 12pm – 5pm 9am – 6pm 12pm – 5pm 9am – 6pm
7. <u>Commissioner's Corner</u> Community Room	10700 Montana Ave. 79936	Wednesday, Nov. 25 Thursday, Nov. 26 - Friday, Nov. 27 Saturday, Nov. 28 - Sunday, Nov. 29 Monday, Nov. 30 - Friday, Dec. 4 Saturday, Dec. 5 - Sunday, Dec. 6 Monday, Dec. 7 - Tuesday, Dec. 8	9am – 6pm CLOSED 12pm – 5pm 9am – 6pm 12pm – 5pm 9am – 6pm
8. <u>Dorris Van Doren Library</u> Auditorium	551 Redd Rd. 79912	Wednesday, Nov. 25 Thursday, Nov. 26 - Friday, Nov. 27 Saturday, Nov. 28 - Sunday, Nov. 29 Monday, Nov. 30 - Friday, Dec. 4 Saturday, Dec. 5 - Sunday, Dec. 6 Monday, Dec. 7 - Tuesday, Dec. 8	10am – 7pm CLOSED 12pm – 5pm 10am – 7pm 12pm – 5pm 10am – 7pm
9. <u>El Paso County Coliseum</u> Main Floor	4100 E. Paisano Dr. 79905	Wednesday, Nov. 25 Thursday, Nov. 26 - Friday, Nov. 27 Saturday, Nov. 28 - Sunday, Nov. 29 Monday, Nov. 30 - Friday, Dec. 4 Saturday, Dec. 5 - Sunday, Dec. 6 Monday, Dec. 7 - Tuesday, Dec. 8	9am – 6pm CLOSED 12pm – 5pm 9am – 6pm 12pm – 5pm 9am – 6pm

Note: Early Voting Stations, dates, and times are subject to change at any time. Any registered voter may vote at any Early Voting Station. Click on an address for a street view via Google Maps or click on a location name to view a picture to that specific site. For more information visit epcountyvotes.com or call (915) 546-2154.

EARLY VOTING PERIOD: November 25 – December 8

EARLY VOTING STATIONS

<p>10. El Paso County Eastside Annex Community Room</p>	<p>2350 George Dieter Dr. 79936</p>	<p>Wednesday, Nov. 25 Thursday, Nov. 26 - Friday, Nov. 27 Saturday, Nov. 28 - Sunday, Nov. 29 Monday, Nov. 30 - Friday, Dec. 4 Saturday, Dec. 5 - Sunday, Dec. 6 Monday, Dec. 7 - Tuesday, Dec. 8</p>	<p>8am – 6pm CLOSED 12pm – 5pm 8am – 6pm 12pm – 5pm 8am – 6pm</p>
<p>11. El Paso County Northwest Annex Community Room</p>	<p>435 E. Vinton Rd. 79821</p>	<p>Wednesday, Nov. 25 Thursday, Nov. 26 - Friday, Nov. 27 Saturday, Nov. 28 - Sunday, Nov. 29 Monday, Nov. 30 - Friday, Dec. 4 Saturday, Dec. 5 - Sunday, Dec. 6 Monday, Dec. 7 - Tuesday, Dec. 8</p>	<p>8am – 6pm CLOSED 12pm – 5pm 8am – 6pm 12pm – 5pm 8am – 6pm</p>
<p>12. EPCC Administrative Services Center Auditorium</p>	<p>9050 Viscount Blvd. 79925</p>	<p>Wednesday, Nov. 25 Thursday, Nov. 26 - Friday, Nov. 27 Saturday, Nov. 28 - Sunday, Nov. 29 Monday, Nov. 30 - Friday, Dec. 4 Saturday, Dec. 5 - Sunday, Dec. 6 Monday, Dec. 7 - Tuesday, Dec. 8</p>	<p>8am – 5pm CLOSED 12pm – 5pm 8am – 5pm 12pm – 5pm 8am – 5pm</p>
<p>13. Esperanza Acosta Moreno Library Meeting Room</p>	<p>12480 Pebble Hills Blvd. 79938</p>	<p>Wednesday, Nov. 25 Thursday, Nov. 26 - Friday, Nov. 27 Saturday, Nov. 28 - Sunday, Nov. 29 Monday, Nov. 30 - Friday, Dec. 4 Saturday, Dec. 5 - Sunday, Dec. 6 Monday, Dec. 7 - Tuesday, Dec. 8</p>	<p>10am – 7pm CLOSED 12pm – 5pm 10am – 7pm 12pm – 5pm 10am – 7pm</p>
<p>14. Family Youth Services Center Lobby</p>	<p>6314 Delta Dr. 79905</p>	<p>Wednesday, Nov. 25 Thursday, Nov. 26 - Friday, Nov. 27 Saturday, Nov. 28 - Sunday, Nov. 29 Monday, Nov. 30 - Friday, Dec. 4 Saturday, Dec. 5 - Sunday, Dec. 6 Monday, Dec. 7 - Tuesday, Dec. 8</p>	<p>8am – 5pm CLOSED 12pm – 5pm 8am – 5pm 12pm – 5pm 8am – 5pm</p>

Note: Early Voting Stations, dates, and times are subject to change at any time. Any registered voter may vote at any Early Voting Station. Click on an address for a street view via Google Maps or click on a location name to view a picture to that specific site. For more information visit epcountyvotes.com or call (915) 546-2154.

EARLY VOTING PERIOD: November 25 – December 8

EARLY VOTING STATIONS

15. <u>Gonzalez Place</u> Community Room	4101 Rich Beem Blvd. 79938	Wednesday, Nov. 25 Thursday, Nov. 26 - Friday, Nov. 27 Saturday, Nov. 28 - Sunday, Nov. 29 Monday, Nov. 30 - Friday, Dec. 4 Saturday, Dec. 5 - Sunday, Dec. 6 Monday, Dec. 7 - Tuesday, Dec. 8	8am – 5pm CLOSED 12pm – 5pm 8am – 5pm 12pm – 5pm 8am – 5pm
16. <u>Grandview Park Senior Citizen Center</u> Main Hall	3134 Jefferson Ave. 79930	Wednesday, Nov. 25 Thursday, Nov. 26 - Friday, Nov. 27 Saturday, Nov. 28 - Sunday, Nov. 29 Monday, Nov. 30 - Friday, Dec. 4 Saturday, Dec. 5 - Sunday, Dec. 6 Monday, Dec. 7 - Tuesday, Dec. 8	8am – 5pm CLOSED 12pm – 5pm 8am – 5pm 12pm – 5pm 8am – 5pm
17. <u>Marty Robbins Recreation Center</u> Multi-Purpose Room	11620 Vista Del Sol Dr. 79936	Wednesday, Nov. 25 Thursday, Nov. 26 - Friday, Nov. 27 Saturday, Nov. 28 - Sunday, Nov. 29 Monday, Nov. 30 - Friday, Dec. 4 Saturday, Dec. 5 - Sunday, Dec. 6 Monday, Dec. 7 - Tuesday, Dec. 8	9am – 6pm CLOSED 12pm – 5pm 9am – 6pm 12pm – 5pm 9am – 6pm
18. <u>Mountain View-Rae Gilmore Recreation Center</u> Multi-Purpose Room	8501 Diana Dr. 79904	Wednesday, Nov. 25 Thursday, Nov. 26 - Friday, Nov. 27 Saturday, Nov. 28 - Sunday, Nov. 29 Monday, Nov. 30 - Friday, Dec. 4 Saturday, Dec. 5 - Sunday, Dec. 6 Monday, Dec. 7 - Tuesday, Dec. 8	10am – 7pm CLOSED 12pm – 5pm 10am – 7pm 12pm – 5pm 10am – 7pm
19. <u>Nations Tobin Sports Center</u> Small Rink	8831 Railroad Dr. 79904	Wednesday, Nov. 25 Thursday, Nov. 26 - Friday, Nov. 27 Saturday, Nov. 28 - Sunday, Nov. 29 Monday, Nov. 30 - Friday, Dec. 4 Saturday, Dec. 5 - Sunday, Dec. 6 Monday, Dec. 7 - Tuesday, Dec. 8	9am – 6pm CLOSED 12pm – 5pm 9am – 6pm 12pm – 5pm 9am – 6pm

Note: Early Voting Stations, dates, and times are subject to change at any time. Any registered voter may vote at any Early Voting Station. Click on an address for a street view via Google Maps or click on a location name to view a picture to that specific site. For more information visit epcountyvotes.com or call (915) 546-2154.

EARLY VOTING PERIOD: November 25 – December 8

EARLY VOTING STATIONS

<p>20. <u>Officer David Ortiz Recreation Center</u> 563 N. Carolina Dr. 79915 Connect Classroom</p>	<p>Wednesday, Nov. 25 Thursday, Nov. 26 - Friday, Nov. 27 Saturday, Nov. 28 - Sunday, Nov. 29 Monday, Nov. 30 - Friday, Dec. 4 Saturday, Dec. 5 - Sunday, Dec. 6 Monday, Dec. 7 - Tuesday, Dec. 8</p>	<p>9am – 6pm CLOSED 12pm – 5pm 9am – 6pm 12pm – 5pm 9am – 6pm</p>
<p>21. <u>Pavo Real Recreation Center</u> 9301 Alameda Ave. 79907 Auxiliary Gym</p>	<p>Wednesday, Nov. 25 Thursday, Nov. 26 - Friday, Nov. 27 Saturday, Nov. 28 - Sunday, Nov. 29 Monday, Nov. 30 - Friday, Dec. 4 Saturday, Dec. 5 - Sunday, Dec. 6 Monday, Dec. 7 - Tuesday, Dec. 8</p>	<p>9am – 6pm CLOSED 12pm – 5pm 9am – 6pm 12pm – 5pm 9am – 6pm</p>
<p>22. <u>Pebble Hills High School</u> 14400 Pebble Hills Blvd. 79938 Auditorium Foyer</p>	<p>Wednesday, Nov. 25 Thursday, Nov. 26 - Friday, Nov. 27 Saturday, Nov. 28 - Sunday, Nov. 29 Monday, Nov. 30 - Friday, Dec. 4 Saturday, Dec. 5 - Sunday, Dec. 6 Monday, Dec. 7 - Tuesday, Dec. 8</p>	<p>8am – 5pm CLOSED 12pm – 5pm 8am – 5pm 12pm – 5pm 8am – 5pm</p>
<p>23. <u>South El Paso Senior Citizens Center</u> 600 S. Ochoa St. 79901 Classroom 1 & 2</p>	<p>Wednesday, Nov. 25 Thursday, Nov. 26 - Friday, Nov. 27 Saturday, Nov. 28 - Sunday, Nov. 29 Monday, Nov. 30 - Friday, Dec. 4 Saturday, Dec. 5 - Sunday, Dec. 6 Monday, Dec. 7 - Tuesday, Dec. 8</p>	<p>8am – 5pm CLOSED 12pm – 5pm 8am – 5pm 12pm – 5pm 8am – 5pm</p>
<p>24. <u>Sunland Park Mall</u> 750 Sunland Park Dr. 79912 *TBD</p>	<p>Wednesday, Nov. 25 Thursday, Nov. 26 - Friday, Nov. 27 Saturday, Nov. 28 - Sunday, Nov. 29 Monday, Nov. 30 - Friday, Dec. 4 Saturday, Dec. 5 - Sunday, Dec. 6 Monday, Dec. 7 - Tuesday, Dec. 8</p>	<p>9am – 6pm CLOSED 12pm – 5pm 9am – 6pm 12pm – 5pm 9am – 6pm</p>

Note: Early Voting Stations, dates, and times are subject to change at any time. Any registered voter may vote at any Early Voting Station. Click on an address for a street view via Google Maps or click on a location name to view a picture to that specific site. For more information visit epcountyvotes.com or call (915) 546-2154.

EARLY VOTING PERIOD: November 25 – December 8

EARLY VOTING STATIONS

25. <u>UTEP – Union Building East Wing</u> *TBD	351 W. University Ave. 79902	Wednesday, Nov. 25 Thursday, Nov. 26 - Friday, Nov. 27 Saturday, Nov. 28 - Sunday, Nov. 29 Monday, Nov. 30 - Friday, Dec. 4 Saturday, Dec. 5 - Sunday, Dec. 6 Monday, Dec. 7 - Tuesday, Dec. 8	8am – 5pm CLOSED 12pm – 5pm 8am – 5pm 12pm – 5pm 8am – 5pm
26. <u>Wellington Chew Senior Center</u> Main Room	4430 Maxwell Ave. 79904	Wednesday, Nov. 25 Thursday, Nov. 26 - Friday, Nov. 27 Saturday, Nov. 28 - Sunday, Nov. 29 Monday, Nov. 30 - Friday, Dec. 4 Saturday, Dec. 5 - Sunday, Dec. 6 Monday, Dec. 7 - Tuesday, Dec. 8	8am – 5pm CLOSED 12pm – 5pm 8am – 5pm 12pm – 5pm 8am – 5pm
27. <u>YWCA-East</u> Lobby	10712 Sam Snead Dr. 79935	Wednesday, Nov. 25 Thursday, Nov. 26 - Friday, Nov. 27 Saturday, Nov. 28 - Sunday, Nov. 29 Monday, Nov. 30 - Friday, Dec. 4 Saturday, Dec. 5 - Sunday, Dec. 6 Monday, Dec. 7 - Tuesday, Dec. 8	9am – 6pm CLOSED 12pm – 5pm 9am – 6pm 12pm – 5pm 9am – 6pm
28. <u>YWCA-West</u> Program Offices Room	313 Bartlett Dr. 79912	Wednesday, Nov. 25 Thursday, Nov. 26 - Friday, Nov. 27 Saturday, Nov. 28 - Sunday, Nov. 29 Monday, Nov. 30 - Friday, Dec. 4 Saturday, Dec. 5 - Sunday, Dec. 6 Monday, Dec. 7 - Tuesday, Dec. 8	9am – 6pm CLOSED 12pm – 5pm 9am – 6pm 12pm – 5pm 9am – 6pm

Note: Early Voting Stations, dates, and times are subject to change at any time. Any registered voter may vote at any Early Voting Station. Click on an address for a street view via Google Maps or click on a location name to view a picture to that specific site. For more information visit epcountyvotes.com or call (915) 546-2154.

EXHIBIT "B"

CITY OF SOCORRO DECEMBER 12, 2020, ELECTION

See attachment

***And such other locations, dates, and hours, as may be maintained by the El Paso County Elections Administrator.**

December 2020 Runoff Election

Elección de Desempate de Diciembre de 2020



Election Day: Saturday, December 12, 2020
Día de Elección: Sábado, 12 de Diciembre de 2020
7:00 a.m. - 7:00 p.m.

CLICK HERE for a picture of site
PRESIONE AQUÍ para ver imagen del lugar

You can now vote at any Vote Center on Election Day.
Ahora puede votar en cualquier Centro de Votación el Día de la Elección.

CLICK HERE for directions to site
PRESIONE AQUÍ para ver mapa del lugar

The Vote Centers are separated and numbered by Commissioner Precincts.

Los Centros de Votación están separados y enumerados por Precintos de Comisionado

Commissioner Precinct 1 *Precinto Comisario 1*

Precinct(s) Precincto(s)	Vote Center Centro de Votación	Address Dirección
1-90	Fire Station #20	8301 Edgemere Blvd. 79925
1-91	MacArthur Elementary/Intermediate School	8101 Whitus Dr. 79925
1-92	Cielo Vista Elementary School	9000 Basil Ct. 79925
1-93	Scotsdale Elementary School	2901 Mc Rae Blvd. 79925
1-94	Edgemere Elementary School	10300 Edgemere Blvd. 79925
1-96	Eastpoint Elementary School	2400 Zanzibar Rd. 79925
1-97	YISD Central Office	9600 Sims Dr. 79925
1-98	Eastwood Heights Elementary School	10530 Janway Dr. 79925
1-100	Pebble Hills Elementary School	11145 Edgemere Blvd. 79936
1-102	YWCA-East	10712 Sam Snead Dr. 79935
1-103	Vista Hills Elementary School	10801 La Subida Dr. 79935
1-104	Fred & Maria Loya Family YMCA	2044 Trawood Dr. 79935
1-106(a)	El Paso County Eastside Annex	2350 George Dieter Dr. 79936
1-106(b)	Glen Cove Elementary School	10955 Sam Snead Dr. 79936
1-107	Hanks High School	2001 Lee Trevino Dr. 79936

1-108	Tierra Del Sol Elementary School	1832 Tommy Aaron Dr. 79936
1-109	Desert View Middle School	1641 Billie Marie Dr. 79936
1-110	ESC Region 19 Head Start Multipurpose Center	11670 Chito Samaniego Dr. 79936
1-112	Jane Hambric K-8 School	3535 Nolan Richardson Dr. 79936
1-113	Bill Sybert K-8 School	11530 Edgemere Blvd. 79936
1-115	Hurshel Antwine Elementary School	3830 Rich Beem Blvd. 79938
1-116(a)	Esperanza Acosta Moreno Library	12480 Pebble Hills Blvd. 79938
1-116(b)	Spc. Rafael Hernando III Middle School	3451 Rich Beem Blvd. 79938
1-117	Benito Martinez Elementary School	2640 Robert Wynn St. 79936
1-119	Helen Ball Elementary School	1950 Firehouse Dr. 79936
1-120	O'Shea Keleher Elementary School	1800 Leroy Bonse Dr. 79936
1-121	Montwood High School	12000 Montwood Dr. 79936
1-122	Vista Del Sol Elementary School	11851 Vista Del Sol Dr. 79936
1-123(a)	Marty Robbins Recreation Center	11620 Vista Del Sol Dr. 79936
1-123(b)	Myrtle Cooper Elementary School	1515 Rebecca Ann Dr. 79936
1-125	Sierra Vista Elementary School	1501 Bob Hope Dr. 79936
1-126	KEYS Academy	12380 Pine Springs Dr. 79928
1-130	Lujan-Chavez Elementary School	2200 Sun Country Dr. 79938

Commissioner Precinct 2

Precinto Comisario 2

Precinct(s) Precincto(s)	Vote Center Centro de Votación	Address Dirección
2-31	Sunland Park Mall	750 Sunland Park Dr. 79912
2-36	El Paso Community College-Rio Grande Campus	906 El Paso St. 79902
2-37(a)	El Paso County Courthouse	500 E. San Antonio Ave. 79901
2-37(b)	South El Paso Senior Citizens Center	600 S. Ochoa St. 79901
2-38	Fire Station #3	721 E. Rio Grande Ave. 79902
2-39	San Jacinto Adult Learning Center	1216 Olive Ave. 79901
2-40	Lamar Elementary School	1440 E. Cliff Dr. 79902
2-41	Center for Career and Technology Education	1170 N. Walnut St. 79930
2-42	Bowie High School	801 S. San Marcial St. 79905
2-50	Desertaire Elementary School	6301 Tiger Eye Dr. 79924
2-57(a)	Bowling Family YMCA	5509 Will Ruth Ave. 79924
2-57(b)	Fire Station #23	5315 Threadgill Ave. 79924
2-58	Dolphin Terrace Elementary School	9790 Pickerel Dr. 79924
2-59	Crosby Elementary School	5411 Wren Ave. 79924
2-63	Magoffin Middle School	4931 Hercules Ave. 79904
2-64(a)	Nations Tobin Sports Center	8831 Railroad Dr. 79904
2-64(b)	Stanton Elementary School	5414 Hondo Pass Dr. 79924
2-65	Logan Elementary School	3200 Ellerthorpe Ave. 79904
2-67	Travis Elementary School	5000 N. Stevens St. 79930
2-69	Grandview Park Senior Citizen Center	3134 Jefferson Ave. 79930
2-70	Paul C. Moreno Elementary School	2300 San Diego Ave. 79930
2-71	Memorial Park Senior Citizen Center	1800 Byron St. 79930
2-72	Austin High School	3500 Memphis Ave. 79930
2-74	Fire Station #7	3200 Pershing Dr. 79903
2-75	Cross of Grace Church	4700 Leeds Ave. 79903
2-77	Safety and Health Outreach Center	5415 Trowbridge Dr. 79903
2-79	Jefferson High School	4700 Alameda Ave. 79905

2-80	El Paso County Coliseum	4100 E. Paisano Dr. 79905
2-82	Hawkins Elementary School	5816 Stephenson Ave. 79905
2-83	Henderson Middle School	5505 Robert Alva Ave. 79905
2-84	Clardy Elementary School	5508 Delta Dr. 79905
2-85	El Paso County Ascarate Annex	301 Manny Martinez Dr. 79905
2-88	Ross Middle School	6101 Hughey Cir. 79925
2-89(a)	Bassett Place	6101 Gateway West 79925
2-89(b)	Bonham Elementary School	7024 Cielo Vista Dr. 79925
2-132	El Paso Community College-Valle Verde	919 Hunter Dr. 79915
2-133	Del Norte Heights Elementary School	1800 Winslow Rd. 79915
2-134	Ramona Elementary School	351 Nichols Rd. 79915
2-135	Ascarate Elementary School	7090 Alameda Ave. 79915
2-136	Cedar Grove Elementary School	218 Barker Rd. 79915
2-142	Riverside High School	301 Midway Dr. 79915
2-143	Ysleta Pre-K Center	7940 Craddock Ave. 79915

Commissioner Precinct 3

Precinto Comisario 3

Precinct(s) Precincto(s)	Vote Center Centro de Votación	Address Dirección
3-128	Pebble Hills High School	14400 Pebble Hills Blvd. 79938
3-137	Bel Air Middle School	7909 Ranchland Dr. 79915
3-138(a)	Hacienda Heights Elementary School	7530 Acapulco Ave. 79915
3-138(b)	Officer David Ortiz Recreation Center	563 N. Carolina Dr. 79915
3-139	Mesa Vista Elementary School	8032 Alamo Ave. 79907
3-140	North Loop Elementary School	412 Emerson St. 79915
3-144	Loma Terrace Elementary School	8200 Ryland Dr. 79907
3-147	Transition To Life Career Center	7988 Alameda Ave. 79915
3-150	YWCA-Lower Valley	115 Davis Dr. 79907
3-151	Capistrano Elementary School	240 Mecca Dr. 79907
3-153	Lancaster Elementary School	9230 Elgin Dr. 79907
3-154	Alicia R. Chacon International School **Formerly LeBarron Park Elementary School	920 Burgundy Dr. 79907
3-156	Pavo Real Recreation Center	9301 Alameda Ave. 79907
3-157(b)	Western Technical College	9624 Plaza Cir. 79927
3-160(a)	El Paso Community College-Mission Del Paso	10700 Gateway Blvd E. 79927
3-160(b)	H.D. Hilley Elementary School	693 N. Rio. Vista Rd. 79927
3-162	Chayo Apodaca Community Center	341 N. Moon Rd. 79927
3-163	Robert R. Rojas Elementary School	500 Bauman Rd. 79927
3-164	Escontrias Elementary School	205 Buford Rd. 79927
3-165	Campestre Elementary School	11399 Socorro Rd. 79927
3-170	Clint ISD Early College Academy	13100 Alameda Ave. 79836
3-180	Desert Wind K-8 School	1100 Colina De Paz Dr. 79928

Commissioner Precinct 4

Precinto Comisario 4

Precinct(s) Precincto(s)	Vote Center Centro de Votación	Address Dirección
4-2	El Paso County Northwest Annex	435 E. Vinton Rd. 79821
4-5(a)	El Paso Community College-Northwest	6701 S. Desert Blvd. 79932
4-5(b)	Fire Station #2	111 E. Borderland Rd. 79932
4-7	Community Connections Center	5300 Warriors Dr. 79932
4-8	Fire Station #15	115 Shorty Ln. 79922
4-9	Zach White Elementary School	4256 Roxbury Dr. 79922
4-10	Roberts Elementary School	341 Thorn Ave. 79932
4-11(a)	Brown Middle School	7820 Helen of Troy Dr. 79912
4-11(b)	Dorris Van Doren Library	551 Redd Rd. 79912
4-12	Congressman Silvestre & Carolina Reyes School	7440 Northern Pass Dr. 79911
4-13	Franklin Magnet Center	825 E. Redd Rd. 79912
4-14	Tippin Elementary School	6541 Bear Ridge Dr. 79912
4-15	Fire Station #27	6767 Ojo De Agua Dr. 79912
4-16	Rosa Guerrero Elementary School	7530 Lakehurst Rd. 79912
4-17	Franklin High School	900 N. Resler Dr. 79912
4-19	YWCA - West	313 Bartlett Dr. 79912
4-23	Carlos Rivera Elementary School	6445 Escondido Dr. 79912
4-24	Western Hills U.M.C.-Stewart Family Life Center A	524 Thunderbird Dr. 79912
4-25	Dr. Green Elementary School	5430 Buckley Dr. 79912
4-26	Putnam Elementary School	6508 Fiesta Dr. 79912
4-29	L. B. Johnson Elementary School	499 Cabaret Dr. 79912
4-33	Mesita Elementary School	3307 N. Stanton St. 79902
4-35(a)	El Paso Tennis Club	2510 N. St. Vrain St. 79902
4-35(b)	UTEP - Union Building East Wing	351 W. University Ave. 79902
4-44	Dr. Nixon Elementary School	11141 Loma Roja Dr. 79934
4-46	Dr. Joseph E. Torres Elementary School **Formerly Bradley Elementary School	10700 Rushing Rd. 79924

4-47	H.E. Charles Middle School	4909 Trojan Dr. 79924
4-51	Arlington Park Shelter	10350 Pasadena Cir. 79924
4-52	Collins Elementary School	4860 Tropicana Ave. 79924
4-53	Newman Elementary School	10275 Alcan St. 79924
4-54	Parkland High School	5932 Quail Ave. 79924
4-55(a)	El Paso Community College-Transmountain	9570 Gateway N Blvd. 79924
4-55(b)	Whitaker Elementary School	4700 Rutherford Dr. 79924
4-56	Dowell Elementary School	5249 Bastille Ave. 79924
4-61	Park Elementary School	3601 Edgar Park Ave. 79904
4-176	Polk Elementary School	940 Belvidere St. 79912
4-186	Fire Station #16	3828 Hercules Ave. 79904

Note: Vote Centers are subject to change at any time. Click on an address for directions via Google Maps or click on a location name to view a picture picture to that specific site. For more election information visit epcountyvotes.com or call (915) 546-2154.

Nota: Centros de Votación están sujetos a cambio en cualquier momento. Para ver mapa del lugar, presione en la dirección del Lugar de Votación de su preferencia via Google Maps o para ver una imagen del lugar, presione en el nombre del Lugar de Votación de su preferencia. Para más información visite epcountyvotes.com o llame (915) 546-2154.

EXHIBIT "A"

CITY OF SOCORRO DECEMBER 12, 2020, ELECTION

EARLY VOTING BY PERSONAL APPEARANCE DAYS AND HOURS

Early Voting. Early voting by personal appearance shall be conducted on the attached dates and times and at the following locations, but may be subject to change.

November 25-December 8, 2020 (except November 26 and 27, 2020 in observance of Thanksgiving)

See attachment

***And such other locations, dates, and hours, as may be maintained by the El Paso County Elections Administrator.**